







# Torque Tools

For torque-controlled screw tightening



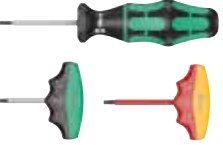

# Torque Tools

	Adjustable Torque Screwdrivers Series 7400	<b>14</b>
	Pre-set, Adjustable Torque Screwdrivers Series 7400	<b>30</b>
	Torque-indicators	<b>36</b>
	Series Click-Torque Wrenches with reversible ratchet	<b>42</b>
	Series Click-Torque Wrenches for insert tools	<b>52</b>
	Series Click-Torque Wrenches pre-set for insert tools	<b>55</b>
	Series Insert Tools	<b>58</b>

Weka

BE A

TOOL

REBEL



# What we believe in ...

We believe in challenging the standard

We believe in thinking in a rebellious way

We believe in Rock'n'Roll

We love to be Tool Rebels

The way we challenge the standard is ...

by making the experience for our users ...

**easier, safer and full of joy.**

We simply create great tools for rebels.

# BE A TOOL REBEL



# Wera Tools

Passionate staff and a considerable degree of vertical manufacturing integration ensure an unmatched level of tool know-how.



Logistics Center Wera Werkzeuge GmbH, Wuppertal





Production plant, Wera Werk Bystřice



# Wera Werkzeuge GmbH – Calibration competence in our own laboratory in Wuppertal

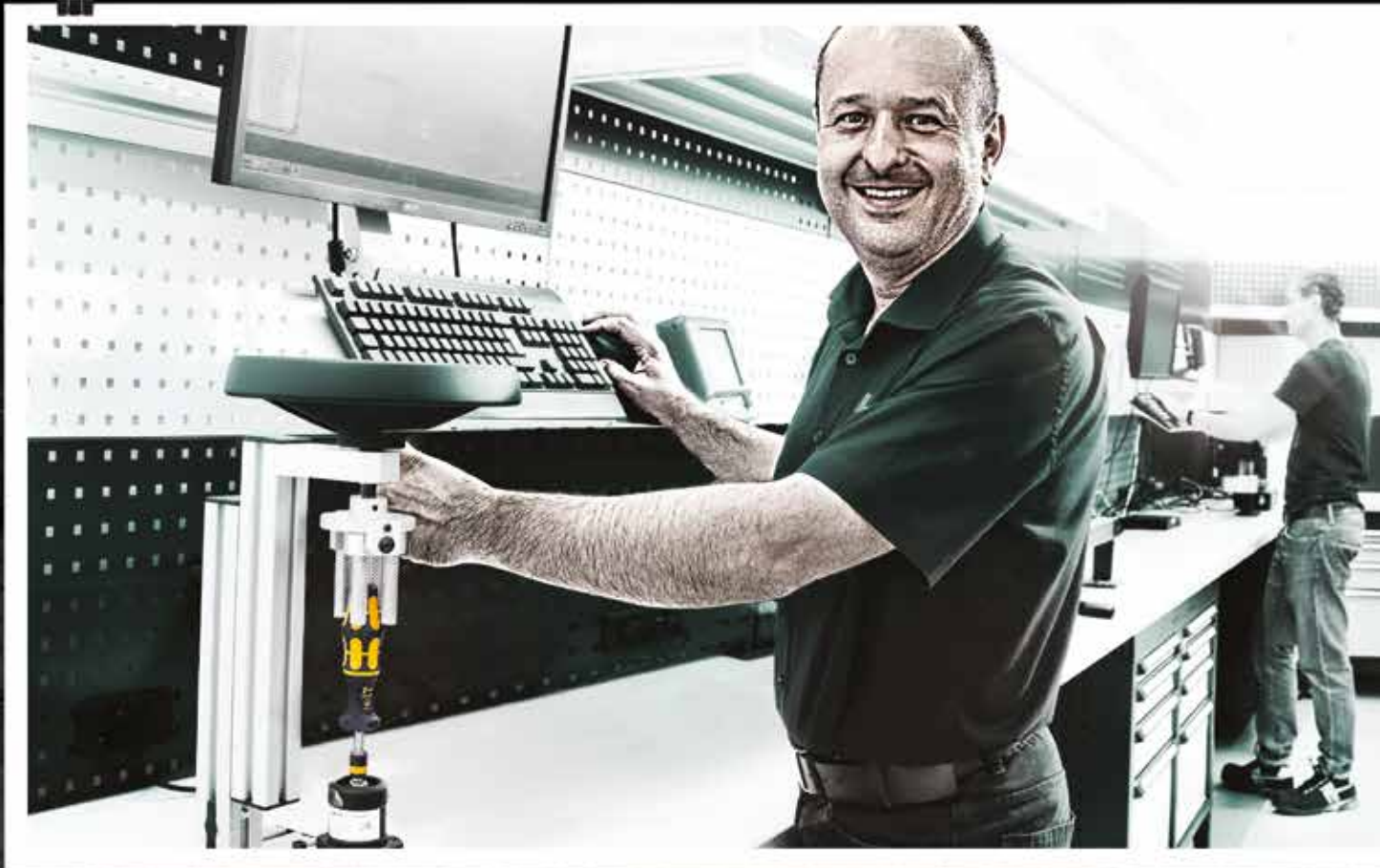

Comprehensive range of services: calibration, adjustment, repair and certification of Wera torque tools.



The Wera torque tools are produced, adjusted, calibrated and certified under strict quality conditions. On request, Wera can also issue a calibration certificate according to DAkkS guidelines in cooperation with an accredited specialist laboratory.



The Wera Torque Service offers you excellent and affordable service packages with short delivery times and will be happy to answer your questions about your torque tool.



Production plant, Wera Werk Bystřice



Factory calibration.



Personal contact and competent advice.

# Torque Tools

Wera's torque tools offer torque-controlled screw tightening so as to avoid damage to the screw or workpiece and to ensure the integrity of the screw connection. This makes work-intensive drilling-out of screws and unproductive downtimes a thing of the past. It is also important whenever repeat accuracy is required.

They come with an ergonomic Kraftform handle and have a distinctly audible and perceptible click signal whenever the required torque value is reached.

No time-consuming blade changes; instead of special blades, conventional bits conforming to C 6,3 and E 6,3 or even 1/4" sockets can be used.



## Adjustable torque screwdrivers

They can be adjusted by hand to the corresponding scale value. Also available in ESD version (also with take-up for HIOS/Halfmoon bits) and with Kraftform Micro handle. See page 14.  
For the insulated VDE-version see page 22.

## Pre-set, adjustable torque screwdrivers

Pre-set torque, adjustable within a defined range. Also available in ESD version (also with take-up for HIOS/Halfmoon bits) and with Kraftform Micro handle. See page 30.



### Torque-indicators

Suitable for applications requiring a non-adjustable i.e. a tamperproof torque blade assembly.  
See page 36.

### Series Click-Torque wrenches

Suitable for controlled tightening using sockets and bits.  
See page 42.

# Adjustable Torque Screwdrivers

Wera's adjustable torque screwdrivers allow variable torque settings with maximum precision and ensure that the user gets the very best results in the familiar Wera design with superior ergonomics.



Simple setting of the required torque by hand.



Easy-to-read scale value.



Measurement accuracy is  $\pm 6\%$  (article 1430:  $\pm 10\%$ ) in accordance with the standard DIN EN ISO 6789. Distinctly audible and noticeable excess-load signal when the pre-set torque is reached.

All Wera torque screwdrivers manufactured according to DIN EN ISO 6789 are supplied with a Declaration of conformity. Our workshop offers a comprehensive service for all Wera torque tools. Please contact us with any queries regarding service, recalibration or repair on +49 (0)202 40 45 145; Fax: +49 (0)202 40 45 158 or per E-Mail at: [torqueservice@wera.de](mailto:torqueservice@wera.de).



Articles 7430, 7431, 7432, 7430 ESD, 7431 ESD, 7432 ESD, 7435 ESD, 7436 ESD, 1430 ESD and 1431 ESD all come with a magnifying glass. This can be easily attached on to the scale, dramatically improving visibility.



Unlimited torque for loosening seized screws.



Multi-component Kraftform handle with hard and soft zones for fast working speeds and protecting the palm of the hand.

# Series 7400 Kraftform Torque Screwdrivers

## Variable torque adjustment models

### Series 7400 Kraftform adjustable torque screwdrivers (0.1-3.0 Nm) with Rapidaptor quick-release chuck



**Application:** Suitable for 1/4" DIN ISO 1173-C 6,3 and E 6,3 hexagon insert bits and Wera Series 1 and 4

**Design:** Rapidaptor rapid-in, rapid-out, rapid-spin, chuck-all and single-hand technology

**Accuracy:** ±6 % (DIN EN ISO 6789). Numerical torque value scale. Reliable slipping mechanism and acoustic signal when reaching the set torque.

**Handle:** Kraftform with non-roll feature, multi-component

### Series 7400 Kraftform pistol grip, adjustable torque screwdrivers (3.0-8.8 Nm) with Rapidaptor quick-release chuck



**Application:** Suitable for 1/4" DIN ISO 1173-C 6,3 and E 6,3 hexagon insert bits and Wera Series 1 and 4

**Design:** Rapidaptor rapid-in, rapid-out, rapid-spin, chuck-all and single-hand technology

**Accuracy:** ±6 % (DIN EN ISO 6789). Numerical torque value scale. Reliable slipping mechanism and acoustic signal when reaching the set torque.

**Handle:** Kraftform pistol grip, multi-component

	Art.No.	mm	1/4"	Nm	Nm	mm	mm
05074770001 <sup>1)</sup>	7430	89	1/4"	0,10-0,34	0,015	142	5 7/16"
05074772001 <sup>1)</sup>	7431	89	1/4"	0,30-1,00	0,05	142	5 7/16"
05074774001 <sup>1)</sup>	7432	89	1/4"	0,90-1,50	0,05	142	5 7/16"
05074700001	7440	105	1/4"	0,3-1,2	0,05	155	6"
05074701001	7441	105	1/4"	1,2-3,0	0,10	155	6"

<sup>1)</sup> With attachable magnifying glass, dramatically improving visibility.

	Art.No.	1/4"	Nm	Nm	mm	mm	mm
05074702001	7442	1/4"	3,0-6,0	0,25	150	100	4"
05074705001	7443	1/4"	4,0-8,8	0,40	150	100	4"

**Series 7400 Kraftform ESD adjustable torque screwdrivers (0.1-3.0 Nm) with Rapidaptor quick-release chuck**



**Application:** Suitable for 1/4" DIN ISO 1173-C 6,3 and E 6,3 hexagon insert bits and Wera Series 1 and 4

**Design:** Rapidaptor rapid-in, rapid-out, rapid-spin, chuck-all and single-hand technology, non-magnetic

**Accuracy:** ±6 % (DIN EN ISO 6789). Numerical torque value scale. Reliable slipping mechanism and acoustic signal when reaching the set torque.

**Handle:** Kraftform with non-roll feature, multi-component

	Art.No.	mm					
			Nm	Nm	mm		
05074780001 <sup>1)</sup>	7430 ESD	89	1/4"	0,10-0,34	0,015	142	5 7/16"
05074782001 <sup>1)</sup>	7431 ESD	89	1/4"	0,30-1,00	0,05	142	5 7/16"
05074784001 <sup>1)</sup>	7432 ESD	89	1/4"	0,90-1,50	0,05	142	5 7/16"
05074730001	7440 ESD	105	1/4"	0,3-1,2	0,05	155	6"
05074731001	7441 ESD	105	1/4"	1,2-3,0	0,10	155	6"

<sup>1)</sup> With attachable magnifying glass, dramatically improving visibility.



# Rapidaptor

## Rapid-in and self-lock



The bit can be pushed into the adaptor without moving the sleeve. The lock is activated automatically as soon as the bit is applied to the screw. Bits are held securely and wobble-free.

## Rapid-out



Simply push the sleeve forward to change the bit. The spring mechanism lifts the bit off the magnet and unlocks the tool. The bit can be easily removed. The rapid-out function makes it easy to remove even the smallest bits without extra tools.

## Chuck-all



The Rapidaptor quick-release chucks hold 1/4" DIN ISO 1173-C 6,3 and E 6,3 as well as Wera series 1 and 4 bits.

## Single-hand function



Every function of the Rapidaptor quick-release chuck, such as inserting or releasing bits, can be carried out with one hand. This is faster, more economical and more ergonomic. There are no unnecessary manoeuvres.

# Series 7400 Kraftform Torque Screwdrivers

## Variable torque adjustment models

### Series 7400 Kraftform pistol grip, adjustable torque screwdrivers (25.0-55.0 in.lbs.) with Rapidaptor quick-release chuck



- Application:** Suitable for 1/4" DIN ISO 1173-C 6,3 and E 6,3 hexagon insert bits and Wera Series 1 and 4
- Design:** Rapidaptor rapid-in, rapid-out, rapid-spin, chuck-all and single-hand technology
- Accuracy:** ±6 % (DIN EN ISO 6789). Numerical torque value scale. Reliable slipping mechanism and acoustic signal when reaching the set torque.
- Handle:** Kraftform pistol grip, multi-component

	Art.No.						
		in. lbs.	in. lbs.	mm	mm	mm	mm
05074712001	7447	1/4"	25,0-55,0	2,5	150	100	4"

### Series 7400 Kraftform adjustable torque screwdrivers (2.5-29.0 in.lbs.) with Rapidaptor quick-release chuck



- Application:** Suitable for 1/4" DIN ISO 1173-C 6,3 and E 6,3 hexagon insert bits and Wera Series 1 and 4
- Design:** Rapidaptor rapid-in, rapid-out, rapid-spin, chuck-all and single-hand technology
- Accuracy:** ±6 % (DIN EN ISO 6789). Numerical torque value scale. Reliable slipping mechanism and acoustic signal when reaching the set torque.
- Handle:** Kraftform with non-roll feature, multi-component

	Art.No.					
		in. lbs.	in. lbs.	mm	mm	mm
05074710001	7445	1/4"	2,5-11,5	0,5	155	6"
05074711001	7446	1/4"	11,0-29,0	1,0	155	6"

### Series 7400 Kraftform ESD adjustable torque screwdrivers (2.5-29.0 in.lbs.) with Rapidaptor quick-release chuck



- Application:** Suitable for 1/4" DIN ISO 1173-C 6,3 and E 6,3 hexagon insert bits and Wera Series 1 and 4
- Design:** Rapidaptor rapid-in, rapid-out, rapid-spin, chuck-all and single-hand technology, non-magnetic
- Accuracy:** ±6 % (DIN EN ISO 6789). Numerical torque value scale. Reliable slipping mechanism and acoustic signal when reaching the set torque.
- Handle:** Kraftform with non-roll feature, multi-component

	Art.No.					
		in. lbs.	in. lbs.	mm	mm	mm
05074733001	7445 ESD	1/4"	2,5-11,5	0,5	155	6"
05074734001	7446 ESD	1/4"	11,0-29,0	1,0	155	6"



## Series 7400 Kraftform ESD adjustable torque screwdrivers (0.1-1.0 Nm)



**Application:** Suitable for bits with 4 mm Halfmoon drive (and Wera Serie 9) and 4 mm HIOS drive (and Wera Series 21)

**Design:** With quick-release chuck for rapid bit change

**Accuracy:**  $\pm 6\%$  (DIN EN ISO 6789). Numerical torque value scale. Reliable slipping mechanism and acoustic signal when reaching the set torque.

**Handle:** Kraftform with non-roll feature, multi-component

	Art.No.	mm	Nm	Nm	mm	mm
05074786001 <sup>1)</sup>	7435 ESD	89	0,10-0,34	0,015	142	5 7/16"
05074788001 <sup>1)</sup>	7436 ESD	89	0,30-1,00	0,05	142	5 7/16"

<sup>1)</sup> With attachable magnifying glass, dramatically improving visibility.

## 1430 Kraftform Micro ESD adjustable torque screwdrivers (0.02-0.11 Nm) with quick-release chuck



**Application:** Suitable for bits with 4 mm Halfmoon drive (and Wera Serie 9) and 4 mm HIOS drive (and Wera Series 21)

**Design:** With quick-release chuck for rapid bit change

**Accuracy:**  $\pm 10\%$ . Numerical torque value scale. Reliable slipping mechanism and acoustic signal when reaching the set torque.

**Handle:** Kraftform Micro with non-roll feature and rotating cap, multi-component

	Art.No.	Nm	Nm	mm	mm
05074802001 <sup>1)</sup>	1430 ESD	0,02-0,06	0,0025	141	5 7/16"
05074804001 <sup>1)</sup>	1431 ESD	0,05-0,11	0,005	141	5 7/16"

<sup>1)</sup> With attachable magnifying glass, dramatically improving visibility.

## Tip

### Attachable magnifying glass



Articles 7435 ESD, 7436 ESD, 1430 ESD and 1431 ESD, all come with a magnifying glass. This can be easily attached on to the scale, dramatically improving visibility.

### Why does Wera manufacture adjustable Kraftform torque screwdrivers?



Many screws – particularly in assembly and maintenance applications – have to be tightened with controlled torque to ensure the dependability of the screw connection and/or to avoid damage to the screw or work piece. Wera's adjustable torque screwdrivers are the ideal tool for this. They feature a torque range of 0.3 Nm

to 8.8 Nm, two different handles, measurement accuracy of  $\pm 6\%$  and Rapidaptor technology for rapid bit change.

### For Halfmoon and HIOS Bits



The adjustable torque screwdrivers 7435 ESD, 7436 ESD, 1430 ESD and 1431 ESD feature a combination bitholder for both bits with Halfmoon and bits with HIOS drive.

# Series 7400 Kraftform Torque Screwdrivers

## Variable torque adjustment models

### 7440/41 Kraftform torque screwdriver set 0.3-3.0 Nm



05074738001		
●	<b>7400</b>	1 x 7440x1/4"x0,3-1,2; 1 x 7441x1/4"x1,2-3,0
⊕	<b>867/1 TZ TORX®</b>	1 x TX 6x25; 1 x TX 7x25; 1 x TX 8x25; 1 x TX 9x25; 1 x TX 10x25; 1 x TX 15x25; 1 x TX 20x25; 1 x TX 25x25; 1 x TX 30x25
⊕	<b>867/1 Z IP TORX PLUS®</b>	1 x 6 IPx25; 1 x 7 IPx25; 1 x 8 IPx25; 1 x 9 IPx25; 1 x 10 IPx25; 1 x 15 IPx25; 1 x 20 IPx25; 1 x 25 IPx25; 1 x 30 IPx25
○	<b>840/1 Z Hex-Plus</b>	1 x 2,0x25; 1 x 2,5x25; 1 x 3,0x25; 1 x 4,0x25; 1 x 5,0x25; 1 x 6,0x25

### 7440/41/42 Kraftform torque screwdriver set 0.3-6.0 Nm



05074739001		
●	<b>7400</b>	1 x 7440x1/4"x0,3-1,2; 1 x 7441x1/4"x1,2-3,0
●	<b>7400 Pistole</b>	1 x 7442x3,0-6,0
⊕	<b>867/1 TZ TORX®</b>	1 x TX 6x25; 1 x TX 7x25; 1 x TX 8x25; 1 x TX 9x25; 1 x TX 10x25; 1 x TX 15x25; 1 x TX 20x25; 1 x TX 25x25; 1 x TX 30x25
⊕	<b>867/1 Z IP TORX PLUS®</b>	1 x 6 IPx25; 1 x 7 IPx25; 1 x 8 IPx25; 1 x 9 IPx25; 1 x 10 IPx25; 1 x 15 IPx25; 1 x 20 IPx25; 1 x 25 IPx25; 1 x 30 IPx25
○	<b>840/1 Z Hex-Plus</b>	1 x 2,0x25; 1 x 2,5x25; 1 x 3,0x25; 1 x 4,0x25; 1 x 5,0x25; 1 x 6,0x25

### 7445/46/47 Kraftform torque screwdriver set 2.5-55.0 in.lbs.

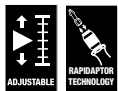

05350451001		
●	<b>7400 inch</b>	1 x 7445x2,5-11,5; 1 x 7446x11,0-29,0
●	<b>7400 Pistole inch</b>	1 x 7447x25,0-55,0
⊕	<b>867/1 TZ TORX®</b>	1 x TX 6x25; 1 x TX 7x25; 1 x TX 8x25; 1 x TX 9x25; 1 x TX 10x25; 1 x TX 15x25; 1 x TX 20x25; 1 x TX 25x25; 1 x TX 30x25
⊕	<b>867/1 Z IP TORX PLUS®</b>	1 x 6 IPx25; 1 x 7 IPx25; 1 x 8 IPx25; 1 x 9 IPx25; 1 x 10 IPx25; 1 x 15 IPx25; 1 x 20 IPx25; 1 x 25 IPx25; 1 x 30 IPx25
○	<b>840/1 Z Hex-Plus</b>	1 x 2,0x25; 1 x 2,5x25; 1 x 3,0x25; 1 x 4,0x25; 1 x 5,0x25; 1 x 6,0x25

### 7443/61/9 Assembly set for tyre pressure control systems

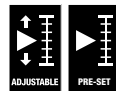

05074745001		
●	<b>7400 vor</b>	1 x 7461x3,3 <sup>1)</sup>
●	<b>7400 Pistole</b>	1 x 7443x4,0-8,8
⊕	<b>300 TX</b>	1 x TX 10x1,4
○	<b>870/1</b>	1 x 1/4"x25
●	<b>790 A/50</b>	1 x 11,0x50,0; 1 x 12,0x50,0
⊕	<b>867/4 TORX® HF</b>	1 x TX 15x50; 1 x TX 20x50
○	<b>327</b>	1 x 32

<sup>1)</sup> Other pre-set values within the adjustable range <3.3 Nm can be delivered on request

## 7443/12 Assembly set for tyre pressure control systems

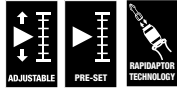

Suitable for all leading system suppliers such as Alligator, Beru, CUB, Herth & Buss, Schrader, VDO/Conti.

1 adjustable torque screwdriver, pistol handle, 4.0-8.8 Nm; 1 pre-set torque screwdriver 3.3 Nm; 1 pre-set torque screwdriver 1.4 Nm TX 10; 1 pre-set torque screwdriver 1.25 Nm TX 10; 1 valve dolly; 1 bit 867/4 HF TX 15 x 50 mm, with holding function for TORX® screws; 1 bit 867/4 HF TX 20 x 50 mm, with holding function for TORX® screws; 1 socket 790 A/50 SW 11.0 x 50 mm; 1 socket 790 A/50 SW 12.0 x 50 mm; 1 adaptor 870/1; 1/4" hexagon to 1/4" square; 1 valve insertion tool, pre-set torque: 0.25 Nm; 1 valve insertion tool, pre-set torque: 0.45 Nm.

Practically arranged in a robust foam insert.

05074746001	
●	7400 Pistole 1 x 7443x4,0-8,8
●	7400 vor 1 x 7461x3,3 <sup>1)</sup>
⊗	300 TX 1 x TX 10x1,25; 1 x TX 10x1,4
●	790 A/50 1 x 11,0x50,0; 1 x 12,0x50,0
⊗	867/4 TORX® 1 x TX 15x50; 1 x TX 20x50
⊗	HF
⊗	870/1 1 x 1/4"x25
●	300 V 1 x 0,25; 1 x 0,45
○	327 1 x 32

<sup>1)</sup> Other pre-set values within the adjustable range < 3.3 Nm can be delivered on request

## Tip

### Assembly sets for tyre control systems



Suitable for all leading system suppliers like Alligator, Beru, CUB, Herth & Buss, Schrader, VDO/Conti.



Including adjustable and pre-set torque tools, colour-coded valve insertion tool and valve dolly. The robust foam insert provides for a practical arrangement system.



# Kraftform Kompakt VDE Torque

Why is the right tool so often missing at the workplace? The reason: too many tools and overly-heavy tool bags can make it bothersome to carry keep them with you.

So for us it was a clear challenge: to develop a tool that is suitable for a whole host of applications and can be easily taken along to the workplace.

Our solution: Kraftform Kompakt tools. A handle into which blades with a range of different profiles can be inserted. Compactly and protectively housed in a light and robust textile pouch – and they are even VDE-tested, too. Variable torque adjustment models.



Kraftform Kompakt VDE sets come with an insulated handle and insulated interchangeable blades, that can be exchanged without any special tools.



The handle/interchangeable blade system allows rapid exchange of the blades required for a wide range of applications.



Each Kraftform Kompakt VDE set has been tested individually at 10,000 volts, in accordance with IEC 60900. This ten-times-higher testing load guarantees safe working at their maximum permitted load of 1,000 volts.



The tools can be stored and carried in a robust belt pouch, keeping them always to hand.



The outstanding design of the Kraftform handle ensures that it fits perfectly into the hand, preventing hand injuries such as blisters and calluses.

All Wera torque screwdrivers manufactured according to DIN EN ISO 6789 are supplied with a Declaration of conformity. Our workshop offers a comprehensive service for all Wera torque tools. Please contact us with any queries regarding service, recalibration or repair on +49 (0)202 40 45 145; Fax: +49 (0)202 40 45 158 or per E-Mail at: [torqueservice@wera.de](mailto:torqueservice@wera.de).

# Kraftform Kompakt VDE Torque

Versatile tools for work on live wiring

## Kraftform Kompakt VDE 15 Torque 1.2-3.0 Nm extra slim 1



1 Series 7400 VDE Kraftform adjustable torque handle (1.2 - 3.0 Nm) for Wera VDE interchangeable blades only

VDE interchangeable blades (each 154 mm long) with reduced blade diameter (articles KK 60 i 0,4x2,5 and KK 67 i TX 10 conventional diameter) with integrated protective insulation, allows sunken screws and spring elements to be accessed and actuated

15-piece set

05059291001	
●	7400 VDE 1 x 7441 VDEx1,2-3,0
+	KK 62 iS 1 x PH 1x154; 1 x PH 2x154
+	KK 65 iS PZ 1 x PZ 1x154; 1 x PZ 2x154
+	KK 65 iS PZ/S 1 x # 1x154; 1 x # 2x154
+	KK 67 i TORX® 1 x TX 10x154
+	KK 67 iS 1 x TX 15x154; 1 x TX 20x154; 1 x TX 25x154 TORX®
●	KK 60 i 1 x 0,4x2,5x154
●	KK 60 iS 1 x 0,6x3,5x154; 1 x 0,8x4,0x154; 1 x 1,0x5,5x154

## Kraftform Kompakt VDE 16 Torque 1.2-3.0 Nm extra slim 1



1 Series 7400 VDE Kraftform adjustable torque handle (1.2 - 3.0 Nm) and 1 Kraftform handle 817 VDE for Wera VDE interchangeable blades only

VDE interchangeable blades (each 154 mm long) with reduced blade diameter (articles KK 60 i 0,4x2,5 and KK 67 i TX 10 conventional diameter) with integrated protective insulation, allows sunken screws and spring elements to be accessed and actuated

16-piece set

05135906001	
●	7400 VDE 1 x 7441 VDE, 1,2-3,0 Nm
●	817 VDE 1 x 9x102
+	KK 62 iS 1 x PH 1x154; 1 x PH 2x154
+	KK 65 iS PZ 1 x PZ 1x154; 1 x PZ 2x154
+	KK 65 iS PZ/S 1 x # 1x154; 1 x # 2x154
+	KK 67 i TORX® 1 x TX 10x154
+	KK 67 iS 1 x TX 15x154; 1 x TX 20x154; 1 x TX 25x154 TORX®
●	KK 60 i 1 x 0,4x2,5x154
●	KK 60 iS 1 x 0,6x3,5x154; 1 x 0,8x4,0x154; 1 x 1,0x5,5x154

**Series 7400 VDE Kraftform adjustable torque handle (0.3-3.5 Nm)**



**Application:** For Wera interchangeable Kraftform Kompakt VDE blades only  
**Accuracy:** ±6 % (DIN EN ISO 6789). Numerical torque value scale. Reliable slipping mechanism and acoustic signal when reaching the set torque.  
**Handle:** Kraftform with non-roll feature, multi-component

		mm	Nm	Nm	Nm	mm
05074752001	7440 VDE	9	0,3-1,2	0,05	192	7 9/16"
05074750001	7441 VDE	9	1,2-3,0	0,10	192	7 9/16"
05074757001	7444 VDE	9	1,7-3,5	0,10	192	7 9/16"

**Kraftform Kompakt VDE 60 i**



**Application:** Slotted screws  
**Blade:** Insulated, individually tested as per IEC 60900  
**Drive:** 9 mm hexagonal with entry chamfer  
**Design:** Conical blade, zinc-phosphated, Black Point

	mm	mm	mm	mm	mm
05003400001	0,4	2,5	154	3/32"	6 1/16"
05003401001	0,5	3,0	154	1/8"	6 1/16"
05003402001	0,6	3,5	154	9/64"	6 1/16"
05003403001	0,8	4,0	154	5/32"	6 1/16"
05003404001	1,0	5,5	154	7/32"	6 1/16"
05003405001	1,2	6,5	154	1/4"	6 1/16"

**Tip**



**Kraftform VDE adjustable torque handle**



Simple setting of the required torque by hand.

Easy-to-read scale value. Measurement accuracy is ± 6 % in accordance with the standard EN ISO 6789.

Distinctly audible and noticeable excess-load signal when the pre-set torque is reached.



# Kraftform Kompakt VDE Torque

## Versatile tools for work on live wiring

### Kraftform Kompakt VDE 60 iS



**Application:** Slotted screws

**Blade:** Reduced blade diameter with integrated protective insulation, allows sunken screws and spring elements to be accessed and actuated, individually tested as per IEC 60900

**Drive:** 9 mm hexagonal with entry chamfer

**Design:** Conical blade, zinc-phosphated, Black Point

	mm	mm	mm	"	"
05003406001	0,6	3,5	154	$\frac{9}{64}$	$6 \frac{1}{16}$
05003407001	0,8	4,0	154	$\frac{5}{32}$	$6 \frac{1}{16}$
05003408001	1,0	5,5	154	$\frac{7}{32}$	$6 \frac{1}{16}$

### Kraftform Kompakt VDE 62 iS



**Application:** Phillips screws

**Blade:** Reduced blade diameter with integrated protective insulation, allows sunken PH screws to be accessed and actuated, individually tested as per IEC 60900

**Drive:** 9 mm hexagonal with entry chamfer

**Design:** Zinc-phosphated, Black Point

	+	mm	"
05003413001	PH 1	154	$6 \frac{1}{16}$
05003414001	PH 2	154	$6 \frac{1}{16}$

### Kraftform Kompakt VDE 62 i



**Application:** Phillips screws

**Blade:** Insulated, individually tested as per IEC 60900

**Drive:** 9 mm hexagonal with entry chamfer

**Design:** Zinc-phosphated, Black Point

	+	mm	"
05003410001	PH 0	154	$6 \frac{1}{16}$
05003411001	PH 1	154	$6 \frac{1}{16}$
05003412001	PH 2	154	$6 \frac{1}{16}$

### Kraftform Kompakt VDE 65 i



**Application:** Pozidriv screws

**Blade:** Insulated, individually tested as per IEC 60900

**Drive:** 9 mm hexagonal with entry chamfer

**Design:** Zinc-phosphated, Black Point

	*	mm	"
05003450001	PZ 0	154	$6 \frac{1}{16}$
05003451001	PZ 1	154	$6 \frac{1}{16}$
05003452001	PZ 2	154	$6 \frac{1}{16}$

### Kraftform Kompakt VDE 65 iS



**Application:** Pozidriv screws

**Blade:** Reduced blade diameter with integrated protective insulation, allows sunken PZ screws to be accessed and actuated, individually tested as per IEC 60900

**Drive:** 9 mm hexagonal with entry chamfer

**Design:** Zinc-phosphated, Black Point



	*	mm	"
05003455001	PZ 1	154	$6 \frac{1}{16}$
05003456001	PZ 2	154	$6 \frac{1}{16}$



### Kraftform Kompakt VDE 62 i PH/S





- Application:** PlusMinus screws, slotted/Phillips  
**Blade:** Insulated, individually tested as per IEC 60900  
**Drive:** 9 mm hexagonal with entry chamfer  
**Design:** PlusMinus, slotted/Phillips, zinc-phosphated, Black Point

			
		mm	
05003440001	# 1	154	6 1/16"
05003441001	# 2	154	6 1/16"

### Kraftform Kompakt VDE 62 iS PH/S





- Application:** PlusMinus screws, slotted/Phillips  
**Blade:** Reduced blade diameter with integrated protective insulation, allows sunken PlusMinus screws to be accessed and actuated, individually tested as per IEC 60900  
**Drive:** 9 mm hexagonal with entry chamfer  
**Design:** PlusMinus, slotted/Phillips, zinc-phosphated, Black Point

			
		mm	
05003442001	# 1	154	6 1/16"
05003443001	# 2	154	6 1/16"

### Kraftform Kompakt VDE 65 i PZ/S





- Application:** PlusMinus screws, slotted/Pozidriv  
**Blade:** Insulated, individually tested as per IEC 60900  
**Drive:** 9 mm hexagonal with entry chamfer  
**Design:** PlusMinus, slotted/Pozidriv, zinc-phosphated, Black Point

			
		mm	
05003445001	# 1	154	6 1/16"
05003446001	# 2	154	6 1/16"

### Kraftform Kompakt VDE 65 iS PZ/S





- Application:** PlusMinus screws, slotted/Pozidriv  
**Blade:** Reduced blade diameter with integrated protective insulation, allows sunken PlusMinus screws to be accessed and actuated, individually tested as per IEC 60900  
**Drive:** 9 mm hexagonal with entry chamfer  
**Design:** PlusMinus, slotted/Pozidriv, zinc-phosphated, Black Point

			
		mm	
05003447001	# 1	154	6 1/16"
05003448001	# 2	154	6 1/16"

### Kraftform Kompakt VDE 67 i TORX®



- Application:** TORX® socket screws  
**Blade:** Insulated, individually tested as per IEC 60900  
**Drive:** 9 mm hexagonal with entry chamfer  
**Design:** Zinc-phosphated, Black Point

			
		mm	
05003429001	TX 8	154	6 1/16"
05003430001	TX 9	154	6 1/16"
05003431001	TX 10	154	6 1/16"
05003432001	TX 15	154	6 1/16"
05003433001	TX 20	154	6 1/16"
05003434001	TX 25	154	6 1/16"
05003435001	TX 27	154	6 1/16"
05003436001	TX 30	154	6 1/16"

# Kraftform Kompakt VDE Torque

Versatile tools for work on live wiring

## Kraftform Kompakt VDE 67 iS TORX®





**Application:** TORX® socket screws

**Blade:** Reduced blade diameter with integrated protective insulation, allows sunken TORX® socket screws to be accessed and actuated, individually tested as per IEC 60900

**Drive:** 9 mm hexagonal with entry chamfer

**Design:** Zinc-phosphated, Black Point

		 mm	 "
05003437001	TX 15	154	6 1/16"
05003438001	TX 20	154	6 1/16"
05003439001	TX 25	154	6 1/16"

## Kraftform Kompakt VDE 68 iS





**Application:** Square socket head screws

**Blade:** Reduced blade diameter with integrated protective insulation, allows sunken square socket head screws to be accessed and actuated, individually tested as per IEC 60900

**Drive:** 9 mm hexagonal with entry chamfer

**Design:** Zinc-phosphated, Black Point

		 mm	 "
05003417001	# 1	154	6 1/16"
05003418001	# 2	154	6 1/16"

## Kraftform Kompakt VDE 68 i





**Application:** Square socket head screws

**Blade:** Insulated, individually tested as per IEC 60900

**Drive:** 9 mm hexagonal with entry chamfer

**Design:** Zinc-phosphated, Black Point

		 mm	 "
05003415001	# 1	154	6 1/16"
05003416001	# 2	154	6 1/16"

## Kraftform Kompakt VDE 64 i





**Application:** Hexagon socket screws

**Blade:** Insulated, individually tested as per IEC 60900

**Drive:** 9 mm hexagonal with entry chamfer

**Design:** Zinc-phosphated, Black Point

	 mm	 mm	 "
05003420001	2,5	154	6 1/16"
05003421001	3,0	154	6 1/16"
05003422001	4,0	154	6 1/16"
05003423001	5,0	154	6 1/16"
05003424001	6,0	154	6 1/16"

### Kraftform Kompakt 96 VK 6,3



Switch cabinet key, 6.3 mm, glass-fibre reinforced

	mm	mm	
05003460001	6,3	89	3 <sup>9</sup> / <sub>16</sub> "

### Kraftform Kompakt 99 FL



Switch cabinet key, glass-fibre reinforced

		mm	
05003463001		89	3 <sup>9</sup> / <sub>16</sub> "

### Kraftform Kompakt 97 VK 8,1



Switch cabinet key, 8.1 mm, glass-fibre reinforced

	mm	mm	
05003461001	8,1	89	3 <sup>9</sup> / <sub>16</sub> "

### Kraftform Kompakt 98 DK



Switch cabinet key, glass-fibre reinforced

		mm	
05003462001		89	3 <sup>9</sup> / <sub>16</sub> "

# Pre-set, adjustable Torque Screwdrivers

These tools are ideal for all applications where a constant, identical torque is required and where a high degree of repeat accuracy is needed. The torque value can be adjusted within the measuring range.



Unlimited torque for loosening seized screws.



Distinctly audible and noticeable excess-load signal when the pre-set torque is reached.



Rapidaptor technology makes the tool adaptable since bits and sockets can be exchanged rapidly.



Multi-component Kraftform handle with hard and soft zones for fast working speeds and protecting the palm of the hand.

# Series 7400 Kraftform Torque Screwdrivers

## Pre-set, adjustable torque models

**Serie 7400 Kraftform pre-set adjustable torque screwdrivers (0.1-3.0 Nm) with Rapidaptor quick-release chuck**



**Application:** Suitable for 1/4" DIN ISO 1173-C 6,3 and E 6,3 hexagon insert bits and Wera Series 1 and 4

**Design:** Rapidaptor rapid-in, rapid-out, rapid-spin, chuck-all and single-hand technology

**Pre-set torque:** 0.1 Nm, 0.3 Nm, 0.9 Nm, 1.2 Nm

**Accuracy:** ± 6% (DIN EN ISO 6789). Reliable slipping mechanism and acoustic signal when reaching the set torque.

**Handle:** Kraftform with non-roll feature, multi-component

	Art.No.	mm	mm	Nm	Nm	mm	mm
05074790001	7450	89	1/4"	0,1	0,1-0,34	133	5 1/4"
05074790010 <sup>1)</sup>	7450	89	1/4"	0,1	0,1-0,34	133	5 1/4"
05074792001	7451	89	1/4"	0,3	0,3-1,0	133	5 1/4"
05074792010 <sup>1)</sup>	7451	89	1/4"	0,3	0,3-1,0	133	5 1/4"
05074794001	7452	89	1/4"	0,9	0,9-1,5	133	5 1/4"
05074794010 <sup>1)</sup>	7452	89	1/4"	0,9	0,9-1,5	133	5 1/4"
05074715001	7460	105	1/4"	0,3	0,3-1,2	155	6"
05074715010 <sup>1)</sup>	7460	105	1/4"	0,3	0,3-1,2	155	6"
05074716001	7461	105	1/4"	1,2	1,2-3,0	155	6"
05074716010 <sup>1)</sup>	7461	105	1/4"	1,2	1,2-3,0	155	6"

<sup>1)</sup> Other pre-set values within the adjustable range can be delivered on request

**Series 7400 Kraftform pistol grip, pre-set adjustable torque screwdrivers (3.0-8.8 Nm) with Rapidaptor quick-release chuck**



**Application:** Suitable for 1/4" DIN ISO 1173-C 6,3 and E 6,3 hexagon insert bits and Wera Series 1 and 4

**Design:** Rapidaptor rapid-in, rapid-out, rapid-spin, chuck-all and single-hand technology

**Pre-set torque:** 3.0 Nm, 4.0 Nm

**Accuracy:** ± 6% (DIN EN ISO 6789). Reliable slipping mechanism and acoustic signal when reaching the set torque.

**Handle:** Kraftform pistol grip, multi-component

	Art.No.	mm	Nm	Nm	mm	mm
05074717001	7462	1/4"	3,0	3,0-6,0	150	100 6" 4"
05074717010 <sup>1)</sup>	7462	1/4"	3,0	3,0-6,0	150	100 6" 4"
05074728001	7463	1/4"	4,0	4,0-8,8	150	100 6" 4"
05074728010 <sup>1)</sup>	7463	1/4"	4,0	4,0-8,8	150	100 6" 4"

<sup>1)</sup> Other pre-set values within the adjustable range can be delivered on request

**Serie 7400 Kraftform ESD pre-set adjustable torque screwdrivers (0.1-1.2 Nm) with Rapidaptor quick-release chuck**



- Application:** Suitable for 1/4" DIN ISO 1173-C 6,3 and E 6,3 hexagon insert bits and Wera Series 1 and 4
- Design:** Rapidaptor rapid-in, rapid-out, rapid-spin, chuck-all and single-hand technology
- Pre-set torque:** 0.1 Nm, 0.3 Nm, 0.9 Nm, 1.2 Nm
- Accuracy:** ± 6% (DIN EN ISO 6789). Reliable slipping mechanism and acoustic signal when reaching the set torque.
- Handle:** Kraftform with non-roll feature, multi-component

	Art.No.	mm	Nm	Nm	mm	mm
	05074820001	7450 ESD 89	1/4" 0,1	0,1-0,34	133	5 1/4"
	05074820010 <sup>1)</sup>	7450 ESD 89	1/4" 0,1	0,1-0,34	133	5 1/4"
	05074822001	7451 ESD 89	1/4" 0,3	0,3-1,0	133	5 1/4"
	05074822010 <sup>1)</sup>	7451 ESD 89	1/4" 0,3	0,3-1,0	133	5 1/4"
	05074824001	7452 ESD 89	1/4" 0,9	0,9-1,5	133	5 1/4"
	05074824010 <sup>1)</sup>	7452 ESD 89	1/4" 0,9	0,9-1,5	133	5 1/4"
	05074840001	7460 ESD 105	1/4" 0,3	0,3-1,2	155	6"
	05074840010 <sup>1)</sup>	7460 ESD 105	1/4" 0,3	0,3-1,2	155	6"
	05074842001	7461 ESD 105	1/4" 1,2	1,2-3,0	155	6"
	05074842010 <sup>1)</sup>	7461 ESD 105	1/4" 1,2	1,2-3,0	155	6"

<sup>1)</sup> Other pre-set values within the adjustable range can be delivered on request

# Tip

## Why does Wera manufacture pre-set, adjustable Kraftform torque screwdrivers?



These torque screwdrivers are supplied with a fixed pre-set torque value. This is ideal for all applications that require constant, identical torque. They feature a pre-set torque range of 0.3 Nm to 4.0 Nm (adjustable between 0.3 Nm – 8.8 Nm), two different handles, measurement accuracy of ± 6 % and Rapidaptor chuck technology for rapid bit change.

## Customized pre-setting



The pre-set torque screwdrivers 7400, 1460, 1461 with a pre-set torque value can be set to any value within the specified metered range in the test laboratory.





# Series 7400 Kraftform Torque Screwdrivers

## Pre-set, adjustable torque models

**Series 7400 Kraftform pre-set adjustable torque screwdrivers (2.5-29.0 in. lbs.) with Rapidaptor quick-release chuck**



- Application:** Suitable for 1/4" DIN ISO 1173-C 6,3 and E 6,3 hexagon insert bits and Wera Series 1 and 4
- Design:** Rapidaptor rapid-in, rapid-out, rapid-spin, chuck-all and single-hand technology
- Pre-set torque:** 2.5 in.lbs., 11.0 in.lbs.
- Accuracy:** ±6 % (DIN EN ISO 6789). Reliable slipping mechanism and acoustic signal when reaching the set torque.
- Handle:** Kraftform with non-roll feature, multi-component







	Art.No.					
		in. lbs.	in. lbs.	mm		
05074720001	7465	1/4"	2,5	2,5-11,5	155	6"
05074720010 <sup>1)</sup>	7465	1/4"	2,5	2,5-11,5	155	6"
05074722001	7466	1/4"	11,0	11,0-29,0	155	6"
05074722010 <sup>1)</sup>	7466	1/4"	11,0	11,0-29,0	155	6"

<sup>1)</sup> Other pre-set values within the adjustable range can be delivered on request

**Series 7400 Kraftform pistol grip, pre-set adjustable torque screwdriver (25.0-55.0 in. lbs.) with Rapidaptor quick-release chuck**



- Application:** Suitable for 1/4" DIN ISO 1173-C 6,3 and E 6,3 hexagon insert bits and Wera Series 1 and 4
- Design:** Rapidaptor rapid-in, rapid-out, rapid-spin, chuck-all and single-hand technology
- Pre-set torque:** 25.0 in. lbs.
- Accuracy:** ±6 % (DIN EN ISO 6789). Reliable slipping mechanism and acoustic signal when reaching the set torque.
- Handle:** Kraftform pistol grip, multi-component

	Art.No.							
		in. lbs.	in. lbs.	mm	mm			
05074721001	7467	1/4"	25,0	25,0-55,0	150	100	6"	4"
05074721010 <sup>1)</sup>	7467	1/4"	25,0	25,0-55,0	150	100	6"	4"

<sup>1)</sup> Other pre-set values within the adjustable range can be delivered on request



## Serie 7400 Kraftform pre-set adjustable torque screwdrivers (0.1-1.0 Nm) with quick-release chuck



- Application:** Suitable for bits with 4 mm Halfmoon drive (and Wera Serie 9) and 4 mm HIOS drive (and Wera Series 21)
- Design:** With quick-release chuck for rapid bit change
- Pre-set torque:** 0.1 Nm, 0.3 Nm
- Accuracy:** ± 6% (DIN EN ISO 6789). Reliable slipping mechanism and acoustic signal when reaching the set torque.
- Handle:** Kraftform with non-roll feature, multi-component

	Art.No.	mm	Nm	Nm	mm	mm
05074826001	7455 ESD	89	0,015	0,1-0,34	138	5 1/4"
05074826010 <sup>1)</sup>	7455 ESD	89	0,015	0,1-0,34	138	5 1/4"
05074828001	7456 ESD	89	0,035	0,3-1,0	138	5 1/4"
05074828010 <sup>1)</sup>	7456 ESD	89	0,035	0,3-1,0	138	5 1/4"

<sup>1)</sup> Other pre-set values within the adjustable range can be delivered on request

## 1460 Kraftform Micro ESD pre-set adjustable torque screwdrivers (0.02-0.11 Nm) with quick-release chuck



- Application:** Suitable for bits with 4 mm Halfmoon drive (and Wera Serie 9) and 4 mm HIOS drive (and Wera Series 21)
- Design:** With quick-release chuck for rapid bit change
- Pre-set torque:** 0.035 Nm, 0.05 Nm
- Accuracy:** ± 10%. Reliable slipping mechanism and acoustic signal when reaching the set torque.
- Handle:** Kraftform Micro with non-roll feature and rotating cap, multi-component

	Art.No.	Nm	Nm	mm	mm
05074800001	1460 ESD	0,035	0,02-0,06	131	5 1/4"
05074800010 <sup>1)</sup>	1460 ESD	0,035	0,02-0,06	131	5 1/4"
05074810001	1461 ESD	0,050	0,05-0,11	131	5 1/4"
05074810010 <sup>1)</sup>	1461 ESD	0,050	0,05-0,11	131	5 1/4"

<sup>1)</sup> Other pre-set values within the adjustable range can be delivered on request

## Tip



### ESD-safe tools



The requirements for ESD-safe screwdrivers are specified in the European standard DIN EN 61340-5-1. This standard also includes a handle that has to be out of a defined conductive material. The Wera products in the ESD series satisfy these standards and the even more stringent requirements demanded by some technology companies.

## For Halfmoon and HIOS Bits



The adjustable torque screwdrivers 7455 ESD, 7456 ESD, 1460 ESD and 1461 ESD feature a combination bitholder for both bits with Halfmoon and bits with HIOS drive.

## Customized pre-setting



The pre-set torque screwdrivers 7400, 1460, 1461 with a pre-set torque value can be set to any value within the specified metered range in the test laboratory.

# Torque-indicators

Wera torque-indicators have been factory pre-set to values recommended by leading carbide tool manufacturers. These tightening values relate specifically to the size of the TORX®, TORX PLUS® or hexagon socket screw. Torque indicators ensure safe and easy loosening of screw connections. Precision : ± 10 %



Torque blade assembly precisely adjusted to the respective screw size for the TORX®, TORX PLUS® and hexagon socket screw profiles.



Non-adjustable and tamperproof.



Distinctly audible and noticeable excess-load signal when the pre-set torque is reached.

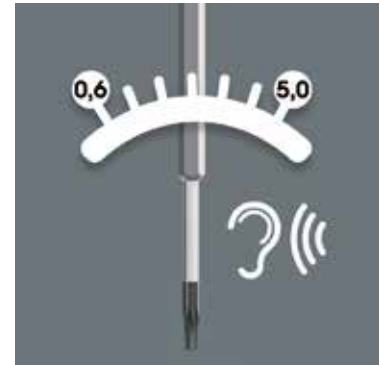

Slim 4 mm hexagon blades to reach screws in difficult-to-access places.



Unlimited torque for loosening seized screws.



Multi-component Kraftform handle with hard and soft zones for fast working speeds and protecting the palm of the hand.



# Series

## Torque-indicators

### Pre-set torque models

#### 300 Hex torque-indicator



- Application:** Hexagon socket screws
- Pre-set torque:** 1.4 Nm-3.0 Nm (1.0 ft.lb.-2.2 ft.lb.), fixed pre-sets
- Accuracy:** ± 10%. Reliable slipping mechanism and acoustic signal when reaching the set torque.
- Blade:** Hexagonal, 4 mm, reduced diameter tip
- Design:** Hex-Plus, Black Point
- Handle:** Kraftform with non-roll feature, multi-component

	○	Nm	ft. lb.	mm	mm	mm	mm	mm
05027910001	○	2,0	1,4	1,0	4	3,5	65	105
05027911001	○	2,5	2,0	1,5	4	3,8	65	105
05027912001	○	3,0	3,0	2,2	4	3,8	65	105

#### 300 Hex torque-indicator, pistol grip



- Application:** Hexagon socket screws
- Pre-set torque:** 5.0 Nm (3.7 ft. lb.), fixed pre-set
- Accuracy:** ± 10%. Reliable slipping mechanism and acoustic signal when reaching the set torque.
- Blade:** Hexagonal, 8 mm, reduced diameter tip
- Design:** Hex-Plus, Black Point
- Handle:** Kraftform pistol grip, multi-component

	○	mm	mm	mm	mm	mm	mm
05027913001	○	4,0	160	100	65	2 9/16"	25

#### 300 IP TORX PLUS® torque-indicator



- Application:** TORX PLUS® socket screws
- Pre-set torque:** 0.6 Nm-3.0 Nm (0.4 ft.lb.-3.0 ft.lb.), fixed pre-sets
- Accuracy:** ± 10%. Reliable slipping mechanism and acoustic signal when reaching the set torque.
- Blade:** Hexagonal, 4 mm, reduced diameter tip
- Design:** Black Point
- Handle:** Kraftform with non-roll feature, multi-component

	⊛	Nm	ft. lb.	mm	mm	mm	mm	mm
05028040001	⊛	6 IP	0,6	0,4	4	3,5	65	105
05028041001	⊛	7 IP	0,9	0,7	4	3,5	65	105
05028042001	⊛	8 IP	1,2	0,9	4	3,5	65	105
05028043001	⊛	9 IP	1,4	1,0	4	3,5	65	105
05028044001	⊛	10 IP	2,0	1,5	4	3,8	65	105
05028045001	⊛	15 IP	3,0	2,2	4	3,8	65	105

#### 300 TX TORX® torque-indicator



- Application:** TORX® socket screws
- Pre-set torque:** 0.6 Nm-3.0 Nm (0.4 ft.lb.-2.2 ft.lb.), fixed pre-sets
- Accuracy:** ± 10%. Reliable slipping mechanism and acoustic signal when reaching the set torque.
- Blade:** Hexagonal, 4 mm, reduced diameter tip
- Design:** Black Point
- Handle:** Kraftform with non-roll feature, multi-component

	⊛	Nm	ft. lb.	mm	mm	mm	mm	mm
05027930001	⊛	TX 6	0,6	0,4	4	3,5	65	105
05027931001	⊛	TX 7	0,9	0,7	4	3,5	65	105
05027932001	⊛	TX 8	1,2	0,9	4	3,5	65	105
05027933001	⊛	TX 9	1,4	1,0	4	3,5	65	105
05027934001	⊛	TX 10	2,0	1,5	4	3,8	65	105
05027935001	⊛	TX 15	3,0	2,2	4	3,8	65	105

### 300 IP TORX PLUS® torque-indicator, pistol grip



- Application:** TORX PLUS® socket screws
- Pre-set torque:** 5.0 Nm (3.7 ft. lb.), fixed pre-set
- Accuracy:** ± 10%. Reliable slipping mechanism and acoustic signal when reaching the set torque.
- Blade:** Hexagonal, 8 mm, reduced diameter tip
- Design:** Black Point
- Handle:** Kraffform pistol grip, multi-component

		mm	mm	mm	mm	mm	mm
05028046001	20 IP	160	100	65	2 9/16"	25	1"

### 300 TX TORX® torque-indicator, pistol grip



- Application:** TORX® socket screws
- Pre-set torque:** 5.0 Nm (3.7 ft. lb.), fixed pre-set
- Accuracy:** ± 10%. Reliable slipping mechanism and acoustic signal when reaching the set torque.
- Blade:** Hexagonal, 8 mm, reduced diameter tip
- Design:** Black Point
- Handle:** Kraffform pistol grip, multi-component

		mm	mm	mm	mm	mm	mm
05027936001	TX 20	160	100	65	2 9/16"	25	1"

## Tip

### Less is often more

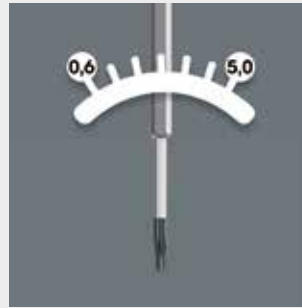

unlimited loosening torque, two handles, tamper-proof.

Some screw connections require specific torque values so that they can be tightened or loosened easily. Wera torque-indicators are pre-set to torque values recommended by leading carbide tool manufacturers. Pre-set torque between 0.6 Nm and 5.0 Nm, for TORX®, TORX PLUS® and hexagon socket screws,

### Tamperproof



Non-adjustable and tamper-proof.

# Series

## Torque-indicators

### Pre-set torque models

#### 400 Hex Torque-indicator



**Application:** Hexagon socket screws

**Pre-set torque:** 4,0 Nm, 5,0 Nm; fixed pre-set

**Accuracy:** ±10 %. Reliable slipping mechanism and acoustic signal when reaching the set torque.

**Blade:** Round

**Design:** Hex-Plus, brushed chrome-plated finish, Black Point

**Handle:** T-handle, multi-component

		Nm	mm	mm	mm	mm	mm	
05005080001		4,0	4,0	60	48	100	2 3/8"	7,0
05005081001		5,0	5,0	60	48	100	2 3/8"	7,0

#### 400 TX Torque-indicator



**Application:** TORX® socket screws

**Pre-set torque:** 4,0 Nm, 5,0 Nm; fixed pre-set

**Accuracy:** ±10 %. Reliable slipping mechanism and acoustic signal when reaching the set torque.

**Blade:** Round

**Design:** Brushed chrome-plated finish, Black Point

**Handle:** T-handle, multi-component

		Nm	mm	mm	mm	mm	mm
05005090001	TX 20	4,0	60	48	100	2 3/8"	7,0
05005091001	TX 25	5,0	60	48	100	2 3/8"	7,0

## 400 i VDE Hex Insulated torque-indicator



**Application:** Hexagon socket screws

**Pre-set torque:** 5.0 Nm, fixed pre-set

**Accuracy:** ±10 %. Reliable slipping mechanism and acoustic signal when reaching the set torque.

**Blade:** Insulated, individually tested as per IEC 60900

**Design:** Hex-Plus, Black Point

**Handle:** T-handle, multi-component

	⊙	Nm	mm	mm	mm	mm	mm
05004980001	4,0	5,0	90	48	100	3 1/2"	8,0
05004981001	5,0	5,0	90	48	100	3 1/2"	8,0

## Tip

### Torque-indicators



Suitable for applications requiring a non-adjustable i.e. a tamperproof torque blade assembly.

### T-handle



The ergonomic design of the T-handle fills the palm of the hand. The fingers rest in the soft, rounded recess, and the whole hand is in contact with the handle – so there is no friction loss between the hand and handle.

### The important information is indicated on the tool



The handle is marked with an indicative screw symbol, size, torque and maximum release torque.

### Excess-load signal



Distinctly audible and noticeable excess-load signal when the pre-set torque is reached.

# Click-Torque Wrench Series

We wanted working with torque wrenches to be simple and accurate – which is why we developed the Click-Torque wrenches.

With the ability to set and save the default values and with the unmistakable, robust Wera design, these torque wrenches are the ideal tools for all bolting applications that require torque-controlled tightening (clockwise torque wrenches) and tightening and loosening (torque wrenches for insert tools).



Precise to  $\pm 2\%$ ,  $\pm 3\%$  or  $\pm 4\%$  as per DIN EN ISO 6789-1:2017-07.



Easy setting and saving of the desired torque value; readable on the main and fine scales.



With audible and tactile clicks when adjusting the scale values.



When the set torque value is reached, an audible and tactile mechanism triggers.



Very robust design with reversible ratchet (45 teeth) or for insert tools (9x12 mm or 14x18 mm) and ergonomic 2-component handle.



The reversible Click-Torque wrenches are for right-handed use, the Click-Torque wrenches for insert tools are suitable for right-hand and left-hand uses.





The Click-Torque wrenches are available for clockwise torque-controlled tightening with a reversible ratchet ( $\frac{1}{4}$ ",  $\frac{3}{8}$ ",  $\frac{1}{2}$ " and  $\frac{3}{4}$ " drive) or for insert tools (9x12 mm, 14x18 mm) for torque ranges from 2.5 Nm to 1000 Nm.

All Wera Click-Torque wrenches manufactured according to DIN EN ISO 6789 are supplied with a Declaration of conformity. Our workshop offers a comprehensive service for all Wera torque tools. Please contact us with any queries regarding service, recalibration or repair on +49 (0)202 40 45 145; Fax: +49 (0)202 40 45 158 or per E-Mail at: [torqueservice@wera.de](mailto:torqueservice@wera.de).

# Series Click-Torque Wrenches

## with reversible ratchet

### Click-Torque A 5 torque wrench with reversible ratchet



**Application:** For clockwise torque-control

**Precision:** ± 4% of set value, as per DIN EN ISO 6789-1: 2017-07

**Design:** With 1/4" square drive, reversible ratchet, 45 teeth; easy setting and saving of the desired torque value, with audible and tactile locking when the scale values are reached (fine scale only in Newton meters), audible and tactile release mechanism when the set torque value is reached

**Handle:** Ergonomic 2-component handle

	Nm	Nm	lbf. ft.	mm	mm	mm	mm	mm	mm	mm	mm	mm	mm	mm
05075604001	1/4"	2,5-25	0,10	1-18	290	121	42	25	11,5	11 27/64"	4 49/64"	1 21/32"	1"	7/16"

### Click-Torque A 6 torque wrench with reversible ratchet



**Application:** For clockwise torque-control

**Precision:** ± 4% of set value, as per DIN EN ISO 6789-1: 2017-07

**Design:** With 1/4" hex drive, reversible ratchet, 45 teeth; easy setting and saving of the desired torque value, with audible and tactile locking when the scale values are reached (fine scale only in Newton meters), audible and tactile release mechanism when the set torque value is reached

**Handle:** Ergonomic 2-component handle

	Nm	Nm	lbf. ft.	mm	mm	mm	mm	mm	mm	mm	mm	mm	mm	mm
05075605001	1/4"	2,5-25	0,10	1-18	290	121	42	25	11,5	11 27/64"	4 49/64"	1 21/32"	1"	7/16"



# Series

## Click-Torque Wrenches

### with reversible ratchet

#### Click-Torque A 6 Set 1



20 piece-set; in a surface protecting, compact and extremely robust textile box; low volume and weight for simplified mobility.

1 Click-Torque A 6 torque wrench with 1/4" hexagon drive, covering a range of 2.5 Nm-25 Nm, accuracy ± 4% of the set value, as per DIN EN ISO 6789-1: 2017-07, for clockwise torque control, reversible ratchet, 45 teeth, easy setting and saving of the desired torque value, with audible and tactile locking when the scale values are reached (fine scale only in Newton meters), audible and tactile release mechanism when the set torque value is reached, ergonomic 2-component handle, 6 Zyklop sockets, 1 adapter 1/4" hexagon to 1/4" square, 11 bits, 1 Zyklop extension with free-turning sleeve, short

05130110001	
	<b>Click-Torque A 6</b> 1 x 1/4", 2,5-25 Nm
+	<b>851/4 TZ PH</b> 1 x PH 2x50
+	<b>867/4 Z TORX®</b> 1 x TX 15x50; 1 x TX 20x50; 1 x TX 25x50; 1 x TX 27x50; 1 x TX 30x50; 1 x TX 40x50
○	<b>840/4 Z Hex-Plus</b> 1 x 3,0x50; 1 x 4,0x50; 1 x 5,0x50; 1 x 6,0x50
○	<b>870/1</b> 1 x 1/4"x25 <sup>1)</sup>
○	<b>8794 A</b> 1 x 1/4"x75,0
○	<b>8790 HMA</b> 1 x 6,0x23,0; 1 x 7,0x23,0; 1 x 8,0x23,0; 1 x 10,0x23,0; 1 x 12,0x23,0; 1 x 13,0x23,0
	<b>K240</b> 1 x 50,0x240,0

<sup>1)</sup> With friction ball; for manual nut spinner sockets

#### Click-Torque C 3 Set 1



13 piece-set; in a surface protecting, compact and extremely robust textile box; low volume and weight for simplified mobility.

1 Click-Torque torque wrench C 3 with 1/2" square drive, covering a range of 40 Nm-200 Nm, accuracy ± 3% of the set value, as per DIN EN ISO 6789-1: 2017-07, for clockwise torque control, reversible ratchet, 45 teeth, easy setting and saving of the desired torque value, with audible and tactile locking when the scale values are reached (fine scale only in Newton meters), audible and tactile release mechanism when the set torque value is reached, ergonomic 2-component handle, 4 Zyklop sockets, 4 Zyklop bit sockets with holding function for TORX® screws made according to Acument Intellectual Properties specifications, 3 Zyklop bit sockets with holding function for hexagon socket screws, 1 Zyklop extension with free-turning sleeve, short

05075680001	
	<b>Click-Torque C 3</b> 1 x 1/2", 40-200 Nm
●	<b>8790 HMC</b> 1 x 10,0x37,0; 1 x 13,0x37,0; 1 x 17,0x37,0; 1 x 19,0x37,0
+	<b>8767 C HF</b> 1 x TX 30x60,0; 1 x TX 40x60,0; 1 x TX 45x60,0; 1 x TX 50x60,0
○	<b>8740 C HF</b> 1 x 6,0x60,0; 1 x 8,0x60,0; 1 x 10,0x60,0
○	<b>8794 SC</b> 1 x 1/2"x125,0



# Series

## Click-Torque Wrenches

### with reversible ratchet

#### Click-Torque B 1 torque wrench with reversible ratchet



**Application:** For clockwise torque-control

**Precision:** ± 3% of set value, as per DIN EN ISO 6789-1: 2017-07

**Design:** With  $\frac{3}{8}$ " square drive, reversible ratchet, 45 teeth; easy setting and saving of the desired torque value, with audible and tactile locking when the scale values are reached (fine scale only in Newton meters), audible and tactile release mechanism when the set torque value is reached

**Handle:** Ergonomic 2-component handle

		Nm	Nm	lb. ft.	mm	mm	mm	mm	mm	mm	mm	mm	mm	mm
05075610001	$\frac{3}{8}$ "	10-50	0,25	8-36	360	140	47	35	16,5	14 $\frac{11}{64}$ "	5 $\frac{33}{64}$ "	1 $\frac{27}{32}$ "	1 $\frac{3}{8}$ "	$\frac{5}{8}$ "

#### Click-Torque B 2 torque wrench with reversible ratchet



**Application:** For clockwise torque-control

Precision: ± 3% of set value, as per DIN EN ISO 6789-1: 2017-07

**Design:** With  $\frac{3}{8}$ " square drive, reversible ratchet, 45 teeth; easy setting and saving of the desired torque value, with audible and tactile locking when the scale values are reached (fine scale only in Newton meters), audible and tactile release mechanism when the set torque value is reached

**Handle:** Ergonomic 2-component handle

		Nm	Nm	lb. ft.	mm	mm	mm	mm	mm	mm	mm	mm	mm	mm
05075611001	$\frac{3}{8}$ "	20-100	0,5	15-73	405	140	47	43	18,5	15 $\frac{15}{16}$ "	5 $\frac{33}{64}$ "	1 $\frac{27}{32}$ "	1 $\frac{11}{16}$ "	$\frac{45}{64}$ "

### Click-Torque C 1 torque wrench with reversible ratchet



**Application:** For clockwise torque-control

**Precision:** ± 3% of set value, as per DIN EN ISO 6789-1: 2017-07

**Design:** With 1/2" square drive, reversible ratchet, 45 teeth; easy setting and saving of the desired torque value, with audible and tactile locking when the scale values are reached (fine scale only in Newton meters), audible and tactile release mechanism when the set torque value is reached

**Handle:** Ergonomic 2-component handle

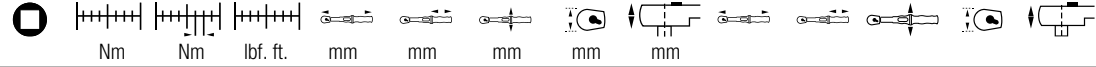
	
05075620001	1/2" 10-50 0,25 8-36 360 140 47 35 16,5 14 11/64" 5 33/64" 1 27/32" 1 3/8" 5/8"

### Click-Torque C 2 torque wrench with reversible ratchet



**Application:** For clockwise torque-control

**Precision:** ± 3% of set value, as per DIN EN ISO 6789-1: 2017-07

**Design:** With 1/2" square drive, reversible ratchet, 45 teeth; easy setting and saving of the desired torque value, with audible and tactile locking when the scale values are reached (fine scale only in Newton meters), audible and tactile release mechanism when the set torque value is reached

**Handle:** Ergonomic 2-component handle

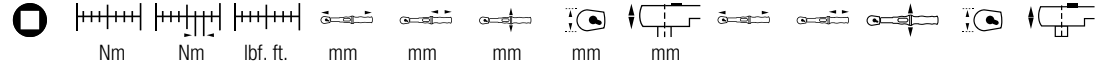
	
05075621001	1/2" 20-100 0,5 15-73 405 140 47 43 18,5 15 15/16" 5 33/64" 1 27/32" 1 11/16" 45/64"

# Series

## Click-Torque Wrenches

### with reversible ratchet

#### Click-Torque C 3 torque wrench with reversible ratchet



**Application:** For clockwise torque-control

**Precision:** ± 3% of set value, as per DIN EN ISO 6789-1: 2017-07

**Design:** With 1/2" square drive, reversible ratchet, 45 teeth; easy setting and saving of the desired torque value, with audible and tactile locking when the scale values are reached (fine scale only in Newton meters), audible and tactile release mechanism when the set torque value is reached

**Handle:** Ergonomic 2-component handle

		Nm	Nm	lbf. ft.	mm	mm	mm	mm	mm	mm	mm	mm	mm	mm
05075622001	1/2"	40-200	1,0	30-146	510	140	47	43	18,5	20 5/64"	5 33/64"	1 27/32"	1 11/16"	45/64"

#### Click-Torque C 4 torque wrench with reversible ratchet



**Application:** For clockwise torque-control

**Precision:** ± 3% of set value, as per DIN EN ISO 6789-1: 2017-07

**Design:** With 1/2" square drive, reversible ratchet, 45 teeth; easy setting and saving of the desired torque value, with audible and tactile locking when the scale values are reached (fine scale only in Newton meters), audible and tactile release mechanism when the set torque value is reached

**Handle:** Ergonomic 2-component handle

		Nm	Nm	lbf. ft.	mm	mm	mm	mm	mm	mm	mm	mm	mm	mm
05075623001	1/2"	60-300	1,0	45-220	595	140	47	43	18,5	23 27/64"	5 33/64"	1 27/32"	1 11/16"	45/64"



### Click-Torque C 5 torque wrench with reversible ratchet



**Application:** For clockwise torque-control

**Precision:** Accuracy  $\pm 3\%$  of set value, as per DIN EN ISO 6789-1: 2017-07; application range with up to max. 400 Nm above standard  
DIN EN ISO 6789-1: 2017-07 (maximum value: 340 Nm)

**Design:** With  $\frac{1}{2}$ " square drive, reversible ratchet, 45 teeth; easy setting and saving of the desired torque value, with audible and tactile locking when the scale values are reached (fine scale only in Newton meters), audible and tactile release mechanism when the set torque value is reached

**Handle:** Ergonomic 2-component handle

05075624001	$\frac{1}{2}$ " 80-400 1,0 60-295 680 140 47 43 18,5 26 $\frac{49}{64}$ " 5 $\frac{33}{64}$ " 1 $\frac{27}{32}$ " 1 $\frac{11}{16}$ " $\frac{45}{64}$ "

### Click-Torque E 1 torque wrench with reversible ratchet



**Application:** For clockwise torque-control

**Precision:**  $\pm 3\%$  of set value, as per DIN EN ISO 6789-1: 2017-07

**Design:** With  $\frac{3}{4}$ " square drive, reversible ratchet, 45 teeth; easy setting and saving of the desired torque value, with audible and tactile locking when the scale values are reached (fine scale only in Newton meters), audible and tactile release mechanism when the set torque value is reached

**Handle:** Ergonomic 2-component handle

05075630001	$\frac{3}{4}$ " 200-1000 1,0 148-737 1250 140 47 63 30 49 $\frac{7}{32}$ " 5 $\frac{33}{64}$ " 1 $\frac{27}{32}$ " 2 $\frac{31}{64}$ " 1 $\frac{3}{16}$ "

# Series

## Click-Torque Wrenches

with reversible ratchet

### Bicycle Set Torque 1



16 piece-set; in a surface protecting, compact and extremely robust textile box; low volume and weight for simplified mobility.

1 Click-Torque torque wrench A 5 with  $\frac{1}{4}$ " square drive, covering a range of 2.5 Nm-25 Nm, accuracy  $\pm 4\%$  of the set value, as per DIN EN ISO 6789-1: 2017-07, for clockwise torque control, reversible ratchet, 45 teeth, easy setting and saving of the desired torque value, with audible and tactile locking when the scale values are reached (fine scale only in Newton meters), audible and tactile release mechanism when the set torque value is reached, ergonomic 2-component handle, 4 Zyklop sockets, with  $\frac{1}{4}$ " drive, 4 Zyklop bit sockets for TORX® screws, with  $\frac{1}{4}$ " drive, with holding function, 7 bit sockets for hexagon socket screws with  $\frac{1}{4}$ " drive with holding function; Take it easy tool finder; Colour coding to enable the desired bit socket to be easily selected

05004180001	
	<b>Click-Torque A 5</b> 1 x $\frac{1}{4}$ " , 2,5-25 Nm
●	<b>8790 HMA</b> 1 x 10,0x23,0; 1 x 13,0x23,0; 1 x 14,0x23,0; 1 x 15,0x23,0
⊕	<b>8767 A HF</b> 1 x TX 10x28,0; 1 x TX 20x28,0; 1 x TX 25x28,0; 1 x TX 30x28,0
○	<b>8740 A HF</b> 1 x 3,0x28,0; 1 x 4,0x28,0; 1 x 5,0x28,0; 1 x 5,0x100,0; 1 x 6,0x28,0; 1 x 6,0x100,0; 1 x 8,0x28,0



# Series

## Click-Torque Wrenches

### for insert tools

#### Click-Torque X 1 torque wrench for insert tools



**Application:** For right and left-handed use

**Precision:** ± 4% of set value, as per DIN EN ISO 6789-1: 2017-07

**Design:** For 9x12 mm interchangeable insert tools; easy setting and saving of the desired torque value, with audible and tactile locking when the scale values are reached (fine scale only in Newton meters), audible and tactile release mechanism when the set torque value is reached

**Handle:** Ergonomic 2-component handle

	Nm	Nm	lbf. ft.	mm	mm	mm	mm	mm	mm	mm	mm	mm	mm	mm
05075651001	9x12	2,5-25	0,10	4-18	283	121	42	24	20	11 9/64"	4 49/64"	1 21/32"	15/16"	25/32"

#### Click-Torque X 2 torque wrench for insert tools



**Application:** For right and left-handed use

**Precision:** ± 3% of set value, as per DIN EN ISO 6789-1: 2017-07

**Design:** For 9x12 mm interchangeable insert tools; easy setting and saving of the desired torque value, with audible and tactile locking when the scale values are reached (fine scale only in Newton meters), audible and tactile release mechanism when the set torque value is reached

**Handle:** Ergonomic 2-component handle

	Nm	Nm	lbf. ft.	mm	mm	mm	mm	mm	mm	mm	mm	mm	mm	mm
05075652001	9x12	10-50	0,25	8-36	338	140	47	29	20	13 5/16"	5 33/64"	1 27/32"	1 9/64"	25/32"

### Click-Torque X 3 torque wrench for insert tools

















**Application:** For right and left-handed use

**Precision:** ± 3% of set value, as per DIN EN ISO 6789-1: 2017-07

**Design:** For 9x12 mm interchangeable insert tools; easy setting and saving of the desired torque value, with audible and tactile locking when the scale values are reached (fine scale only in Newton meters), audible and tactile release mechanism when the set torque value is reached

**Handle:** Ergonomic 2-component handle

														
	Nm	Nm	lbf. ft.	mm	mm	mm	mm	mm	mm	mm	mm	mm	mm	
05075653001	9x12	20-100	0,5	15-73	372	140	47	29	20	14 <sup>41</sup> / <sub>64</sub> "	5 <sup>33</sup> / <sub>64</sub> "	1 <sup>27</sup> / <sub>32</sub> "	1 <sup>9</sup> / <sub>64</sub> "	<sup>25</sup> / <sub>32</sub> "

### Click-Torque X 4 torque wrench for insert tools

















**Application:** For right and left-handed use

**Precision:** ± 3% of set value, as per DIN EN ISO 6789-1: 2017-07

**Design:** For 14x18 mm interchangeable insert tools; easy setting and saving of the desired torque value, with audible and tactile locking when the scale values are reached (fine scale only in Newton meters), audible and tactile release mechanism when the set torque value is reached

**Handle:** Ergonomic 2-component handle

														
	Nm	Nm	lbf. ft.	mm	mm	mm	mm	mm	mm	mm	mm	mm	mm	
05075654001	14x18	40-200	1,0	30-146	480	140	47	32	26	18 <sup>57</sup> / <sub>64</sub> "	5 <sup>33</sup> / <sub>64</sub> "	1 <sup>27</sup> / <sub>32</sub> "	1 <sup>17</sup> / <sub>64</sub> "	1 <sup>1</sup> / <sub>32</sub> "

# Series Click-Torque Wrenches for insert tools

## Click-Torque X 5 torque wrench for insert tools



















**Application:** For right and left-handed use

**Precision:** ± 3% of set value, as per DIN EN ISO 6789-1: 2017-07

**Design:** For 14x18 mm interchangeable insert tools; easy setting and saving of the desired torque value, with audible and tactile locking when the scale values are reached (fine scale only in Newton meters), audible and tactile release mechanism when the set torque value is reached

**Handle:** Ergonomic 2-component handle

																
		Nm	Nm	lb. ft.	mm	mm	mm	mm	mm	mm	mm	mm	mm	mm	mm	mm
05075655001	14x18	60-300	1,0	45-220	570	140	47	32	26	22 7/16"	5 33/64"	1 27/32"	1 17/64"	1 1/32"		

## Click-Torque X 6 torque wrench for insert tools



















**Application:** For right and left-handed use

**Precision:** ± 3% of set value, as per DIN EN ISO 6789-1: 2017-07; application range with up to max. 400 Nm above standard DIN EN ISO 6789-1: 2017-07 (maximum value: 340 Nm)

**Design:** For 14x18 mm interchangeable insert tools; easy setting and saving of the desired torque value, with audible and tactile locking when the scale values are reached (fine scale only in Newton meters), audible and tactile release mechanism when the set torque value is reached

**Handle:** Ergonomic 2-component handle

																
		Nm	Nm	lb. ft.	mm	mm	mm	mm	mm	mm	mm	mm	mm	mm	mm	mm
05075656001	14x18	80-400	1,0	60-295	655	140	47	32	26	25 25/32"	5 33/64"	1 27/32"	1 17/64"	1 1/32"		

# Series

## Click-Torque Wrenches

pre-set, for insert tools

### Click-Torque XP 1 pre-set adjustable torque wrench for insert tools



- Application:** For right and left-handed use  
**Pre-set torque:** 2.5 Nm  
**Precision:** ± 2% of set value, as per DIN EN ISO 6789-1: 2017-07  
**Design:** For 9x12 mm interchangeable insert tools; audible and tactile release mechanism when the set torque value is reached  
**Handle:** Ergonomic 2-component handle

		Nm	Nm	lbf. ft.	mm	mm	mm	mm	mm	mm	mm	mm	mm	
05075670001	9x12	2,5	2,5-25	2-18	217	137	35	24	20	8 <sup>35</sup> / <sub>64</sub> "	5 <sup>25</sup> / <sub>64</sub> "	1 <sup>21</sup> / <sub>32</sub> "	15/ <sub>16</sub> "	25/ <sub>32</sub> "
05075670010 <sup>1)</sup>	9x12	2,5	2,5-25	2-18	217	137	35	24	20	8 <sup>35</sup> / <sub>64</sub> "	5 <sup>25</sup> / <sub>64</sub> "	1 <sup>21</sup> / <sub>32</sub> "	15/ <sub>16</sub> "	25/ <sub>32</sub> "

<sup>1)</sup> Any presetting which differs from this value, can be set to a desired torque value within the specified metered range upon request.

### Click-Torque XP 2 pre-set adjustable torque wrench for insert tools



- Application:** For right and left-handed use  
**Pre-set torque:** 10.0 Nm  
**Precision:** ± 2% of set value, as per DIN EN ISO 6789-1: 2017-07  
**Design:** For 9x12 mm interchangeable insert tools; audible and tactile release mechanism when the set torque value is reached  
**Handle:** Ergonomic 2-component handle

		Nm	Nm	lbf. ft.	mm	mm	mm	mm	mm	mm	mm	mm	mm	
05075671001	9x12	10,0	10-50	8-36	262	137	35	24	20	10 <sup>5</sup> / <sub>16</sub> "	5 <sup>25</sup> / <sub>64</sub> "	1 <sup>3</sup> / <sub>8</sub> "	15/ <sub>16</sub> "	25/ <sub>32</sub> "
05075671010 <sup>1)</sup>	9x12	10,0	10-50	8-36	262	137	35	24	20	10 <sup>5</sup> / <sub>16</sub> "	5 <sup>25</sup> / <sub>64</sub> "	1 <sup>3</sup> / <sub>8</sub> "	5/ <sub>16</sub> "	25/ <sub>32</sub> "

<sup>1)</sup> Any presetting which differs from this value, can be set to a desired torque value within the specified metered range upon request.

# Series















## Click-Torque Wrenches

pre-set, for insert tools

### Click-Torque XP 3 pre-set adjustable torque wrench for insert tools



- Application:** For right and left-handed use  
**Pre-set torque:** 15.0 Nm  
**Precision:** ± 2% of set value, as per DIN EN ISO 6789-1: 2017-07  
**Design:** For 9x12 mm interchangeable insert tools; audible and tactile release mechanism when the set torque value is reached  
**Handle:** Ergonomic 2-component handle















														
		Nm	Nm	lbf. ft.	mm	mm	mm	mm	mm	mm	mm	mm	mm	mm
05075672001	9x12	15,0	15-100	11-74	332	137	35	24	20	13 5/64"	5 25/64"	1 3/8"	15/16"	25/32"
05075672010 <sup>1)</sup>	9x12	15,0	15-100	11-74	332	137	35	24	20	13 5/64"	5 25/64"	1 3/8"	15/16"	25/32"

<sup>1)</sup> Any presetting which differs from this value, can be set to a desired torque value within the specified metered range upon request.

### Click-Torque XP 4 pre-set adjustable torque wrench for insert tools



- Application:** For right and left-handed use  
**Pre-set torque:** 20.0 Nm  
**Precision:** ± 2% of set value, as per DIN EN ISO 6789-1: 2017-07  
**Design:** For 14x18 mm interchangeable insert tools; audible and tactile release mechanism when the set torque value is reached  
**Handle:** Ergonomic 2-component handle

														
		Nm	Nm	lbf. ft.	mm	mm	mm	mm	mm	mm	mm	mm	mm	mm
05075673001	14x18	20,0	20-250	15-184	457	145	41	32	26	17 63/64"	5 45/64"	1 39/64"	1 17/64"	1 1/32"
05075673010 <sup>1)</sup>	14x18	20,0	20-250	15-184	457	145	41	32	26	17 63/64"	5 45/64"	1 39/64"	1 17/64"	1 1/32"

<sup>1)</sup> Any presetting which differs from this value, can be set to a desired torque value within the specified metered range upon request.



## Tip

### Click-Torque XP



The Click-Torque XP torque wrenches are provided with pre-set torque values. These tools are ideal for all applications where the same torque and repeat accuracy is required.

### Individual pre-setting



The Click-Torque XP torque wrenches with a pre-set torque value can be set to any value within the specified metered range in the test laboratory.



# Series Insert Tools

Suitable for Series Click-Torque X and XP wrenches

## 7770 Open end insert

### Form A

0507860001  
05078601001  
05078602001  
05078603001  
05078604001  
05078605001







### Form B

05078606001  
05078607001  
05078608001  
05078609001  
05078610001  
05078611001  
05078612001



**Application:** Hexagon screw heads or nuts  
**Drive:** 9x12 mm; for torque wrenches of the Click-Torque X and XP series with 9x12 mm holder  
**Design:** Forged, chrome vanadium steel, matt chrome plated; with safety pin

					
	mm	mm	mm	mm	mm
05078600001	7	39,0	22,0	22,0	5,0
05078601001	8	39,0	22,0	22,0	5,0
05078602001	9	39,0	22,0	22,0	5,0
05078603001	10	39,0	22,0	22,0	5,0
05078604001	11	39,0	22,0	22,0	5,0
05078605001	12	39,0	22,0	22,0	5,0
05078606001	13	41,0	24,0	30,0	7,0
05078607001	14	41,0	24,0	30,0	7,0
05078608001	15	41,0	24,0	30,0	7,0
05078609001	16	41,0	24,0	30,0	7,0
05078610001	17	41,0	24,0	30,0	7,0
05078611001	18	41,0	24,0	30,0	7,0
05078612001	19	41,0	24,0	30,0	7,0

## 7780 Open end insert

### Form A

05078670001



### Form B

05078671001  
05078672001  
05078673001  
05078674001  
05078675001  
05078676001



### Form C

05078677001  
05078678001  
05078679001  
05078680001  
05078681001







### Form D



05078682001  
05078683001  
05078684001  
05078685001  
05078686001  
05078687001



**Application:** Hexagon screw heads or nuts  
**Drive:** 14x18 mm; for torque wrenches of the Click-Torque X and XP series with 14x18 mm holder  
**Design:** Forged, chrome vanadium steel, matt chrome plated; with safety pin

					
	mm	mm	mm	mm	mm
05078670001	13	56,0	32,0	30,0	7,0
05078671001	14	58,0	33,0	32,0	8,0
05078672001	15	58,0	33,0	32,0	8,0
05078673001	16	58,0	33,0	32,0	9,0
05078674001	17	58,0	33,0	32,0	9,0
05078675001	18	58,0	33,0	32,0	9,7
05078676001	19	58,0	33,0	32,0	9,7
05078677001	21	61,0	36,0	52,0	11,0
05078678001	22	61,0	36,0	52,0	11,0
05078679001	24	61,0	36,0	52,0	12,0
05078680001	26	61,0	36,0	52,0	13,0
05078681001	27	61,0	36,0	52,0	13,0
05078682001	29	61,0	36,0	52,0	14,0
05078683001	30	61,0	36,0	52,0	14,0
05078684001	32	61,0	36,0	52,0	14,0
05078685001	36	61,0	36,0	52,0	15,0
05078686001	38	61,0	36,0	52,0	15,0
05078687001	41	61,0	36,0	52,0	15,0





### 7771 Ring spanner insert

<p><b>Form A</b></p> <p>05078620001 05078621001 05078622001 05078623001 05078624001</p> 
<p><b>Form B</b></p> <p>05078625001 05078626001 05078627001 05078628001 05078629001 05078630001 05078631001 05078632001</p> 
<p><b>Form C</b></p> <p>05078633001</p> 



**Application:** Hexagon screw heads or nuts

**Drive:** 9x12 mm; for torque wrenches of the Click-Torque X and XP series with 9x12 mm holder

**Design:** Forged, chrome vanadium steel, matt chrome plated; with safety pin

					
	mm	mm	mm	mm	mm
05078620001	7	41,0	24,0	22,0	8,0
05078621001	8	41,0	24,0	22,0	8,0
05078622001	9	41,0	24,0	22,0	8,0
05078623001	10	41,0	24,0	22,0	8,0
05078624001	11	41,0	24,0	22,0	8,0
05078625001	12	44,0	27,0	22,0	11,0
05078626001	13	44,0	27,0	22,0	11,0
05078627001	14	44,0	27,0	22,0	11,0
05078628001	15	44,0	27,0	22,0	11,0
05078629001	16	44,0	27,0	22,0	11,0
05078630001	17	44,0	27,0	22,0	11,0
05078631001	18	44,0	27,0	22,0	11,0
05078632001	19	44,0	27,0	22,0	11,0
05078633001	21	51,0	34,0	33,0	15,0





### 7781 Ring spanner insert

<p><b>Form A</b></p> <p>05078690001 05078691001 05078692001</p> 
<p><b>Form B</b></p> <p>05078693001 05078694001 05078695001 05078696001 05078697001 05078698001 05078699001</p> 
<p><b>Form C</b></p> <p>05078700001 05078701001 05078702001 05078703001 05078704001 05078705001</p> 

**Application:** Hexagon screw heads or nuts

**Drive:** 14x18 mm; for torque wrenches of the Click-Torque X and XP series with 14x18 mm holder

**Design:** Forged, chrome vanadium steel, matt chrome plated; with safety pin

					
	mm	mm	mm	mm	mm
05078690001	13	62,0	37,0	30,0	11,0
05078691001	14	62,0	37,0	30,0	11,0
05078692001	15	62,0	37,0	30,0	11,0
05078693001	16	64,0	39,0	28,0	12,0
05078694001	17	64,0	39,0	28,0	12,0
05078695001	18	64,0	39,0	28,0	12,0
05078696001	19	64,0	39,0	28,0	12,0
05078697001	21	64,0	39,0	28,0	12,0
05078698001	22	64,0	39,0	28,0	12,0
05078699001	24	64,0	39,0	28,0	12,0
05078700001	27	81,0	56,0	53,0	21,0
05078701001	30	81,0	56,0	53,0	21,0
05078702001	32	81,0	56,0	53,0	21,0
05078703001	34	81,0	56,0	53,0	21,0
05078704001	36	81,0	56,0	53,0	21,0
05078705001	41	81,0	56,0	53,0	21,0

# Series Insert Tools

## Suitable for Series Click-Torque X and XP wrenches

### 7772 A Ratchet insert, reversible



**Application:** For 1/4" square socket wrench inserts and 1/4" connecting parts with square drive

**Drive:** 9x12 mm; for torque wrenches of the Click-Torque X and XP series with 9x12 mm holder

**Design:** With reversing ratchet, push-button release, forged, chrome-vanadium steel, matt chrome-plated; with safety pin

		mm	mm	mm	mm
05078635001	1/4"	49,0	32,0	28,0	15,0

### 7772 B Ratchet insert, reversible



**Application:** For 3/8" square socket wrench inserts and 3/8" connecting parts with square drive

**Drive:** 9x12 mm; for torque wrenches of the Click-Torque X and XP series with 9x12 mm holder

**Design:** With reversing ratchet, push-button release, forged, chrome-vanadium steel, matt chrome-plated; with safety pin

		mm	mm	mm	mm	mm
05078636001	3/8"	52,0	35,0	35,0	21,0	

### 7772 C Ratchet insert, reversible



**Application:** For 1/2" square socket wrench inserts and 1/2" connecting parts with square drive

**Drive:** 9x12 mm; for torque wrenches of the Click-Torque X and XP series with 9x12 mm holder

**Design:** With reversing ratchet, push-button release, forged, chrome-vanadium steel, matt chrome-plated; with safety pin

		mm	mm	mm	mm	mm
05078637001	1/2"	58,0	41,0	42,0	23,0	

### 7782 E Ratchet insert, reversible



**Application:** For 3/4" square socket wrench inserts and 3/4" connecting parts with square drive

**Drive:** 14x18 mm; for torque wrenches of the Click-Torque X and XP series with 14x18 mm holder

**Design:** With reversing ratchet, push-button release, forged, chrome-vanadium steel, matt chrome-plated; with safety pin

		mm	mm	mm	mm	mm
05078708001	3/4"	90,0	65,0	65,0	36,0	

### 7782 C Ratchet insert, reversible



**Application:** For 1/2" square socket wrench inserts and 1/2" connecting parts with square drive

**Drive:** 14x18 mm; for torque wrenches of the Click-Torque X and XP series with 14x18 mm holder

**Design:** With reversing ratchet, push-button release, forged, chrome-vanadium steel, matt chrome-plated; with safety pin

		mm	mm	mm	mm	mm
05078707001	1/2"	66,0	41,0	42,0	23,0	

### 7773 A Square drive insert



**Application:** For 1/4" square socket wrench inserts and 1/4" connecting parts with square drive

**Drive:** 9x12 mm; for torque wrenches of the Click-Torque X and XP series with 9x12 mm holder

**Design:** Forged, chrome-vanadium steel, matt chrome-plated; with safety pin

		mm	mm	mm	mm	mm
05078200001	1/4"	44,0	28,0	21,0	14,0	

### 7773 B Square drive insert



**Application:** For  $\frac{3}{8}$ " square socket wrench inserts and  $\frac{3}{8}$ " connecting parts with square drive

**Drive:** 9x12 mm; for torque wrenches of the Click-Torque X and XP series with 9x12 mm holder

**Design:** Forged, chrome-vanadium steel, matt chrome-plated; with safety pin

		mm	mm		
05078205001	$\frac{3}{8}$ "	44,0	28,0	21,0	14,0

### 7783 C Square drive insert



**Application:** For  $\frac{1}{2}$ " square socket wrench inserts and  $\frac{1}{2}$ " connecting parts with square drive

**Drive:** 14x18 mm; for torque wrenches of the Click-Torque X and XP series with 14x18 mm holder

**Design:** Forged, chrome-vanadium steel, matt chrome-plated; with safety pin

		mm	mm		
05078345001	$\frac{1}{2}$ "	65,0	40,0	30,0	18,0

### 7773 C Square drive insert



**Application:** For  $\frac{1}{2}$ " square socket wrench inserts and  $\frac{1}{2}$ " connecting parts with square drive

**Drive:** 9x12 mm; for torque wrenches of the Click-Torque X and XP series with 9x12 mm holder

**Design:** Forged, chrome-vanadium steel, matt chrome-plated; with safety pin

		mm	mm	mm	mm
05078210001	$\frac{1}{2}$ "	44,0	28,0	21,0	14,0

### 7774/1 Bit adapter insert, $\frac{1}{4}$ "



**Application:** Suitable for  $\frac{1}{4}$ " DIN ISO 1173-C 6,3 hexagon insert bits and Wera Series 1

**Drive:** 9x12 mm; for torque wrenches of the Click-Torque X and XP series with 9x12 mm holder

**Design:** Forged, chrome-vanadium steel, matt chrome-plated; with safety pin

		mm	mm	mm	mm
05078640001	$\frac{1}{4}$ "	42,0	25,0	22,0	12,5

### 7783 E Push-through square insert tool

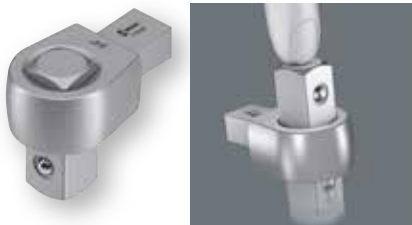

**Application:** For  $\frac{1}{2}$ " square socket wrench inserts and  $\frac{3}{4}$ " connecting parts with square drive

**Drive:** 14x18 mm; for torque wrenches of the Click-Torque X and XP series with 14x18 mm holder

**Design:** With push-through square with ball lock, forged, chrome-vanadium steel, matt chrome-plated; with safety pin

		mm	mm	mm	mm
05078710001	$\frac{3}{4}$ "	70,0	45,0	40,0	25,0

### 7774/2 Bit adapter insert, $\frac{5}{16}$ "



**Application:** Suitable for  $\frac{5}{16}$ " DIN ISO 1173-E 8 hexagon insert bits and Wera Series 2

**Drive:** 9x12 mm; for torque wrenches of the Click-Torque X and XP series with 9x12 mm holder

**Design:** Forged, chrome-vanadium steel, matt chrome-plated; with safety pin

		mm	mm	mm	mm
05078641001	$\frac{5}{16}$ "	42,0	25,0	22,0	12,5

# Series Insert Tools

## Suitable for Series Click-Torque X and XP wrenches





### 7774/3 Bit adapter insert, 5/16" "



**Application:** Suitable for 5/16" DIN ISO 1173-E 8 hexagon insert bits and Wera Series 2

**Drive:** 14x18 mm; for torque wrenches of the Click-Torque X and XP series with 14x18 mm holder

**Design:** Forged, chrome-vanadium steel, matt chrome-plated; with safety pin

					
	mm	mm	mm	mm	mm
05078642001	5/16"	58,0	33,0	30,0	13,0

### 7776 External TORX® insert

#### Form A

05078660001  
05078661001  
05078662001  
05078663001



#### Form B





05078664001



**Application:** External TORX® screws

**Drive:** 9x12 mm; for torque wrenches of the Click-Torque X and XP series with 9x12 mm holder

**Design:** Forged, chrome-vanadium steel, matt chrome-plated; with safety pin

					
	mm	mm	mm	mm	mm
05078660001	TX 6	40,0	23,0	22,0	8,0
05078661001	TX 8	40,0	23,0	22,0	8,0
05078662001	TX 10	40,0	23,0	22,0	8,0
05078663001	TX 12	40,0	23,0	22,0	8,0
05078664001	TX 14	45,0	28,0	22,0	11,0

### 7775 Open ring spanner insert

#### Form A

05078650001  
05078651001  
05078652001  
05078653001  
05078654001  
05078655001



#### Form B





05078656001  
05078657001  
05078658001



**Application:** Hexagon screw heads or nuts

**Drive:** 9x12 mm; for torque wrenches of the Click-Torque X and XP series with 9x12 mm holder

**Design:** Forged, chrome vanadium steel, matt chrome plated; with safety pin

					
	mm	mm	mm	mm	mm
05078650001	10	44,0	27,0	22,0	11,0
05078651001	11	44,0	27,0	22,0	11,0
05078652001	12	44,0	27,0	22,0	11,0
05078653001	13	44,0	27,0	22,0	11,0
05078654001	14	44,0	27,0	22,0	11,0
05078655001	17	44,0	27,0	22,0	11,0
05078656001	18	49,0	32,0	33,0	15,0
05078657001	19	49,0	32,0	33,0	15,0
05078658001	22	49,0	32,0	33,0	15,0

### 7786 External TORX® insert

#### Form A

05078714001  
05078715001



#### Form B





05078716001  
05078717001



**Application:** External TORX® screws

**Drive:** 14x18 mm; for torque wrenches of the Click-Torque X and XP series with 14x18 mm holder

**Design:** Forged, chrome-vanadium steel, matt chrome-plated; with safety pin

					
	mm	mm	mm	mm	mm
05078714001	TX 14	37,0	62,0	30,0	11,0
05078715001	TX 18	37,0	62,0	30,0	11,0
05078716001	TX 20	40,0	65,0	32,0	12,0
05078717001	TX 24	40,0	65,0	32,0	12,0







### 7779/1 Adapter insert



**Application:** For the use of square plug-in tools 14x18 mm in torque wrenches with internal square 9x12 mm

**Drive:** 9x12 mm; for torque wrenches of the Click-Torque X and XP series with 9x12 mm holder

**Design:** Forged, chrome vanadium steel, matt chrome plated; with safety pin

						
	mm	mm	mm	mm	mm	mm
05078666001	14x18	9x12	49,0	33,0	32,0	26,0







### 7779/2 Adapter insert



**Application:** For the use of square plug-in tools 9x12 mm in torque wrenches with internal square 14x18 mm

**Drive:** 14x18 mm; for torque wrenches of the Click-Torque X and XP series with 14x18 mm holder

**Design:** Forged, chrome vanadium steel, matt chrome plated; with safety pin

						
	mm	mm	mm	mm	mm	mm
05078667001	9x12	14x18	52,0	27,0	28,0	21,0





### 7790/1 Push-fit weld-on adapter



**Application:** For welding on specifically required tools

**Drive:** 9x12 mm; for torque wrenches of the Click-Torque X and XP series with 9x12 mm holder

**Design:** Forged, phosphated, with safety pin

				
	mm	mm	mm	mm
05078720001	24,0	8,0	22,0	14,0





### 7790/2 Push-fit weld-on adapter



**Application:** For welding on specifically required tools

**Drive:** 14x18 mm; for torque wrenches of the Click-Torque X and XP series with 14x18 mm holder

**Design:** Forged, phosphated, with safety pin

					
	mm	mm	mm	mm	mm
05078721001	38,0	13,0	31,0	22,0	26,0







# Regional Contacts



## Wera Werkzeuge GmbH

Korzerter Straße 21-25  
42349 Wuppertal

+49 / (0)202 / 40 45 - 0  
Fax: +49 / (0)202 / 40 36 34

E-Mail: [info@wera.de](mailto:info@wera.de)



## Germany

04654 Frohburg  
Industrievertretung Jens Hiensch  
+49 / (0)157 / 71 90 78 21  
E-Mail: [jens.hiensch@iv-hiensch.de](mailto:jens.hiensch@iv-hiensch.de)

26160 Bad Zwischenahn  
Ralf Saul  
+49 / (0)4403 / 91 00 972  
E-Mail: [r.saul@wera.de](mailto:r.saul@wera.de)

78132 Hornberg  
Industrievertretung Markus Haberstroh  
+49 / (0)7833 / 955 54 86  
E-Mail: [m.haberstroh@haberstroh-industrievertretung.de](mailto:m.haberstroh@haberstroh-industrievertretung.de)

09326 Geringswalde  
IMS Lonhoff  
+49 / (0)1525 / 39 81 570  
E-Mail: [info@ims-lonhoff.de](mailto:info@ims-lonhoff.de)

42349 Wuppertal  
Dirk Blasius - Verkaufsleiter NRW  
+49 / (0)202 / 40 45 204  
E-Mail: [blasius@wera.de](mailto:blasius@wera.de)

88489 Wain  
Thorsten Schilder Handelsvertretung  
+49 / (0)7353 / 528 48 74  
E-Mail: [thorsten.schilder@wera.de](mailto:thorsten.schilder@wera.de)

10961 Berlin  
Werksvertretung Peter Raschke  
+49 / (0)177 / 74 90 484  
E-Mail: [raschke@ww-raschke.de](mailto:raschke@ww-raschke.de)

58256 Ennepetal  
Ulrich Hesselmann  
+49 / (0)2333 / 83 92 37  
E-Mail: [ulrich.hesselmann@wera.de](mailto:ulrich.hesselmann@wera.de)

90455 Nürnberg  
Dietz OHG  
+49 / (0)9129 / 90 57 50  
E-Mail: [dietz@wera.de](mailto:dietz@wera.de)

21465 Reinbek  
Rosendahl & Koppel  
Inh. Mark Petersen e.K.  
+49 / (0)40 / 23 41 47  
E-Mail: [mark.petersen@roko-petersen.de](mailto:mark.petersen@roko-petersen.de)

64342 Seeheim-Jugenheim  
Layer OHG  
+49 / (0)6257 / 86 96 0  
E-Mail: [info@layer-ohg.de](mailto:info@layer-ohg.de)

## Europe



AT - 5412 Puch  
Alpen-MayKestag GmbH  
+43 / (0)662 / 44 901-0  
E-Mail: [verkauf@a-mk.com](mailto:verkauf@a-mk.com)



Wera Werkzeuge GmbH  
C./Mogoda, 1-5 (Edificio Nodus)  
Pno. Ind. Can Salvatell  
E - 08210 Barberà del Vallès / Barcelona  
+34 / 93 / 7 29 7-2 40  
Fax: +34 / 93 / 7 29 7-2 41  
E-Mail: [ventas@weraspain.com](mailto:ventas@weraspain.com)



Wera Tools (UK) Ltd.  
Railway View  
Clay Cross  
Chesterfield  
S45 9FR  
+44 (0)1246 / 277756  
Fax: +44 (0)1246 / 273335  
E-Mail: [queries@wera-tools.co.uk](mailto:queries@wera-tools.co.uk)



B - 1600 Sint-Pieters-Leeuw  
Beltracy S.A.  
+32 / (0)2 / 54 36 890  
E-Mail: [info@beltracy.be](mailto:info@beltracy.be)



EST - 1415 Tallinn  
AS Stokker  
+372 / 6 / 20 11 11  
E-Mail: [timmo.eenmaa@stokker.com](mailto:timmo.eenmaa@stokker.com)



GR - 166 72 Vari  
Costas J. Kessissoglou  
+30 / 210 / 96 37-520  
E-Mail: [kessi@cosmotemail.gr](mailto:kessi@cosmotemail.gr)



BG - 1421 Sofia  
Mr. Nikola Ivanov  
+359 8865 11 585  
E-Mail: [weraw@mail.bg](mailto:weraw@mail.bg)



EST - 12618 Tallinn  
Toolmarketing OÜ  
+372 / 6 / 09 64 36  
E-Mail: [info@toolmarketing.eu](mailto:info@toolmarketing.eu)



I - 20097 San Donato Milanese  
Carlo Stechel & Figli srl  
+39 / 02 52 77 71  
E-Mail: [wera@stechel.it](mailto:wera@stechel.it)



CH - 6260 Reiden  
Hauptstrasse 26  
PREMIUM TOOLS AG  
+41 62 749 10 00  
Fax: +41 62 749 10 01  
E-Mail: [info@premiumtools.ag](mailto:info@premiumtools.ag)



Wera Outillages S.A.S.  
13, rue Ampère  
F - 67500 Haguenau  
+33 9 72 61 16 52  
E-Mail: [info@wera-outillages.fr](mailto:info@wera-outillages.fr)



NL - Mitte  
Gerard Kluck  
+31 / 65 28 52 622  
E-Mail: [kluck@wera.de](mailto:kluck@wera.de)



CZ - 180 82 Praha 8  
ABQ AGENCY s.r.o.  
+420 / (0)2 / 28 38 41 981  
E-Mail: [info@abefekt.cz](mailto:info@abefekt.cz)



Wera Tools Finland Oy  
Henry Ahokas  
Karhumäentie 3  
01530 Vantaa  
+358 45 206 9556  
E-Mail: [ahokas@wera.de](mailto:ahokas@wera.de)



NL - Süd  
Wouter Steijvers  
+31 / 65 28 50 162  
E-Mail: [steijvers@wera.de](mailto:steijvers@wera.de)



NL - Nord  
Frederik Koning  
+31 (0)6 15 26 36 97  
E-Mail: [koning@wera.de](mailto:koning@wera.de)

# Regional Contacts

## Europe

 LT-69320 Klaipėdos raj.  
**UAB GITANA**  
☎ +370 / 46 / 410881  
E-Mail: info@gitana.lt

 RO-400441 Cluj-Napoca  
**Mr. Victor Martes**  
☎ +40 / 741 / 072 479  
E-Mail: wera@easy-pro.ro

 S - 163 53 Spånga  
**Hansson & Frife AB**  
☎ +46 / (0)8 / 76 02 510  
E-Mail: hansson.frife@esma.se

 N - 0787 Oslo  
**MORGENSTIERNE verktøy AS**  
☎ +47 / (0)22 / 49 28 00  
E-Mail: tools@morgenstierne.no

 RUS - 119454 Moskau  
**KNIPEX 000**  
☎ +7 / 495 / 73 73 497  
E-Mail: info@knipec.ru

 SRB-11030 Beograd  
**ELTEC Export-Import d.o.o.**  
☎ +381 / 11 / 3555 - 065  
E-Mail: info@eltec.rs

 PL - 61-306 Poznań  
**Agentools Sp. z o.o. Sp. k.**  
☎ +48 / (0)61 / 87 19 000  
E-Mail: info@agentools.pl

 RUS-143581 Moskau  
**ООО „ЦИТ“ ЦЕНТРОИНСТРУМЕНТ**  
☎ +7- / 495 / 789 73 14/15  
E-Mail: wera@centro-i.ru

## North America (Canada, USA, Mexico)

  CA - Burlington, Ontario  
**Wera Tools Inc.**  
☎ 1 - 800 - 267 - 5541  
E-Mail: info@weratools.com

  CA - Burlington, Ontario  
**Wera Tools Inc.**  
☎ 1 - 800 - 267 - 5541  
E-Mail: info@weratools.com

  CA - Burlington, Ontario  
**Wera Tools Inc.**  
☎ + 1 - 905 - 637 - 0003  
E-Mail: info@weratools.com

## South America

 AR - 1879 Buenos Aires  
**Quilmes Neumática S.A.**  
☎ +54 / 11 42 50 03 65 int.21  
E-Mail: rudi@quilmesneumatica.com

 BR - 09601-000 São Bernardo do Campo-SP  
**DFG Comércio Importação  
Exportação e Representação Ltda**  
☎ +55 / 11 49 41 21 51  
E-Mail: www.dfgferramentas.com.br

 CL - Santiago de Chile  
**Comercial e Industrial Ilesa S.A.**  
☎ +56 / 23 62 70 00

## Australia and Oceania

 AU - Australia - 2147 Seven Hills  
**Cabac**  
☎ +61 / 13 31 22  
E-Mail: sales@cabac.com.au

 NZ - 1060 Auckland  
**Ecco Pacific Ltd.**  
☎ +64 0800 77 6969  
E-Mail: sales@cabac.co.nz

 NZ - 8023 Christchurch  
**Blacks Fasteners**  
☎ +64-3-3652460  
E-Mail: sydenham@blacksfasteners.co.nz

## Asia

 CN - 201206 Shanghai  
**KNIPEX Tools Co., Ltd.**  
☎ +86 / 21 58 99 80 10  
E-Mail: info@knipec.com.cn

  Wera Tools  
**Japan G.K.**  
☎ +81 70 4813 1142  
E-Mail: frank.yang@wera.de

 SG - 575625 Singapore  
**Wing Poh Hardware Pte Ltd**  
☎ +65 / 62 50 05 23

 Matfron Industrial Automatic  
**(Shanghai) Co., Ltd**  
☎ +86 / 021 / 66 24 91 22  
E-Mail: service@matfron.com

 IN - 411001 Pune  
**Nikita Distributors & Extreme  
Adventure Sports**  
☎ +91 / 20 30 50 06 14  
E-Mail: raman.jpa@gmail.com

 TW - 114 Taipei City / Taiwan R.O.C  
**Inhand Corporation**  
☎ +886 / 2 / 63 19 53 8

 KR - 10463 Gyeonggi-Do  
**LnJ Korea**  
☎ +82 / 31 / 96 61 429  
E-Mail: LNj2100@gmail.com

 IN - 600 125 Chennai  
**Rapidtec Enterprises**  
☎ +91 994 036 6621  
E-Mail: rapidtec2011@gmail.com

 TW - 11483 Taipei / Taiwan R.O.C.  
**Duramet Corporation**  
☎ +886 / 2 / 26 32 24 88

 KR - 08531 Seoul  
**Protool Co., LTD.**  
E-Mail: sejin@protool.co.kr

 VN - Ho Chi Minh City, Vietnam  
**THE GIOI MOI EQUIPMENT AND ENGINEERING  
SOLUTION JOINT STOCK COMPANY (THE GIOI MOI JSC)**  
☎ +84-28-66 80 88 75  
E-Mail: thegioimoijscvn@gmail.com

## Middle East

 IL - Tel-Aviv 61573  
**Tenegal Agencies Ltd.**  
☎ +972 / (0)3 / 56 17 411  
E-Mail: menahem@tenegal.com

JO, LB, IR, SY, KW, BH, QA, OM, AE, SA, JE  
**KNIPEX Tools Middle East FZE**  
☎ +971 / 48 87 85 56  
E-Mail: info@knipec-tools.com

 IR - 15866-45915 Tehran / Iran  
**Abzarsara Co.**  
☎ +98 / 21 88 81 31 20  
E-Mail: info@abzarsara.com



 IR - 15866-45915 Tehran / Iran  
**FourSat Kish Co Ltd.**  
☎ +98 / 21 88 60 24 84  
E-Mail: arash.etminan@foursat.com



## Contact us

**All regions (except for North America, UK and Republic of Ireland)**

**Wera Werkzeuge GmbH** · Germany

Korzerter Straße 21–25

D-42349 Wuppertal

Phone: +49 (0) 202 / 40 45-0

Fax: +49 (0) 202 / 40 45 276

E-Mail: [info@wera.de](mailto:info@wera.de)

Internet: [www.wera.de](http://www.wera.de)

### **North America**

**Wera Tools Inc.**

4129 Harvester Rd, Unit H

Burlington, Ontario

Canada, L7L 5M3

Phone: 1-800-267-55 41

E-Mail: [info@weratools.com](mailto:info@weratools.com)

Internet: [www.weratools.com](http://www.weratools.com)

### **UK & Republic of Ireland**

**Wera Tools UK LTD**

Railway View

Clay Cross

Chesterfield

Derbyshire, S45 9FR

Great Britain

Phone: +44 / (0) 12 46 / 27 77 56

E-Mail: [queries@wera-tools.co.uk](mailto:queries@wera-tools.co.uk)

Internet: [www.wera-tools.co.uk](http://www.wera-tools.co.uk)

Subject to technical modifications!

Any reprinting – even only excerpts – shall only be permissible with the prior written consent of the company Wera Werkzeuge GmbH.

We reserve the right to modify without prior notification any details stated in this catalogue regarding product features, versions and designs. No liability for printing errors or mistakes shall be assumed.

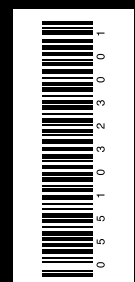

EN 05 510323 001 - 0056294 - 02