

TIMKEN



TIMKEN® THRUST BEARING CATALOG



THRUST BEARING CATALOG INDEX

TIMKEN OVERVIEW	2
PRODUCTS AND SERVICES	5
HOW TO USE THIS CATALOG	9
SHELF LIFE AND STORAGE	10
WARNINGS AND CAUTIONS	12
ENGINEERING	13
Thrust Bearing Types	14
Bearing Reactions	20
Bearing Ratings	22
System Life and Weighted Average Load and Life	28
Bearing Tolerances, Metric and Inch Systems	29
Mounting Design, Fitting Practice and Setting	37
Bearing Operation	51
Lubrication	55
PRODUCT DATA TABLES	65
Nomenclature	66
Angular Contact Thrust Ball Bearings	69
Thrust Cylindrical Roller Bearings	75
Thrust Spherical Roller Bearings	85
Thrust Tapered Roller Bearings	93



GROW STRONGER WITH TIMKEN

Every day, people around the world count on the strength of Timken. Our expertise in metallurgy, friction management and mechanical power transmission helps them accelerate improvements in productivity and uptime.

We supply products and services that can help keep your operations moving forward, whether you need drive train kits for commercial vehicles, durable housings for bearings in dirty environments, couplings that avoid metal-to-metal contact between motors and gearboxes, repair services for bearings and gearboxes, roller chain for dry, abrasive and high-moisture applications, or other products and services for your applications.

When you choose Timken, you receive more than high-quality products and services: you gain a worldwide team of highly trained and experienced Timken people committed to working collaboratively with you to improve your business.

Globally, our 17,000 people provide reliable answers for a wide range of operations in manufacturing, mining, medical equipment, aerospace, transportation, oil and gas – and other diverse industries.



INCREASE YOUR EQUIPMENT UPTIME

In addition to high-quality bearings and mechanical power transmission components, we provide valuable integrated products and services. For example, we offer repair services and monitoring equipment that can alert you to problems before they impact your uptime.

Additionally, we offer a broad selection of seals, premium lubricants, lubricators, couplings and chain to keep your operations moving smoothly.

Our 12 technology centers in the United States, Europe and Asia help pioneer tomorrow's innovations with extensive basic and applied scientific research programs. Through internal development and strategic acquisition of innovative companies, we continue to expand our portfolio of highly engineered bearings, power transmission products and advanced services.



INDUSTRIAL INNOVATOR

Today, manufacturing and processing equipment handle heavier loads, faster speeds and greater expectations than ever before. As finished-product quality requirements increase, producers continue to place a very high premium on equipment uptime and performance.

Timken has more than a century of experience developing bearings and related solutions that help equipment run more efficiently in a wide range of applications. As the leader in friction-management and power-transmission solutions for industrial markets, Timken helps operators improve their equipment's performance and uptime. We accomplish this by providing custom solutions – from bearings that stand-up to the harshest environments to condition monitoring that minimizes maintenance costs and improves plant productivity.

INNOVATION AND CUSTOMER SUPPORT

Timken operates technology centers around the world dedicated to developing innovative concepts and products that help you operate more efficiently. Our technical leadership and customer support reach far beyond our products. Timken customers have access to sales and service engineering support at their plants, and options for additional support from application engineers who specialize in a variety of industrial applications.



CORE CAPABILITIES

Timken has evolved from its early roots as a bearing producer to a supplier offering much more, including friction-management and power-transmission solutions that add value throughout the complete life cycle of a system. Our material

enhancements improve bearing life and can protect against debris and corrosion – two challenges encountered frequently in various industrial applications. Our precision manufacturing capabilities and commitment to quality ensure global consistency in design and manufacturing at every Timken facility. A global distribution network provides our customers with easy access to Timken products and services throughout the world.

We leverage these core capabilities as we work with original equipment manufacturers (OEM) and designers to integrate our technologies into equipment so that end users can enjoy the performance benefits of Timken products from the first day of operation. OEMs depend on Timken for our engineering expertise, manufacturing capabilities and emphasis on reliable performance.



PRODUCTS AND SERVICES

We offer equipment builders and operators one of the most extensive friction-management product and service portfolios in the industry.

We also strictly adhere to the Timken Quality Management System in every plant worldwide, so each bearing product meets the same high quality standards – no matter where in the world it is manufactured.

BEARINGS

Timken provides a broad range of bearing designs and configurations for use in steelmaking vessels, caster segments, work rolls, backup rolls, screwdown systems, mill drives, pinion stands, coilers, table rolls, and auxiliary equipment. Bearing types include:

- **Tapered roller bearings** – Tapered roller bearings are uniquely designed to manage both thrust and radial loads and are available in single- and multi-row designs with a wide range of assembly options. Our extensive offering of tapered roller bearing combinations provides equipment builders and operators simple, reliable and less costly design solutions.
- **Cylindrical roller bearings** – This design generally offers the highest possible radial load capacity for a given size compared to other roller bearing types. Single-row and double-row cylindrical roller bearings are ideal for many mill stand, gear drive and other auxiliary equipment applications, while four-row cylindrical roller bearings are used in roll neck applications. Timken offers both single and multi-row cylindrical roller bearing. Custom designs are available upon request for specific applications.
- **Spherical roller bearings** – Spherical roller bearings offer high radial and moderate thrust capacity together with maximum static and dynamic misalignment capability. Timken® spherical roller bearings provide high-static load

capacity and advanced geometry that reduces friction and heat generation. These bearings are available in a range of dimensional stability configurations to suit elevated operating temperatures.

- **Thrust roller bearings** – Thrust roller bearings for rolling mill applications are available in cylindrical, spherical and tapered designs. Thrust bearings are ideal for applications experiencing heavy axial loads, such as mill stands, screw-down systems and piercing mills.



- **Ball bearings** - Ball bearings are used extensively in auxiliary applications that have light loads and/or high-speed conditions. Timken offers a range of radial, thrust and angular contact ball bearings in both metric and inch sizes. Please contact your Timken engineer for detailed information on these product ranges.
- **Housed units** - Timken® spherical roller bearing solid-block housed units process a unique cast-steel design that handles demanding conditions in metal industry applications. These solid-block housed units come in several styles and five advanced locking configurations. Timken spherical roller bearing solid-block housed units are designed for challenging circumstances. A full line of primary seals, covers and housings is available to find the right roller housed unit to fit your application. In case of high thrust loads, in excess of the spherical roller bearing carrying capabilities, the Timken® Type E is your recommended solution. Through our unique product design, we have optimized the core components so their performance is elevated to a level we consider the next generation of roller housed units. Application testing has shown that our Type E bearing yields a design life that is 55 percent higher than current industry leading designs which utilize standard Timken bearings. Timken also provides a broad range of SNT metric plummer blocks and the SAF inch pillow block line which include a wide range of sizes, housing designs, seals and accessories. The standard line of Timken split-block housings is constructed of cast iron and designed to protect bearings.

HIGH-PERFORMANCE BEARING SOLUTIONS

Timken provides a variety of high-performance bearing solutions, including Timken® AquaSpexx®, DuraSpexx® and thin dense chrome bearings for corrosion protection. Our debris-resistant bearings are ideal for contaminated and/or marginal lubrication conditions.

We also provide customized bearing solutions such as special race profiles to meet special application requirements.

In addition to component geometry and metallurgy, we find many ways to enhance bearing performance by applying unique surface finishes and special coatings on rollers, raceways and other functional surfaces. Engineered surfaces and topographical modifications reduce surface roughness to lower levels rather than what can be achieved through conventional grinding and honing methods. We also offer proprietary coatings that can create a surface up to four times harder than steel with twice the elasticity. For more information on Timken high-performance bearings and engineered surfaces, contact a Timken sales representative.



POWER TRANSMISSION COMPONENTS AND SYSTEMS

Timken offers an expanding range of power transmission components including seals, couplings and engineered chain.

Extreme temperatures and high contamination levels can disable your equipment and significantly lower productivity. Timken develops seals using advanced material and process solutions that help protect machinery and minimize plant downtime. We offer a comprehensive line of large-bore oil and grease seals, and metallic and non-metallic bearing isolators.

Timken® Quick-Flex® couplings are highly durable, yet need minimal maintenance. They are easy to install and require no lubrication. The couplings are designed to connect motors and gearboxes with other moving equipment with capacity to transmit the same or more torque than a gear coupling in the same dimensions. The Quick-Flex coupling's innovative design utilizes an advanced elastomeric element to transmit the torque and therefore eliminates any interference between coupling hubs which can damage equipment.

Timken manufactures precision roller chains that are designed to meet demanding steel industry applications. We build chains to precise specifications for strength and maximum wear life. The offering includes a complete line of roller chains, attachment chains and engineered conveyor chains.

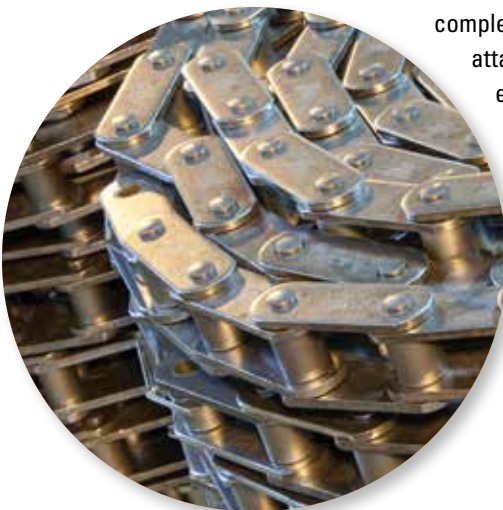

LUBRICATION

Timken® lubricants reduce friction, prevent wear and protect bearing surfaces from corrosion. We offer a wide selection of lubricants, including Timken® Mill Grease, which we formulated to perform in the difficult roll neck bearing environment. Timken® single- and multi-point lubricators and lubrication delivery devices help maintenance professionals simplify their lubrication practices, saving time and money.



CONDITION MONITORING

Powerful diagnostic tools from Timken are designed to detect potential bearing failure before it occurs. A variety of handheld devices and online options – including our ultra-accurate Online Intelligence System – lets you monitor bearing condition, lubrication quality and machine vibration (either periodically or continuously) for increased productivity, safety and peace of mind.



MAINTENANCE TOOLS

Timken® maintenance tools may extend bearing life by facilitating proper installation, removal and service. They also help simplify maintenance practices. We provide induction heaters, impact fitting tools, and hydraulic and mechanical pullers.

SERVICES

Used bearings and related components often can be returned to their original specifications with less time and costs than purchasing new. We offer complete remanufacture and reconditioning services for many components, including bearings, chocks, housings, rolls and more.

Our gearbox repair services are globally recognized for power transmission solutions in heavy industrial markets, repairing virtually any large gearbox make or model, with on-site emergency breakdown service available if needed.

Timken offers a full range of maintenance and reconditioning services through our remanufacturing and repair operations. Using these services can lead to improved plant efficiency and reduced overall production costs.

TRAINING

We offer industry-specific training programs designed for plant professionals, as well as on-site customized training to meet your specific needs. Our training programs are available at select locations around the world and cover every phase of bearing performance. Class time is balanced with extensive hands-on training and tours of Timken facilities.



HOW TO USE THIS CATALOG

We designed this catalog to help you find the Timken bearings best suited to your equipment needs and specifications.

The product tables list many of the bearing types that are specifically used in thrust positions. For other bearing types, please refer to the respective Timken product catalog reference.

Timken offers an extensive range of bearings and accessories in both imperial and metric sizes. For your convenience, size ranges are indicated in millimeters and inches. Contact your Timken engineer to learn more about our complete line for the special needs of your application.

This publication contains dimensions, tolerances and load ratings, as well as engineering sections describing mounting and fitting practices for shafts and housings, internal clearances, materials and other bearing features. It provides valuable assistance in the initial consideration of the type and characteristics of the bearings that may best suit your particular needs.

ISO and ANSI/ABMA, as used in this publication, refer to the International Organization for Standardization and the American National Standards Institute/American Bearing Manufacturers Association.



SHELF LIFE AND STORAGE OF GREASE-LUBRICATED BEARINGS AND COMPONENTS

To help you get the most value from our products, Timken provides guidelines for the shelf life of grease-lubricated ball and roller bearings, components and assemblies. Shelf life information is based on Timken and industry test data and experience.

SHELF LIFE

Shelf life should be distinguished from lubricated bearing/component design life as follows:

Shelf life of the grease-lubricated bearing/component represents the period of time prior to use or installation.

The shelf life is a portion of the anticipated aggregate design life. It is impossible to accurately predict design life due to variations in lubricant bleed rates, oil migration, operating conditions, installation conditions, temperature, humidity and extended storage.

Shelf life values, available from Timken, represent a maximum limit and assume adherence to the storage and handling guidelines suggested in this catalog or by a Timken associate. Deviation from the Timken storage and handling guidelines may reduce shelf life. Any specification or operating practice that defines a shorter shelf life should be used.

Timken cannot anticipate the performance of the grease lubricant after the bearing or component is installed or placed in service.

TIMKEN IS NOT RESPONSIBLE FOR THE SHELF LIFE OF ANY BEARING/COMPONENT LUBRICATED BY ANOTHER PARTY.

European REACH Compliance

Timken lubricants, greases and similar products sold in standalone containers or delivery systems are subject to the European REACH (Registration, Evaluation, Authorization and Restriction of CHemicals) directive. For import into the European Union, Timken can sell and provide only those lubricants and greases that are registered with ECHA (European CHemical Agency). For further information, please contact your Timken engineer.

STORAGE

Timken suggests the following storage guidelines for our finished products (bearings, components and assemblies, referred to as "products"):

- Unless directed otherwise by Timken, products should be kept in their original packaging until they are ready to be placed into service.
- Do not remove or alter any labels or stencil markings on the packaging.
- Products should be stored in such a way that the packaging is not pierced, crushed or otherwise damaged.
- After a product is removed from its packaging, it should be placed into service as soon as possible.



- When removing a product that is not individually packaged from a bulk pack container, the container should be resealed immediately after the product is removed.
- Do not use product that has exceeded its shelf life as defined in the Timken shelf life guidelines statement.
- The storage area temperature should be maintained between 0° C (32° F) and 40° C (104° F); temperature fluctuations should be minimized.
- The relative humidity should be maintained below 60 percent and the surfaces should be dry.
- The storage area should be kept free from airborne contaminants such as, but not limited to, dust, dirt, harmful vapors, etc.
- The storage area should be isolated from undue vibration.
- Extreme conditions of any kind should be avoided.

Due to the fact that Timken is not familiar with your particular storage conditions, we strongly suggest following these guidelines. However, you may be required by circumstances or applicable government requirements to adhere to stricter storage requirements.

Most bearing components typically ship protected with a corrosion-preventive compound that is not a lubricant. These components may be used in oil-lubricated applications without removal of the corrosion-preventive compound. When using some specialized grease lubrications, we advise you to remove the corrosion-preventive compound before packing the bearing components with suitable grease.

 **WARNING**

Failure to observe the following warnings could create a risk of death or serious injury.

Never spin a bearing with compressed air.
The components may be forcefully expelled.
Proper maintenance and handling practices are critical.
Always follow installation instructions and maintain proper lubrication.

NOTE

*Never use steam or hot water when cleaning the bearings because these methods can create rust or corrosion.
Never expose any surface of a bearing to the flame of a torch.
Do not heat bearing beyond 149° C (300° F)*

**WARNING**

Failure to observe the following warnings could create a risk of death or serious injury.

Proper maintenance and handling practices are critical. Always follow installation instructions and maintain proper lubrication.

Overheated bearings can ignite explosive atmospheres. Special care must be taken to properly select, install, maintain, and lubricate housed unit bearings that are used in or near atmospheres that may contain explosive levels of combustible gases or accumulations of dust such as from grain, coal, or other combustible materials.

If hammer and bar are used for installation or removal of a part, use a mild steel bar (e.g., 1010 or 1020 grade). Mild steel bars are less likely to cause release of high-speed fragments from the hammer, bar or the part being removed.

Warnings for this product line are in this catalog and posted on <http://www.timken.com/warnings>.

NOTE

Do not attempt to disassemble unitized bearings. Components may become damaged and affect the performance and service life of the bearing.

Do not mix components of matched assemblies. Mixing components can reduce the service life of the bearing.

NOT TO BE USED AS A DESIGN MANUAL.

This is not a manual for the selection of bearings for new applications. Whenever it is necessary to select

Timken bearings for new applications consult the Timken Engineering Manual (order no. 10424) or get in touch with the nearest office of The Timken Company.

DISCLAIMER

This catalog is provided solely to give you analysis tools and data to assist you in your product selection. Product performance is affected by many factors beyond the control of Timken.

Therefore, the suitability and feasibility of all product selection must be validated by you.

Timken products are sold subject to Timken's terms and conditions of sale, which include its limited warranty and remedy, which terms may be found at <http://www.timken.com/termsandconditionsofsale>. Please consult with your Timken engineer for more information and assistance.

Every reasonable effort has been made to ensure the accuracy of the information in this writing, but no liability is accepted for errors, omissions or for any other reason.

COMPLIANCE

To view the complete engineering catalog, please visit www.timken.com. To order the catalog, please contact your Timken engineer and request a copy of the Timken Engineering Manual (order number 10424).

European REACH compliance Timken-branded lubricants, greases and similar products sold in stand-alone containers or delivery systems are subject to the European REACH (Registration, Evaluation, Authorization and Restriction of CHemicals) directive. For import into the European Union, Timken can sell and provide only those lubricants and greases that are registered with ECHA (European CHemical Agency). For further information, please contact your Timken engineer.

The Timken Company products shown in this catalog may be directly, or indirectly subject to a number of regulatory standards and directives originating from authorities in the USA, European Union, and around the world, including: REACH (EC 1907/2006, RoHS (2011/65/EU), ATEX (94/9/EC), 'CE' MARKING (93/68/EEC), CONFLICT MINERALS (Section 1502 of the Dodd-Frank Wall Street Reform and Consumer Protection Act).

For any questions or concerns regarding the compliancy or applicability of Timken products to these, or other unspecified standards, please contact your Timken sales engineer or customer services representative.

Updates are made periodically to this catalog. Visit www.timken.com for the most recent version of the Timken Thrust Bearing Catalog.

ENGINEERING

This engineering section is not intended to be comprehensive, but does serve as a useful guide in thrust bearing selection. To view the complete engineering catalog, please visit www.timken.com. To order the catalog, please contact your Timken engineer and request a copy of the Timken Engineering Manual (order no.10424).

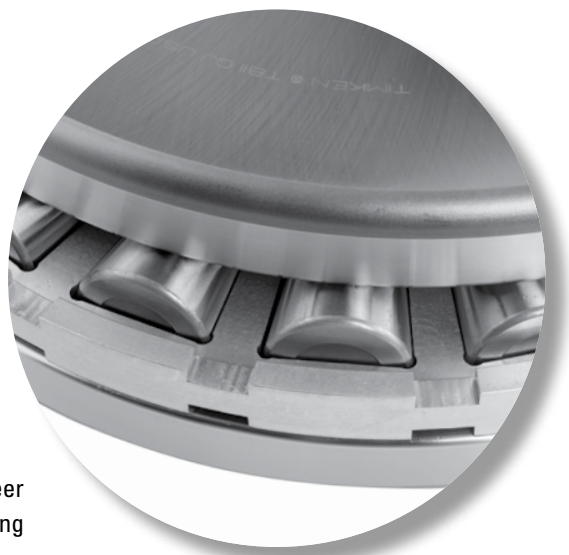

The following topics are covered within this engineering section:

Thrust Bearing Types	14
Bearing Reactions	20
Bearing Ratings	22
System Life and Weighted Average Load and Life	28
Bearing Tolerances, Metric and Inch Systems	29
Mounting Design, Fitting Practice and Setting	37
Bearing Operation	51
Lubrication	55



To view more Timken catalogs, go to www.timken.com/catalogs for interactive versions, or to download a catalog app for your smart phone or mobile device scan the QR code or go to timkencatalogs.squawqr.com.

THRUST BEARING TYPES

Standard types of thrust bearings manufactured by Timken include:

TVL – Single-row angular contact thrust ball bearing.

DTVL – Double-row (two direction) angular contact thrust ball bearing.

TP – Thrust cylindrical roller bearing.

TPS – Self-aligning thrust cylindrical roller bearing.

TSR – Thrust spherical roller bearing.

TTHD – Heavy-duty thrust tapered roller bearing with two tapered raceways. Variants include:

- **TTHDSX** – where one tapered raceway has a convex outer surface for static alignment (SX).
- **TTHDSV** – where one tapered raceway has a concave outer surface for static alignment (SV).

TTHDFL – Heavy-duty thrust tapered roller bearing having one flat and one tapered raceway. Variants include:

- **TTHDFLSA** – where the flat raceway is made of two self-aligning washers (SA).
- **TTHDFLSX** – where the tapered raceway has a convex outer surface for static alignment (SX).
- **TTHDFLSV** – where the tapered raceway has a concave outer surface for static alignment (SV).

TTSP – Steering pivot thrust tapered roller bearing, off-apex design.

TTC – Steering pivot thrust tapered roller bearing, full complement (cageless).

TTD – Double-acting thrust tapered roller bearing.

TXR – Crossed roller bearing.

Each type is designed to take thrust loads. Types TVL, DTVL, TSR and TXR can accommodate radial loads as well. All types reflect advanced design concepts, with large rolling elements for maximum capacity. For some thrust roller bearings, controlled-contour rollers are used to ensure uniform, full-length contact between rollers and raceways resulting in maximum capacity.

Thrust bearings should operate under continuous load for satisfactory performance.

ANGULAR CONTACT THRUST BALL BEARINGS

Thrust ball bearings are used for lighter loads and higher speeds than thrust roller bearings.

TVL

Type TVL is a separable angular contact ball bearing primarily designed for unidirectional thrust loads. The angular contact design, however, will accommodate combined radial and thrust loads since the loads are transmitted angularly through the balls.

The bearing has two hardened and ground steel rings with ball grooves and a one-piece brass cage that spaces the ball complement. The larger ring is called the outer ring, and the smaller the inner ring. Timken standard tolerances for type TVL bearings are equivalent to ABEC 1 where applicable, but higher grades of precision are available.

Usually the inner ring is the rotating member and is shaft mounted. The outer ring is normally stationary and should be mounted with O.D. clearance to allow the bearing to assume its proper operating position. If combined loads exist, the outer ring must be radially located in the housing.

Type TVL bearings should always be operated under thrust load. Normally, this presents no problem as the bearing is usually applied on vertical shafts in oil field rotary tables and machine tool indexing tables. If constant thrust load is not present, it should be imposed by springs or other built-in devices.

Low friction, cool running and quiet operation are advantages of TVL bearings, which may be operated at relatively high speeds. TVL bearings also are less sensitive to misalignment than other types of rigid thrust bearings.

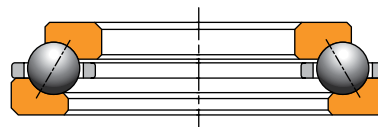

Fig. 1. Type TVL.

DTVL

Type DTVL is similar in design to TVL except that the DTVL has an additional ring and ball complement permitting it to carry moderate thrust in one direction and light thrust in the other direction.



Fig. 2. Type DTVL.

THRUST CYLINDRICAL ROLLER BEARINGS

Thrust cylindrical roller bearings are designed to operate under heavy thrust loads at moderate speeds. Standard versions of these bearings can be operated at peripheral bearing O.D. speeds up to approximately 15 m/s (3000 fpm). Higher operating speeds can be attained with the incorporation of special design features. Consult your Timken engineer for these applications.

For applications where thrust loads are high, lubricants with extreme-pressure (EP) additives should be used. The preferred inlet location for the lubricant is at the bearing bore as centrifugal force will cause the lubricant to distribute radially toward the rollers.

Two types of thrust cylindrical roller bearings, TP and TPS, are available.

TP

Type TP thrust cylindrical roller bearings have two hardened and ground raceways and a window-type steel cage which retains one or more profiled rollers per pocket. When multiple rollers are used in each pocket, they are different lengths and are placed in staggered position relative to rollers in adjacent pockets to create overlapping roller paths. This minimizes wear of the raceways and therefore increases bearing life.

Because of the simplicity of their design, type TP bearings are economical. Shaft and housing seats must be square to the axis of rotation to prevent initial misalignment problems.

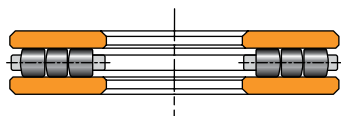

Fig. 3. Type TP.

TPS

Type TPS bearings have a lower race comprised of two rings, with the contacting faces spherically ground to provide an aligning feature. As a result, the TPS bearing is self-adjusting to static misalignment. Its use is not, however, suggested for operating conditions where alignment is continuously changing (dynamic misalignment).



Fig. 4. Type TPS.

THRUST SPHERICAL ROLLER BEARINGS

Thrust spherical roller bearings are designed with spherically contoured rollers arranged in a steep angular configuration to achieve a high-thrust capacity with low friction and continuous roller alignment. In addition to thrust loads, they can accommodate moderate radial loads. Maximum allowable bearing O.D. speeds are typically in the 25-30 m/s (5000-6000 fpm) range, depending on size and operating temperature. They represent a combination of radial and thrust bearings, designed to operate even if shaft and housing are, or become, misaligned under load. Thrust spherical roller bearings are preferred when conditions include heavy loads, difficulties in establishing or maintaining housing alignment or when shaft deflection can be expected.

Shaft deflections and housing distortions caused by shock or heavy loads (which lead to misalignment) are compensated for by the internal self-alignment of the bearing elements during operation. Elevated edge stress on rollers, a condition that limits service life on other types of bearings, does not develop in thrust spherical roller bearings.

The thrust spherical roller bearing achieves high-thrust capacity and allows axial misalignment between the inner ring and the outer ring of up to $\pm 2.5^\circ$. Timken thrust spherical roller bearings are now offered exclusively with maximum capacity E-type cage construction (EM-finger type machined bronze cage, EJ-window type steel cage). Those having a bore size less than 320 mm (12.598 in.) are typically offered as TSR-EJ designs, while those with larger bores are typically designated as TSR-EM.

The inherent compensation for misalignment, provided by the spherical roller bearings, offers the designer the opportunity to use weldments for housing frames instead of complex castings. This eliminates high-cost machining operations. When castings are preferred, bore alignment is less critical if spherical roller bearings are specified. Should extreme conditions of loading and/or speed under misalignment be anticipated, contact your Timken engineer before ordering.

TSR-EJ

TSR-EJ bearings use window-type steel cages that wrap around an extension on the inner race to provide a retention means for the cage and rollers. This construction unitizes the cage and roller assembly with the inner ring, and hence simplifies bearing mounting and handling.

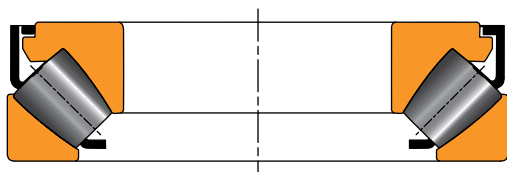

Fig. 5. Type TSR-EJ.

TSR-EM

TSR-EM bearings use finger-type brass cages. The brass cage design provides improved lubrication characteristics over a steel cage and in some cases allows for an additional roller, resulting in higher dynamic load rating. TSR-EM bearings have a roller retention ring, also known as the cage band, mounted and secured to the inner ring to retain the rollers.



Fig. 6. Type TSR-EM.

THRUST TAPERED ROLLER BEARINGS

Thrust tapered roller bearings come in various types and within each type, there are typically several variations. The variation is denoted by a suffix in the bearing type as noted below.

D	Double acting
HD	Heavy duty
FL	Flat or freelateral
K	Keyway
SA	Spherical alignment
SV	Spherical concave ring outer profile
SX	Spherical convex ring outer profile
W	Oil slots

TTHD, TTHDSX AND TTHDSV

Type TTHD heavy-duty thrust tapered roller bearings have an identical pair of hardened and ground steel rings with tapered raceways, controlled-contour tapered rollers and typically a cage to equally space the rollers. The raceways of both rings and the tapered rollers have a common apex at the bearing center, providing true rolling motion. As a result, maximum speed ratings for TTHD bearings are higher than those of most other thrust bearing types. Type TTHD bearings also can be supplied with a full complement of rollers for low-speed, heavily loaded applications. Full-complement designs offer the highest capacity at somewhat reduced speed capability. Applications for full-complement bearings should be reviewed by your Timken engineer for help in selection of the proper bearing.

TTHD bearings are well-suited for applications where high thrust and/or heavy shock loads are applied and radial positioning is critical. Typical applications for TTHD bearings include crane hooks, oil well swivels, pulp refiners, extruders and piercing mill thrust blocks.

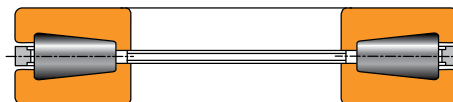

Fig. 7. Type TTHD.

Type TTHDSX and TTHDSV thrust tapered roller bearings have tapered raceways and a full complement of rollers. They are commonly known as screw down bearings in the metals industry. Outer raceways for TTHDSX and TTHDSV bearings have convex and concave outer surfaces, respectively, for the purpose of set-up alignment. They do not have a conventional bore, but are provided with center inserts for attachment purposes as well as lifting.

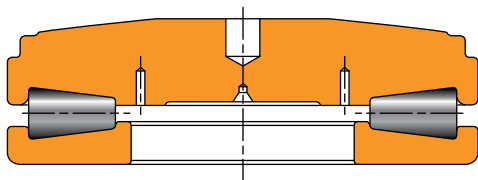

Fig. 8. Type TTHDSX.

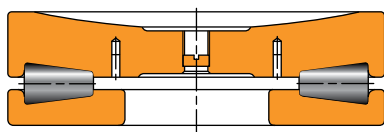

Fig. 9. Type TTHDSV.

TTHDFL, TTHDFLSA, TTHDFLSX AND TTHDFLSV

Types TTHDFL, TTHDFLSA, TTHDFLSX and TTHDFLSV heavy-duty thrust bearings have one tapered raceway, one flat raceway and controlled-contour rollers to optimize stress distribution over the contact surface. These designs combine features offering the highest possible capacity of any thrust bearing of their size and providing superior static thrust capacity. The designs were originally developed for metal scw down rolling mill (breaker block) applications. They also are used in heavily loaded extruders, cone crushers and other applications where a wide range of operating conditions are found.

Type TTHDFL bearings typically use brass cages for smaller sizes and pin-type cages for larger sizes. The pin-type cage includes hardened pins which are inserted through the rollers, allowing closer roller spacing to maximize capacity. Smaller sizes typically use pocket-type machined brass cages. Both the brass and pin-type cages are designed to permit a full flow of lubricant to all critical surfaces, providing cooler operation.

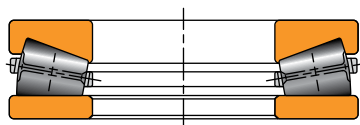

Fig. 10. Type TTHDFL.

Type TTHDFLSA bearings are similar to TTHDFL, except that the bottom race assembly is comprised of two rings, with the contacting faces spherically ground. As a result, the TTHDFLSA bearing is self-adjusting to static misalignment. It should not be used for operating conditions where alignment is continuously changing (dynamic misalignment).

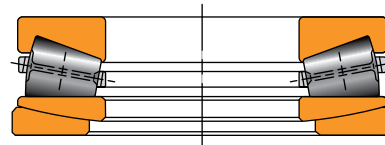

Fig. 11. Type TTHDFLSA.

Types TTHDFLSX and TTHDFLSV are full-complement designs having one raceway with either a convex or concave outer surface for the purpose of static alignment. They are commonly known as screw down bearings in the metals industry. They do not have a conventional bore, but are provided with center inserts for lifting and assembly. The full-complement design offers the highest capacity, but a reduced speed capability compared to other thrust bearings having a flat raceway.

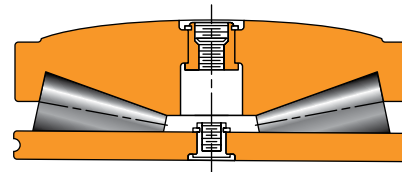

Fig. 12. Type TTHDFLSX.

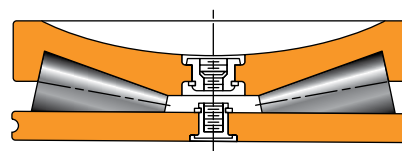

Fig. 13. Type TTHDFLSV.

TTSP, TTSPS AND TTSP L

Types TTSP, TTSPS and TTSP L thrust bearings consist of two tapered races, rollers, cage and outside retainer. The retainer holds the assembly together for shipping and installation. The raceways are off-apex, which means they do not provide true rolling motion. These thrust bearing types are used extensively in oscillating steering pivot applications.



Fig. 14.
Type TTSP.

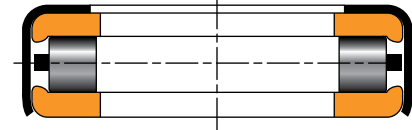

Fig. 15.
Type TTSPS.

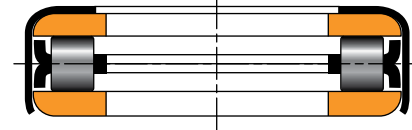

Fig. 16.
Type TTSP L.

TTC, TTCS AND TTCL

Types TTC, TTCS and TTCL are cageless thrust bearings that consist of two tapered thrust raceways, a full complement of tapered rollers and an outside retainer. The outside retainer holds the assembly together for shipping and installation. These types are specifically designed for slow speed and oscillating applications and are identical with the exception of retainer construction.

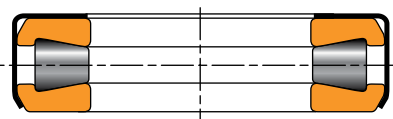

Fig. 17. Type TTC.

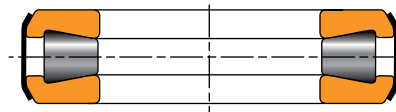

Fig. 18. Type TTCS.



Fig. 19. Type TTCL.

TTD

Type TTD bearings are double-acting thrust tapered roller bearings that can take thrust loads in both axial directions. The inner ring is one piece having two separate raceways, one on each of the outer surfaces. These raceways can be either flat or tapered. For a flat inner raceway, the mating outer ring raceway is tapered and for a tapered inner raceway, the outer ring is flat. The outer rings and cage roller assembly are separable and are not interchangeable. Variations of the TTD bearing include the following features:

- TTDW with oil slots.
- TTDWK with oil slots and keyway.
- TTDK keyway (see variants in figs. 21-22).
- TTDFL with flat outer ring raceway.
- TTDFLK with flat inner ring raceway and keyway.

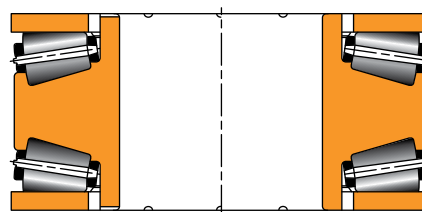

Fig. 20. Type TTDW.

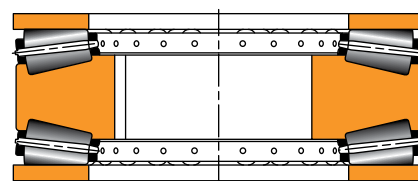

Fig. 21. Type TTDK 1.

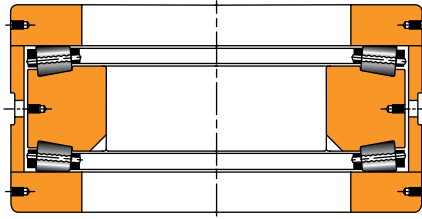

Fig. 22. Type TTDK 2.

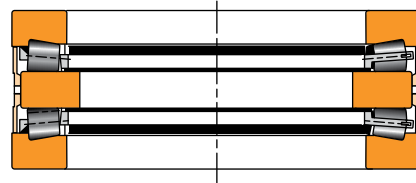

Fig. 23. Type TTDFLK.

TXR – CROSSED ROLLER BEARINGS

A crossed roller bearing is two sets of bearing rings and rollers brought together at right angles with alternate rollers facing opposite directions. TXR bearings have a section height not much greater than that of a TS bearing. The steep angle, tapered geometry of the bearing results in a total effective bearing spread many times greater than the width of the bearing itself. This type of bearing offers a high resistance to overturning moments.

The normal design of the bearing is type TXRD0, which has a double outer ring and two inner rings, with rollers spaced by polymer cages. Another design, Type TXRDI, has a double inner-ring and two outer rings. Crossed roller bearings are manufactured in precision classes. The crossed roller bearing is ideal for machine tool applications such as vertical boring mills, grinding machines, and other similar applications.



Fig. 24. Type TXR crossed roller bearings.

BEARING REACTIONS

DYNAMIC EQUIVALENT THRUST LOAD (P_a)

To calculate the fatigue life of a thrust bearing, it is necessary to calculate a dynamic equivalent thrust load, designated as P_a . The dynamic equivalent thrust load is defined as the single thrust load that, if applied to the bearing, will result in the same life as the combined radial and thrust loading under which the bearing operates. For thrust ball, thrust spherical and thrust tapered roller bearings, the existence of radial loads introduces complex load calculations that must be carefully considered. If the radial load (F_r) is zero, the dynamic equivalent thrust load will be equal to the applied thrust load (F_a).

THRUST BALL, CYLINDRICAL AND TAPERED ROLLER BEARINGS

Thrust cylindrical roller bearings, as well as most thrust ball and thrust tapered roller bearings, are designed to carry thrust load only. The dynamic equivalent thrust load is equal to the applied thrust load (F_a) for these pure thrust applications. For thrust ball and thrust tapered roller bearing applications where radial load is applied, load calculations become much more complex. Please consult your Timken engineer for a review of bearing selection and application.

ANGULAR CONTACT THRUST BALL BEARINGS

For angular contact thrust ball bearings, the dynamic equivalent thrust load is determined by:

$$P_a = X F_r + Y F_a$$

For standard TVL and DTVL bearings having a 50° contact angle, $X = 0.76$ and $Y = 1.00$. Minimum F_a/F_r ratio to maintain proper operation for these applications is 1.56.

THRUST SPHERICAL ROLLER BEARINGS

Thrust spherical roller bearing dynamic loads are determined by:

$$P_a = 1.2F_r + F_a$$

Radial load (F_r) of a thrust spherical roller bearing is proportional to the applied axial load (F_a) such that $F_r \leq 0.55 F_a$. The steep roller angle induces a thrust load ($F_{ai} = 1.2F_r$) when a radial load is applied. This thrust load must be resisted by another thrust bearing on the shaft or by an axial load greater than F_{ai} .

STATIC AXIAL EQUIVALENT LOADS

To compare the load on a non-rotating bearing with the basic static capacity, it is necessary to determine the static equivalent load. In the case of thrust bearings, the static equivalent thrust load is used. The static axial equivalent load is defined as the pure thrust load that produces the same contact pressure in the center of the most heavily stressed rolling element as the actual combined load. The static axial equivalent load is dependent on the bearing type selected. For bearings such as thrust cylindrical roller bearings and most thrust tapered roller bearings that are designed to accommodate thrust loading only, the static axial equivalent load is equal to the applied load. For thrust tapered roller bearings where a radial load or moment is applied, please consult your Timken engineer.

THRUST BALL, CYLINDRICAL AND TAPERED ROLLER BEARINGS

Thrust cylindrical roller bearings, as well as most thrust ball and thrust tapered roller bearings, are designed to carry thrust load only. The static axial equivalent load is equal to the applied thrust load for these pure thrust applications. For thrust ball and thrust tapered roller bearing applications where radial load is applied, load calculations become much more complex. Please consult your Timken engineer for these applications.

ANGULAR CONTACT THRUST BALL BEARINGS

Angular contact thrust ball bearings use the same equation for equivalent static and dynamic loading.

$$P_{oa} = X_o F_r + Y_o F_a$$

For standard TVL and DVL bearings having a 50° contact angle, $X = 0.76$ and $Y = 1.00$.

THRUST SPHERICAL ROLLER BEARINGS

The following equation is used for thrust spherical roller bearings:

$$P_{oa} = F_a + 2.7 F_r$$

Thrust spherical roller bearings require a minimum thrust load for proper operation. P_{oa} should not be greater than $0.5 C_{oa}$. If conditions exceed this, consult your Timken engineer.

MINIMUM BEARING LOAD

THRUST SPHERICAL ROLLER BEARINGS

Centrifugal force in thrust spherical roller bearings tends to propel the rollers outward. The bearing geometry converts this force to induced thrust component, which must be overcome by an axial load. This induced thrust (F_{ac}) is given by:

$$F_{ac} = Kc n^2 \times 10^{-5} \text{ (lbf per RPM)}$$

Kc = centrifugal force constant found in product tables pages 87-91

The minimum required working thrust load on a thrust spherical roller bearing ($F_{a \text{ min}}$) is then computed by:

$$F_{a \text{ min}} = 1.2 F_r + F_{ac} \geq C_{0a}/1000 \text{ (lbf)}$$

In addition to meeting the above calculated value, the minimum required working thrust load ($F_{a \text{ min}}$) should be equal to or greater than 0.1 percent of the static thrust load rating (C_{0a}).

BEARING RATINGS

There are two fundamental load ratings for bearings, a dynamic load rating and a static load rating. The dynamic load rating is used to estimate the life of a rotating bearing. Static load ratings are used to determine the maximum permissible load that can be applied to a non-rotating bearing.

DYNAMIC LOAD RATING

Published dynamic load ratings for Timken bearings are typically based on a rated life of one million revolutions. This rating, designated as C , is defined as the radial load under which a population of bearings will achieve an L_{10} life of one million revolutions. For Timken tapered roller bearings, the dynamic load rating is more commonly based on a rated life of 90 million revolutions, with the designation of C_{90} . This rating is the radial load under which a population of bearings will achieve an L_{10} life of 90 million revolutions. For tapered roller bearings, the dynamic thrust rating also is published and is designated as C_{a90} . The C_{a90} rating is the thrust load under which a population of bearings will achieve an L_{10} life of 90 million revolutions. The dynamic load rating of a bearing is a function of material cleanliness as well as the internal bearing geometry, which includes raceway angles, contact length between rolling elements and raceways, and the number and size of rolling elements.

STATIC LOAD RATING

The basic static radial load rating and thrust load rating for Timken bearings are based on a maximum contact stress within a non-rotating bearing of 4000 MPa (580 ksi) for roller bearings and 4200 MPa (609 ksi) for ball bearings, at the center of contact on the most heavily loaded rolling element.

The 4000 MPa (580 ksi) or 4200 MPa (609 ksi) stress levels may cause visible light Brinell marks on the bearing raceways. This degree of marking will not have a measurable effect on fatigue life when the bearing is subsequently rotating under a lower application load. If sound, vibration or torque is critical, or if a pronounced shock load is present, a lower load limit should be applied. For more information on selecting a bearing for static

load conditions, consult your Timken engineer.

BEARING LIFE

Many different performance criteria exist that dictate how a bearing should be selected. These include bearing fatigue life, rotational precision, power requirements, temperature limits, speed capabilities, sound, etc. This section deals primarily with bearing life as related to material-associated fatigue. Bearing life is defined as the length of time, or number of revolutions, until a fatigue spall of 6 mm² (0.01 in.²) develops. Since fatigue is a statistical phenomenon, the life of an individual bearing is impossible to predetermine precisely. Bearings that may appear to be identical can exhibit considerable life scatter when tested under identical conditions. Thus it is necessary to base life predictions on a statistical evaluation of a large number of bearings operating under similar conditions. The Weibull distribution function is the accepted standard for predicting the life of a population of bearings at any given reliability level.

RATING LIFE

Rating life, (L_{10}), is the life that 90 percent of a group of apparently identical bearings will complete or exceed before a fatigue spall develops. The L_{10} life also is associated with 90 percent reliability for a single bearing under a certain load.

BEARING LIFE EQUATIONS

Traditionally, the L_{10} life has been calculated as follows for bearings under radial or combined loading, where the dynamic equivalent radial load, P_r , has been determined and the dynamic load rating is based on one million cycles:

$$L_{10} = \left(\frac{C}{P_r} \right)^e (1 \times 10^6) \text{ revolutions}$$

$$\text{or } L_{10} = \left(\frac{C}{P_r} \right)^e \left(\frac{1 \times 10^6}{60n} \right) \text{ hours}$$

For thrust bearings, the above equations change to the following:

$$L_{10} = \left(\frac{C_a}{P_a} \right)^e (1 \times 10^6) \text{ revolutions}$$

$$\text{or } L_{10} = \left(\frac{C_a}{P_a} \right)^e \left(\frac{1 \times 10^6}{60n} \right) \text{ hours}$$

$$e = 3 \text{ for ball bearings}$$

$$= 10/3 \text{ for tapered, cylindrical and spherical roller bearings}$$

Tapered roller bearings typically use a dynamic load rating based on 90 million cycles, denoted as C_{90} , changing the equations as follows:

$$L_{10} = \left(\frac{C_{90}}{P_r} \right)^{10/3} (90 \times 10^6) \text{ revolutions}$$

or $L_{10} = \left(\frac{C_{90}}{P_r} \right)^{10/3} \left(\frac{90 \times 10^6}{60n} \right) \text{ hours}$

and $L_{10} = \left(\frac{C_{a90}}{P_a} \right)^{10/3} (90 \times 10^6) \text{ revolutions}$

or $L_{10} = \left(\frac{C_{a90}}{P_a} \right)^{10/3} \frac{90 \times 10^6}{60n} \text{ hours}$

The traditional form of the equations based on dynamic load ratings of one million cycles is most common and will, therefore, be used throughout the rest of this section. The dynamic equivalent load equations and the life adjustment factors defined in subsequent sections are applicable to all forms of the life equation.

With increased emphasis on the relationship between the reference conditions and the actual environment in which the bearing operates in the machine, the traditional life equations have been expanded to include certain additional variables or factors that affect bearing performance. The approach whereby these factors are considered in the bearing analysis and selection has been termed Bearing Systems Analysis (BSA). For thrust bearings, these factors are currently only applied to thrust tapered and thrust spherical roller bearings. The ABMA expanded bearing life equation is:

$$L_{na} = a_1 a_2 a_3 L_{10}$$

The Timken expanded bearing life equation is:

$$L_{na} = a_1 a_2 a_{3d} a_{3l} a_{3m} a_{3p} \left(\frac{C}{P_r} \right)^e (1 \times 10^6) \text{ revolutions}$$

Where $e = 3$ for ball bearings
 $= 10/3$ for tapered, cylindrical and spherical roller bearings

RELIABILITY LIFE FACTOR (a_1)

Reliability, in the context of bearing life for a group of apparently identical bearings operating under the same conditions, is the percentage of the group that is expected to attain or exceed a specified life. The reliability of an individual bearing is the probability that the bearing will attain or exceed a specified life.

The reliability life adjustment factor is:

$$a_1 = 4.26 \left(\ln \frac{100}{R} \right)^{2/3} + 0.05$$

\ln = natural logarithm (base e)

To adjust the calculated L_{10} life for reliability, multiply by the a_1 factor. If 90 (90 percent reliability) is substituted for R in the above equation, $a_1 = 1$. For $R = 99$ (99 percent reliability), $a_1 = 0.25$. The table below lists the reliability factors for commonly used reliability values.

TABLE 1. RELIABILITY FACTORS

R (percent)	L_n	a_1
90	L_{10}	1.00
95	L_5	0.64
96	L_4	0.55
97	L_3	0.47
98	L_2	0.37
99	L_1	0.25
99.5	$L_{0.5}$	0.175
99.9	$L_{0.1}$	0.093

NOTE: The equation for reliability adjustment assumes there is a short minimum life below which the probability of bearing damage is minimal (e.g., zero probability of bearing damage producing a short life). Extensive bearing fatigue life testing has shown the minimum life, below which the probability of bearing damage is negligible, to be larger than predicted using the above adjustment factor. For a more accurate prediction of bearing lives at high levels of reliability, consult your Timken engineer.

MATERIAL LIFE FACTOR (a_2)

The life adjustment factor for bearing material, a_2 , for standard Timken bearings manufactured from bearing quality steel is 1.0. Bearings also are manufactured from premium steels, containing fewer and smaller inclusion impurities than standard steels and providing the benefit of extending bearing fatigue life (e.g., DuraSpexx® bearing). Application of the material life factor requires that fatigue life is limited by nonmetallic inclusions, that contact stresses are approximately less than 2400 MPa (350 ksi), and adequate lubrication is provided. It is important to note that improvements in material cannot offset poor lubrication in an operating bearing system. Consult your Timken engineer for applicability of the material factor.

DEBRIS LIFE FACTOR (a_{3d})

Debris within a lubrication system reduces the life of a roller bearing by creating indentations on the contacting surfaces, leading to stress risers. The Timken life rating equations were developed based on test data obtained with 40 μm oil filtration, and measured ISO cleanliness levels of approximately 15/12, which is typical of cleanliness levels found in normal industrial machinery. When more or less debris is present within the system, the fatigue life predictions can be adjusted according to the measured or expected ISO lubricant cleanliness level to more accurately reflect the expected bearing performance.

A more accurate option for predicting bearing life in a debris environment is to perform a Debris Signature Analysis™. The Debris Signature Analysis is a process for determining the effects of the actual debris present in your system on the bearing performance. The typical way in which this occurs is through measurements of dented/bruised surfaces on actual bearings run in a given application. This type of analysis can be beneficial because different types of debris cause differing levels of performance degradation. Soft, ductile particles can cause differing levels of performance degradation than hard, brittle particles. Hard, ductile particles are typically most detrimental to bearing life. Brittle particles can break down, thus not affecting performance to as large of a degree as hard, ductile particles. For more information on Debris Signature Analysis or the availability of debris-resistant bearings for your application, consult your Timken engineer.

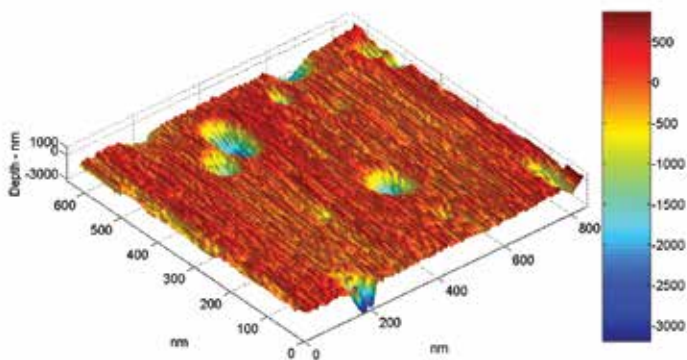

Fig. 25. Surface map of a bearing raceway with debris denting.

LUBRICATION LIFE FACTOR (a_{3l})

The influence of lubrication film on bearing performance is related to the reduction or prevention of asperity (metal-metal) contact between the bearing surfaces. Extensive testing has been done at our technology centers to quantify the effects of the lubrication-related parameters on bearing life. It has been found that the roller and raceway surface finish, relative to lubricant film thickness, has the most notable effect on improving bearing performance. Factors such as bearing geometry, material, loads and load zones also play an important role in bearing performance.

The following equation provides a method to calculate the lubrication factor for a more accurate prediction of the influence of lubrication on bearing life (L_{10a}):

$$a_{3l} = C_g C_l C_s C_v C_{gr}$$

The a_{3l} maximum is 2.88 for all bearings. The a_{3l} minimum is 0.200 for case-carburized bearings and 0.126 for through-hardened bearings. A lubricant contamination factor is not included in the lubrication factor because Timken endurance tests are typically run with a 40 μm filter to provide a realistic level of lubricant cleanness for most applications.

Geometry factor (C_g)

C_g is given for most part numbers that are available in the bearing catalogs on www.timken.com. The geometry factor also includes the material effects and load zone considerations for non-tapered roller bearings, as these also are inherent to the bearing design. However, it should be noted that the primary effect of the load zone is on roller load distributions and contact stresses within the bearing, which are not quantified within the lubrication factor. Refer to the previous section Load Zone Life Factor (a_{3k}) for more information.

The geometry factor (C_g) is not applicable to our DuraSpexx™ product. For more information on our DuraSpexx product, consult your Timken engineer.

Load factor (C_l)

The C_l factor can be obtained from fig. 26. Note that the factor is different based on the type of bearing utilized. P_r is the equivalent load applied to the bearing in Newtons and is determined in the Dynamic Equivalent Bearing Loads (P_r) section.

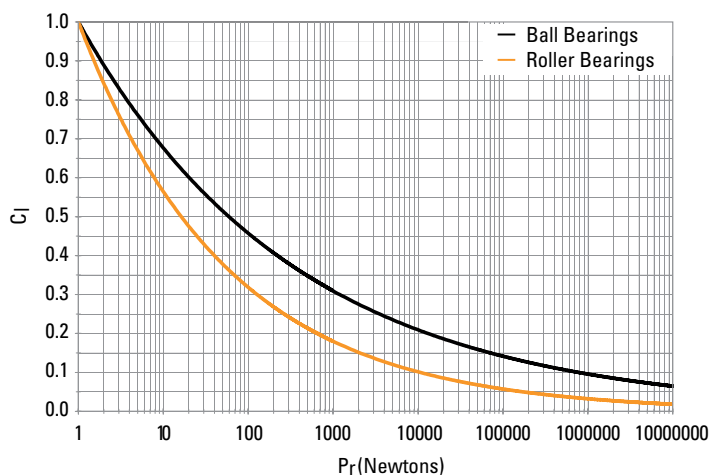

Fig. 26. Load factor (C_l) vs. dynamic equivalent bearing load (P_r).

Speed factor (C_s)

C_s can be determined from fig. 27, where rev/min (RPM) is the rotational speed of the inner ring relative to the outer ring.

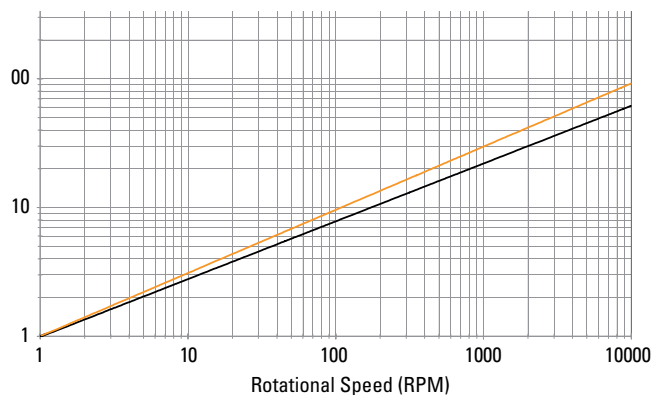

Fig. 27. Speed factor (C_s) vs. rotational speed.

Viscosity factor (C_v)

The lubricant kinematic viscosity (centistokes [cSt]) is taken at the operating temperature of the bearing. The operating viscosity can be estimated by fig. 28. The viscosity factor (C_v) can then be determined from figs. 28 and 29 shown here.

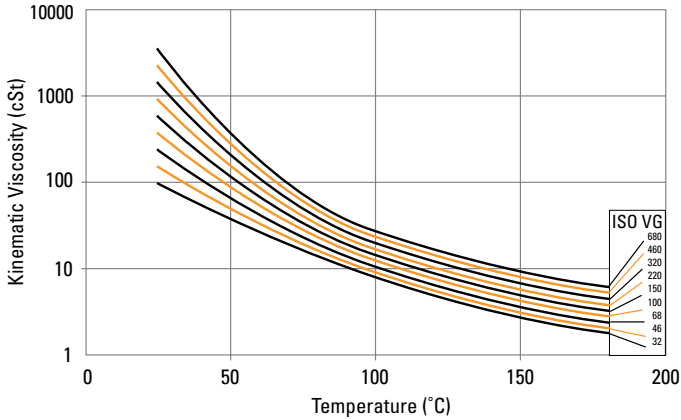

Fig. 28. Temperature vs. kinematic viscosity.

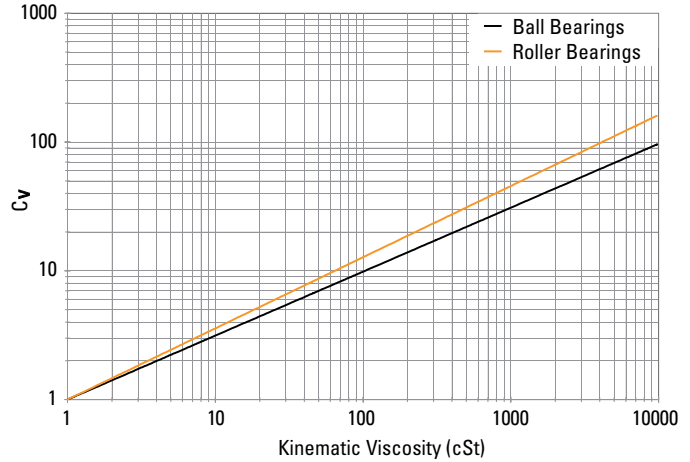

Fig. 29. Viscosity factor (C_v) vs. kinematic viscosity.

LOW-LOAD LIFE FACTOR (a_{3p})

Bearing life tests show greatly extended bearing fatigue life performance is achievable when the bearing contact stresses are low and the lubricant film is sufficient to fully separate the micro-scale textures of the contacting surfaces. Mating the test data with sophisticated computer programs for predicting bearing performance, Timken engineers developed a low-load factor to predict the life increase expected when operating under low-bearing loads. Fig. 30 shows the low-load factor (a_{3p}) as a function of the lubricant life factor (a_{3l}) and the ratio of bearing dynamic rating to the bearing equivalent load.

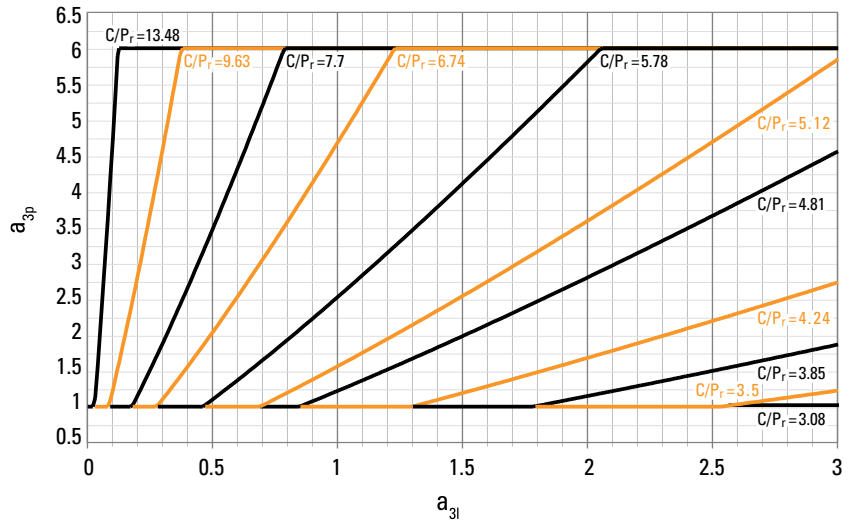

Fig. 30. Low-load life adjustment factor.

GREASE LUBRICATION FACTOR (C_{gr})

Over time, grease degradation causes a reduction in lubricant film thickness. Consequently, a reduction factor (C_{gr}) should be used to adjust for this effect.

$$C_{gr} = 0.79$$

MISALIGNMENT LIFE FACTOR (a_{3m})

Accurate alignment of the shaft relative to the housing is critical for bearing performance. As misalignment increases under moderate to heavy loads, high contact stresses can be generated at the edges of contact between the raceway and rolling element. Special profiling of the raceway or rolling element can, in most cases, offset the effects of misalignment as shown in fig. 31. This figure shows the roller-to-inner ring contact stress of a tapered roller bearing under a misaligned condition with and without special profiling. The profiling significantly reduces the edge stress, resulting in improved bearing performance. The misalignment factor takes into account the effects of profiling on bearing life.

The misalignment factor for thrust spherical roller bearings is 1.0 due to their self-aligning capabilities. The allowable misalignment of a thrust spherical roller bearing is ± 2.5 degrees. Life will be reduced if these limits are exceeded. For misalignment factors for other thrust bearing types, contact your Timken engineer.

Performance of all Timken bearings under various levels of misalignment and radial and axial load can be predicted using sophisticated computer programs. Using these programs, Timken engineers can design special bearing-contact profiles to accommodate the conditions of radial load, axial load and/or bearing misalignment in your application. Consult your Timken engineer for more information.

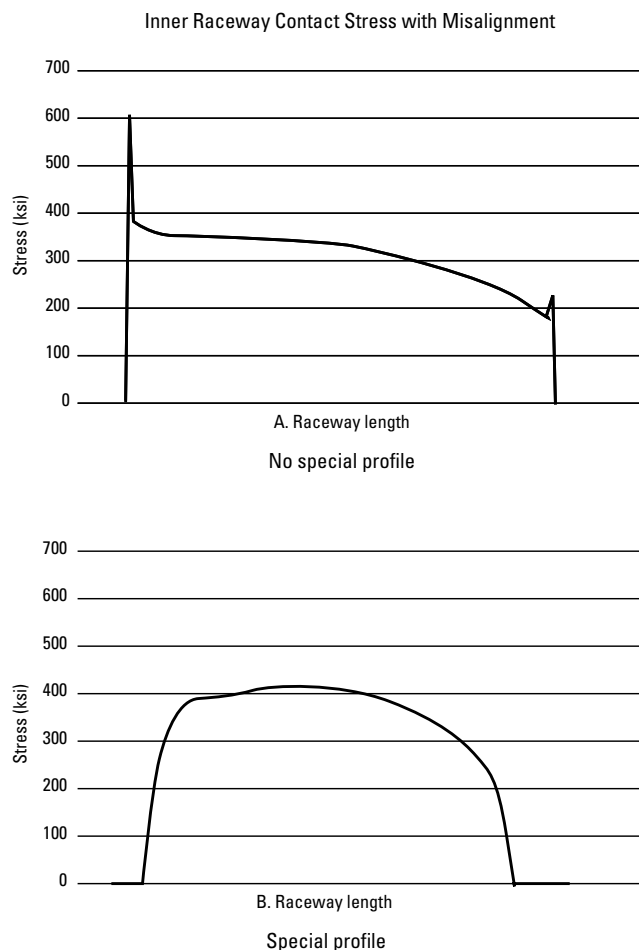

Fig. 31. Tapered roller bearing contact stress under misaligned condition.

SYSTEM LIFE AND WEIGHTED AVERAGE LOAD AND LIFE

SYSTEM LIFE

System reliability is the probability that all of the given bearings in a system will attain or exceed some required life. System reliability is the product of the individual bearing reliabilities in the system:

$$R_{(\text{system})} = R_A R_B R_C \dots R_n$$

In the application, the L_{10} system life for a number of bearings each having different L_{10} life is:

$$L_{10(\text{system})} = [(1/L_{10A})^{3/2} + (1/L_{10B})^{3/2} + \dots (1/L_{10n})^{3/2}]^{-2/3}$$

WEIGHTED AVERAGE LOAD AND LIFE EQUATIONS

In many applications, bearings are subjected to various conditions of loading, and bearing selection is often made on the basis of maximum load and speed. However, under these conditions, a more meaningful analysis may be made by examining the loading cycle to determine the weighted average load.

Bearing selection based on weighted average loading will take into account variations in speed, load and proportion of time during which the variable loads and speeds occur. However, it is still necessary to consider extreme loading conditions to evaluate bearing contact stresses and alignment.

WEIGHTED AVERAGE LOAD

Variable speed, load and proportion time:

$$F_{wt} = [(n_1 t_1 F_1^{10/3} + \dots n_n t_n F_n^{10/3}) / n_a]^{0.3}$$

Uniformly increasing load, constant speed:

$$F_{wt} = [(3/13) (F_{\max}^{13/3} - F_{\min}^{13/3}) / (F_{\max} - F_{\min})]^{0.3}$$

Use of the weighted average load in the bearing life equation does not take into account the effects of different speeds on the lubrication factor a_3 . For load cycles with varying speeds, it is recommended that life calculations be made for each condition and that the life for each condition be plugged into the weighted average life equation.

WEIGHTED AVERAGE LIFE

$$L_{nwt} = 1 / \{ [t_1 / (L_n)_1] + [t_2 / (L_n)_2] + \dots [t_n / (L_n)_n] \}$$

BEARING TOLERANCES, METRIC AND INCH SYSTEMS

Ball and roller bearings are manufactured to a number of specifications, with each having classes that define dimensional tolerances such as inside diameter, outside diameter, width and runout. In addition, bearings are produced in both inch and metric systems with the boundary dimension tolerances being different for these two systems. The major difference between the two systems is that inch bearings have historically been manufactured to positive bore and O.D. tolerances, whereas metric bearings have been manufactured to corresponding standard negative tolerances.

The following table summarizes the different specifications and classes for ball, tapered roller, cylindrical roller and spherical roller bearings. For the purpose of this catalog, ISO specifications are shown for ball, cylindrical roller and spherical roller bearings. Timken specifications are shown for tapered roller bearings. Timken® thrust tapered roller bearings comply with current ABMA inch system standard 23.2. Standard Timken® ball, spherical roller and cylindrical roller thrust bearings maintain normal metric system tolerances according to the current ISO standard 199.

TABLE 2. BEARING SPECIFICATIONS AND CLASSES

System	Specification	Bearing Type	Standard Bearing Class		Precision Bearing Class	
Metric	Timken	Tapered Roller Bearings	K	N	C	B
	ISO/DIN	All Bearing Types	P0	P6	P5	P4
	ABMA	Cylindrical, Spherical Roller Bearings	RBEC 1	RBEC 3	RBEC 5	RBEC 7
		Ball Bearings	ABEC 1	ABEC 3	ABEC 5	ABEC 7
		Tapered Roller Bearings (Not XR)	K	N	C	B
	Crossed Roller Bearings	–	–	S	P	
Inch	Timken	Tapered Roller Bearings	4	2	3	0
	ABMA	Tapered Roller Bearings	4	2	3	0

The term deviation is defined as the difference between a single ring dimension and the nominal dimension. For metric tolerances, the nominal dimension is at a +0 mm (0 in.) tolerance. The deviation is the tolerance range for the listed parameter. Variation is defined as the difference between the largest and smallest measurements of a given parameter for an individual ring.

Boundary dimension tolerances for Timken thrust bearings are listed in the following tables (pages 30-35). These tolerances are provided for use in selecting bearings for general applications in conjunction with the bearing mounting and fitting practices offered in later sections.

THRUST BALL BEARING TOLERANCES

TABLE 3. THRUST BALL BEARING TOLERANCES – TYPES TVL AND DTVL

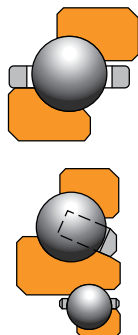

Bore			O.D.			Width		
Bearing Bore		Tolerance ⁽¹⁾	Bearing O.D.		Tolerance ⁽¹⁾	Bearing Width		Tolerance Max.
Over	Incl.		Over	Incl.		Over	Incl.	
mm in.	mm in.	mm in.	mm in.	mm in.	mm in.	mm in.	mm in.	mm in.
0.000 0.0000	504.825 19.8750	-0.076 -0.0030	0.000 0.0000	584.000 23.0000	-0.076 -0.0030	All Sizes		±0.381 ±0.0150
504.825 19.8750	1524.000 60.0000	-0.127 -0.0050	584.000 23.0000	1778.000 70.0000	-0.127 -0.0050			–
								–

⁽¹⁾The tolerances in this table conform to ABMA Standard 21.2.

THRUST SPHERICAL ROLLER BEARING TOLERANCES

TABLE 4. THRUST SPHERICAL ROLLER BEARING TOLERANCES

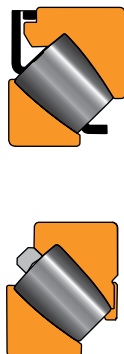

Bore			O.D.			Width			
Bearing Bore		Tolerance ⁽¹⁾	Bearing O.D.		Tolerance ⁽¹⁾	Bearing Width		Tolerance	
Over	Incl.		Over	Incl.		Over	Incl.	Max.	Min.
mm in.	mm in.	mm in.	mm in.	mm in.	mm in.	mm in.	mm in.	mm in.	mm in.
80.000 3.1496	120.000 4.7244	-0.020 -0.0008	120.000 4.7244	150.000 5.9055	-0.020 -0.0080	80.000 3.1496	120.000 4.7244	+0.094 +0.0037	-0.254 -0.0100
120.000 4.7244	180.000 7.0866	-0.025 -0.0010	150.000 5.9055	180.000 7.0866	-0.025 -0.0010	120.000 4.7244	180.000 7.0866	+0.109 +0.0043	-0.300 -0.0118
180.000 7.0866	250.000 9.8425	-0.030 -0.0012	180.000 7.0866	250.000 9.8425	-0.030 -0.0012	180.000 7.0866	250.000 9.8425	+0.130 +0.0051	-0.366 -0.0144
250.000 9.8425	315.000 12.4016	-0.036 -0.0014	250.000 9.8425	315.000 12.4016	-0.036 -0.0014	250.000 9.8425	315.000 12.4016	+0.155 +0.0061	-0.434 -0.0171
315.000 12.4016	400.000 15.7480	-0.041 -0.0016	315.000 12.4016	400.000 15.7480	-0.041 -0.0016	315.000 12.4016	400.000 15.7480	+0.170 +0.0067	-0.480 -0.0189
400.000 15.7480	500.000 19.6850	-0.046 -0.0018	400.000 15.7480	500.000 19.6850	-0.046 -0.0018	400.000 15.7480	500.000 19.6850	+0.185 +0.0073	-0.526 -0.0207
500.000 19.6850	630.000 24.8031	-0.051 -0.0020	500.000 19.6850	630.000 24.8031	-0.051 -0.0020	500.000 19.6850	and up	+0.203 +0.0080	-0.584 -0.0230
630.000 24.8031	800.000 31.4961	-0.076 -0.0030	630.000 24.8031	800.000 31.4961	-0.076 -0.0030	–	–	–	–
800.000 31.4961	1000.000 39.3701	-0.102 -0.0040	800.000 31.4961	1000.000 39.3701	-0.102 -0.0040	–	–	–	–
1000.000 39.3701	1250.000 49.2126	-0.127 -0.0050	1000.000 39.3701	1250.000 49.2126	-0.127 -0.0050	–	–	–	–
–	–	–	1600.000 62.9921	-0.165 -0.0065	0.193 0.0076	–	–	–	–
–	–	–	2000.000 78.7402	-0.203 -0.0080	0.229 0.009	–	–	–	–

⁽¹⁾Tolerance range is from +0 to value listed.

THRUST CYLINDRICAL ROLLER BEARING TOLERANCES

TABLE 5. THRUST CYLINDRICAL ROLLER BEARING TOLERANCES – TYPE TP

Bore			O.D.			Width		
Bearing Bore		Tolerance ⁽¹⁾	Bearing O.D.		Tolerance ⁽¹⁾	Bearing Width		Tolerance Max.
Over	Incl.		Over	Incl.		Over	Incl.	
mm	mm	mm	mm	mm	mm	mm	mm	mm
in.	in.	in.	in.	in.	in.	in.	in.	in.
50.800	76.200	-0.025	127.000	254.000	+0.038	0.000	50.800	-0.152
2.0000	3.0000	-0.0010	5.0000	10.0000	+0.0015	0.0000	2.0000	-0.0060
76.200	88.900	-0.030	254.000	457.200	+0.051	50.800	76.200	-0.203
3.0000	3.5000	-0.0012	10.0000	18.0000	+0.0020	2.0000	3.0000	-0.0080
88.900	228.600	-0.038	457.200	660.400	+0.640	76.200	152.400	-0.254
3.5000	9.0000	-0.0015	18.0000	26.0000	+0.0025	3.0000	6.0000	-0.0100
228.600	304.800	-0.046	660.400	863.600	+0.076	152.400	254.000	-0.381
9.0000	12.0000	-0.0018	26.0000	34.0000	+0.0030	6.0000	10.0000	-0.0150
304.800	457.200	-0.051	863.600	1117.600	+0.102	254.000	457.200	-0.508
12.0000	18.0000	-0.0020	34.0000	44.0000	+0.0040	10.0000	18.0000	-0.0200
457.200	558.800	-0.064				457.200	762.000	-0.635
18.0000	22.0000	-0.0025				18.0000	30.0000	-0.0250
558.800	762.000	-0.076						
22.0000	30.0000	-0.0030						

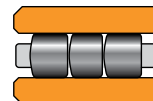

⁽¹⁾The tolerances in this table conform to ABMA Standard 21.2.

TABLE 6. THRUST CYLINDRICAL ROLLER BEARING TOLERANCES – TYPE TPS

Bore			O.D.			Width		
Bearing Bore		Tolerance ⁽¹⁾	Bearing O.D.		Tolerance ⁽¹⁾	Bearing Width		Tolerance Max.
Over	Incl.		Over	Incl.		Over	Incl.	
mm	mm	mm	mm	mm	mm	mm	mm	mm
in.	in.	in.	in.	in.	in.	in.	in.	in.
50.800	76.200	-0.025	127.000	266.700	+0.048	0.000	50.800	-0.203
2.0000	3.0000	-0.0010	5.0000	10.5000	+0.0019	0.0000	2.0000	-0.0080
76.200	88.900	-0.030	266.700	323.850	+0.053	50.800	76.200	-0.254
3.0000	3.5000	-0.0012	10.5000	12.7500	+0.0021	2.0000	3.0000	-0.0100
88.900	228.600	-0.038	323.850	431.800	+0.058	76.200	152.400	-0.381
3.5000	9.0000	-0.0015	12.7500	17.0000	+0.0023	3.0000	6.0000	-0.0150
228.600	304.800	-0.046	431.800	685.800	+0.064	152.400	254.000	-0.508
9.0000	12.0000	-0.0018	17.0000	27.0000	+0.0025	6.0000	10.0000	-0.0200
304.800	457.200	-0.051	685.800	889.000	+0.076	254.000	457.200	-0.635
12.0000	18.0000	-0.0020	27.0000	35.0000	+0.0030	10.0000	18.0000	-0.0250
457.200	558.800	-0.064				457.200	762.000	-0.762
18.0000	22.0000	-0.0025				18.0000	30.0000	-0.0300
558.800	762.000	-0.076						
22.0000	30.0000	-0.0030						

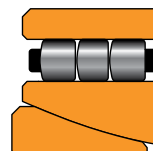

⁽¹⁾The tolerances in this table conform to ABMA Standard 21.2.

THRUST TAPERED ROLLER BEARING TOLERANCES

INCH BEARINGS

Bore tolerances

TABLE 7. THRUST TAPERED ROLLER BEARINGS – BORE TOLERANCES

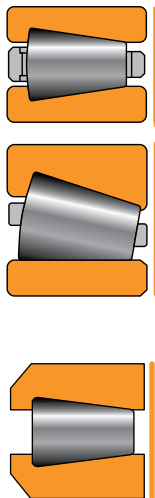

Bearing Types	Bore		Tolerance	
	Over	Incl.	Max.	Min.
	mm in.	mm in.	mm in.	mm in.
TTHD TTHDFL TTHDFLSA TTDW TTDK TTHDSX-1 TTHDSX-2 TTHDSV-1 TTHDSV-2	0.000 0.0000	304.800 12.0000	+0.025 +0.0010	+0.000 +0.0000
	304.800 12.0000	609.600 24.0000	+0.051 +0.0020	+0.000 +0.0000
	609.600 24.0000	914.400 36.0000	+0.076 +0.0030	+0.000 +0.0000
	914.400 36.0000	1219.200 48.0000	+0.102 +0.0040	+0.000 +0.0000
	1219.200 48.0000	–	+0.127 +0.0050	+0.000 +0.0000
TTSP TTSPS TTC TTCS TTCL	0.000 0.0000	25.400 1.0000	+0.076 +0.0030	-0.076 -0.0030
	25.400 1.0000	76.200 3.0000	+0.102 +0.0040	-0.102 -0.0040
	76.200 3.0000	–	+0.127 +0.0050	-0.127 -0.0050

INCH BEARINGS

Outside diameter tolerances

TABLE 8. THRUST TAPERED ROLLER BEARINGS – OUTSIDE DIAMETER TOLERANCES

Bearing Types	O.D.		Tolerance	
	Over	Incl.	Max.	Min.
	mm in.	mm in.	mm in.	mm in.
TTHD TTHDFL TTHDFLSA TTDW TTDK TTHDSX-1 TTHDSV-1 TTHDSV-2	0.000 0.0000	304.800 12.0000	+0.025 +0.0010	+0.000 +0.0000
	304.800 12.0000	609.600 24.0000	+0.051 +0.0020	+0.000 +0.0000
	609.600 24.0000	914.400 36.0000	+0.076 +0.0030	+0.000 +0.0000
	914.400 36.0000	1219.200 48.0000	+0.102 +0.0040	+0.000 +0.0000
	1219.200 48.0000	–	+0.127 +0.0050	+0.000 +0.0000
TTHDFLSX-1 TTHDFLSX-2 TTHDFLSX-3 TTHDFLSV-1 TTHDFLSV-2 TTHDDV	0.000 0.0000	317.500 12.5000	+0.000 +0.0000	-0.025 -0.0010
	317.500 12.5000	647.700 25.5000	+0.000 +0.0000	-0.051 -0.0020
TTHDFLSX-1 TTHDFLSX-2 TTHDFLSX-3 TTHDFLSV-1 TTHDFLSV-2 TTHDDV	0.000 0.0000	520.700 20.5000	+0.000 +0.0000	-0.127 -0.0050
	520.700 20.5000	647.700 25.5000	+0.000 +0.0000	-0.254 -0.0100
TTSP TTSPS TTC TTCS TTCL	0.000 0.0000	127.000 5.0000	+0.254 +0.0100	0.000 0.0000
	127.000 5.0000	203.200 8.0000	+0.381 +0.0150	0.000 0.0000
	203.200 8.0000	–	+0.508 +0.2000	0.000 0.0000

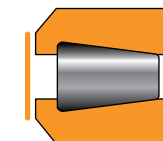
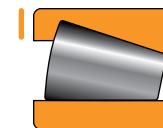
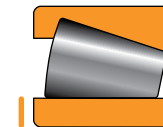
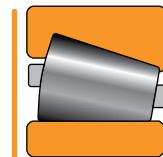
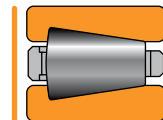

INCH BEARINGS

Width tolerances

TABLE 9. THRUST TAPERED ROLLER BEARING TOLERANCES - WIDTH (INCH)

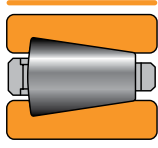
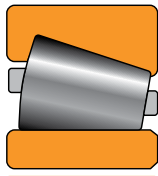
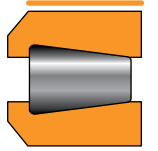
Bearing Types	Bore		Tolerance	
	Over	Incl.	Max.	Min.
	mm in.	mm in.	mm in.	mm in.
 TTHD TTHDFL TTHDFLSA TTHDSX-1 TTHDSX-2 TTHDSV-1 TTHDSV-2 TTHDFLSX-1 TTHDFLSX-2 TTHDFLSX-3 TTHDFLSV-1 TTHDFLSV-2 TTHDDV	All Sizes		+0.381 +0.015	-0.381 -0.015
 TTDW TTDK	All Sizes		+0.762 +0.030	-0.762 -0.030
 TTSP TTSPS TTC TTCS TTCL	0.000 0.0000	76.200 3.0000	+0.254 +0.0100	-0.254 -0.0100
	76.200 3.0000	127.000 5.0000	+0.381 +0.0150	-0.381 -0.0150
	127.000 5.0000	—	+0.508 +0.2000	-0.508 -0.2000

METRIC BEARINGS

TABLE 10. THRUST TAPERED ROLLER BEARINGS – BORE TOLERANCES

Bearing Types	Bore		Tolerance	
	Over	Incl.	Max.	Min.
	mm in.	mm in.	mm in.	mm in.
TTDFLK	80.000 3.1496	120.000 4.7244	+0.000 +0.0000	-0.020 -0.0008
	120.000 4.7244	180.000 7.0866	+0.000 +0.0000	-0.025 -0.0010
	180.000 7.0866	250.000 9.8425	+0.000 +0.0000	-0.030 -0.0012
	250.000 9.8425	315.000 12.4016	+0.000 +0.0000	-0.035 -0.0014
	315.000 12.4016	400.000 15.7480	+0.000 +0.0000	-0.040 -0.0016
	400.000 15.7480	500.000 19.6850	+0.000 +0.0000	-0.045 -0.0018
	500.000 19.6850	630.000 24.8031	+0.000 +0.0000	-0.050 -0.0020

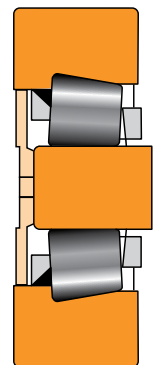
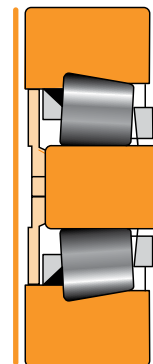

TABLE 11. THRUST TAPERED ROLLER BEARINGS – OUTSIDE DIAMETER TOLERANCES

Bearing Types	O.D.		Tolerance	
	Over	Incl.	Max.	Min.
	mm in.	mm in.	mm in.	mm in.
TTDFLK	80.000 3.1496	120.000 4.7244	+0.000 +0.0000	-0.022 -0.0009
	120.000 4.7244	180.000 7.0866	+0.000 +0.0000	-0.025 -0.0010
	180.000 7.0866	250.000 9.8425	+0.000 +0.0000	-0.030 -0.0012
	250.000 9.8425	315.000 12.4016	+0.000 +0.0000	-0.035 -0.0014
	315.000 12.4016	400.000 15.7480	+0.000 +0.0000	-0.040 -0.0016
	400.000 15.7480	500.000 19.6850	+0.000 +0.0000	-0.045 -0.0018
	500.000 19.6850	630.000 24.8031	+0.000 +0.0000	-0.050 -0.0020
	630.000 24.8031	800.000 31.4961	+0.000 +0.0000	-0.075 -0.0030
	800.000 31.4961	1000.000 39.3701	+0.000 +0.0000	-0.100 -0.0039
	1000.000 39.3701	1250.000 49.2126	+0.000 +0.0000	-0.125 -0.0049
	1250.000 49.2126	1600.000 62.9921	+0.000 +0.0000	-0.160 -0.0063



Width tolerances

Please contact your Timken engineer for information on the metric thrust bearing width tolerances.

MOUNTING DESIGN, FITTING PRACTICE AND SETTING

To achieve expected bearing performance, it is critical to follow proper mounting design, fitting practices, settings and installation procedures. While there are different practices between thrust tapered roller, cylindrical roller, spherical roller and ball bearings, there are many similarities that apply to all. These similarities are summarized in the sections below, followed by a summary of practices specific to each bearing type.

MOUNTING DESIGN

All bearing types are typically mounted onto a shaft and into a housing where the shaft and housing have surfaces supporting the rings. These surfaces establish the axial location and alignment under all operating conditions. It is essential that a shoulder be square with the bearing ring and of sufficient diameter and axial section to provide adequate backing of the bearing raceway. It also must be of sufficient section to resist axial movement and excessive deflection under loading. Wear resistance at the interface with the bearing rings must be considered.

It is highly recommended that roller bearing shaft seats be ground to a surface finish of $1.6 \mu\text{m}$ ($65 \mu\text{in}$) Ra maximum. Ball bearing seats should be $0.8 \mu\text{m}$ ($32 \mu\text{in}$) for shafts under 2 inches and $1.6 \mu\text{m}$ ($65 \mu\text{in}$) for all other sizes.

When shaft seats are turned, a tighter heavy-duty fit should be selected to ensure interference fit pressure and to prevent rotation. The shaft diameter should be turned to a finish of $3.2 \mu\text{m}$ ($125 \mu\text{in}$) Ra maximum.

Housing inside diameters should be finished to $3.2 \mu\text{m}$ ($125 \mu\text{in}$) Ra maximum.

ANGULAR CONTACT THRUST BALL BEARINGS – TYPES TVL AND DTVL

The TVL is a separable single-row angular contact ball bearing designed for unidirectional axial loads. The angular contact design, however, will accommodate combined radial and axial loads since the loads are transmitted angularly through the balls. The DTVL is similar in design to TVL except that the DTVL has an additional ring and ball complement permitting it to carry moderate forces in both directions.

Both TVL and DTVL are used extensively in rotary table applications in the oil and gas drilling industry. Rotary table operation generates upward and downward axial loads while being supported and positioned by two main thrust bearings, often of the angular contact thrust ball type. The upper or main position takes the predominant downward axial loads. The lower position, which also is known as the hold down bearing, handles the upward axial load and the majority of the radial loading due to gear forces or dynamic imbalance of the rotating components, fixtures and drill pipe.

An example of arrangements of the angular contact thrust ball bearings includes using one size TVL in the main position, and another size in the lower position, as illustrated in fig. 32. Another popular mounting arrangement is to use a single DTVL as a triple-ring combination bearing to handle thrust loads in both directions at the same time (see fig. 33).

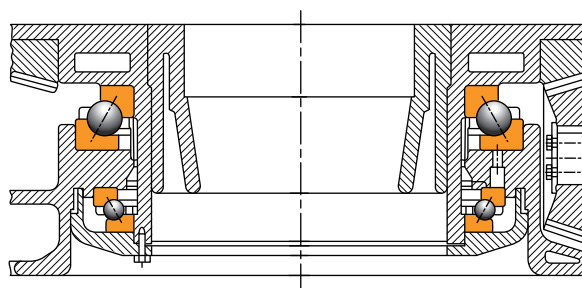

Fig. 32. Large TVL in main position, small TVL in lower position.

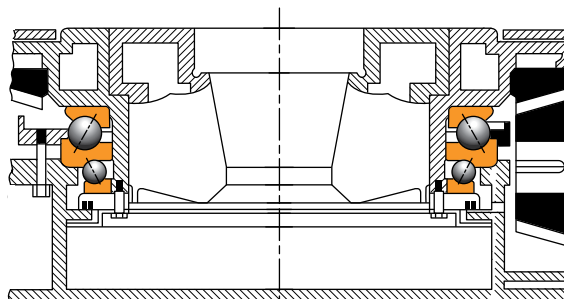

Fig. 33. DTVL mounting to accommodate bi-directional loads.

THRUST CYLINDRICAL ROLLER BEARINGS – TYPES TP AND TPS

Thrust cylindrical roller bearings are generally used in applications where high axial loads are present. Timken TP and TPS thrust cylindrical roller bearings are used in a variety of heavy industrial equipment and challenging thrust applications. Mineral and aggregate crushers and pulverizers are typical examples where thrust cylindrical roller bearings are used in primary thrust support positions to handle the loads applied during the compressive breakdown of aggregate (see fig. 34). Dependent on mounting and axial force applications, these bearings can accommodate moderate overturning moments.

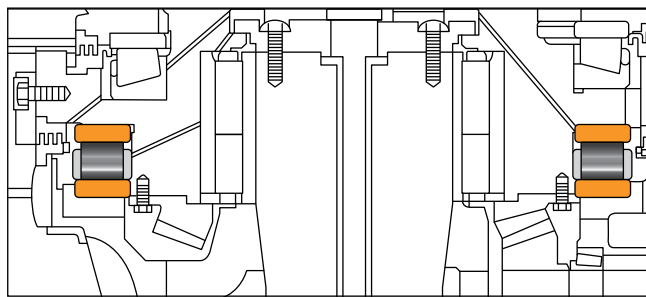

Fig. 34. Typical mounting arrangement of thrust cylindrical roller bearing in crusher application.

Mounting is typically handled by hoisting mechanisms in a shop environment, but may be assembled manually in the field during replacement situations. Mounting of TP and TPS bearings with loose fitting practice on both the shaft and housing is common to allow ease of installation. However, depending on bearing reaction torque, anti-rotation features may be required.

THRUST SPHERICAL ROLLER BEARINGS – TYPE TSR

Thrust spherical roller bearings are used to support axial force in a wide variety of industrial machinery. They can be mounted at axial positions on vertical shafts (e.g. crushers), or mounted horizontally as in long product mill, flat product mill, and cold mill works or intermediate rolls with axial shifting. These assemblies are best suited for applications where accommodation of heavy roll bending and high misalignment is required. Timken thrust spherical roller bearings are capable of handling misalignment between the inner and outer ring of up to 2.5 degrees in either direction.

Bearing outer rings must be mounted with a loose fit to isolate radial loads when used as pure thrust bearings. When used in a shaft position and reacting to radial and axial forces, special housing fitting practice is required. To support axial loads in both directions, thrust spherical roller bearings are often mounted in pairs. In such situations, a spring system maintains the outer races in contact with the rollers on the unloaded row. An axial clearance must be established during mounting using a shim pack between the chock and the cover. Housing components must be designed to accommodate preload springs or precision axial clearance setting.

A cartridge or adapter ring is sometimes used with the inner rings tight fitted on a sleeve and the sleeve loose fitted and keyed on the shaft (see figs. 35 and 36 for typical mountings of EJ and EM styles respectively).

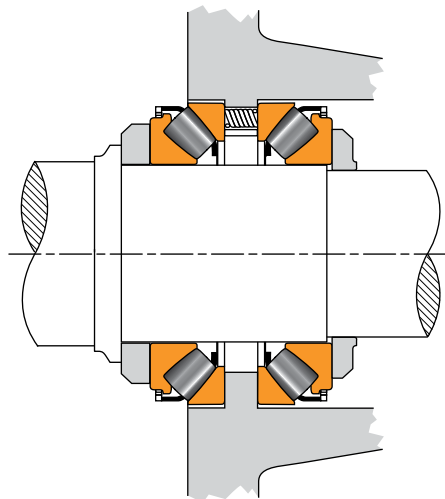

Fig. 35. Back-to-back mounting arrangement of a TSR-EJ bearing set.

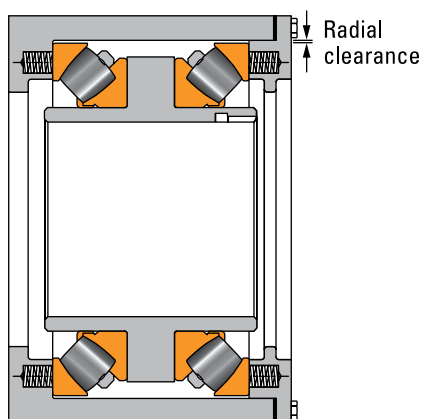

Fig. 36. Face-to-face mounting arrangement of a TSR-EM bearing set.

To maximize axial load support in both directions, thrust spherical roller bearings are often mounted in a tandem face-to-face arrangement (see fig. 36-37). This configuration is common in rollneck applications in the metals industry. In such cases, the inner rings can be clamped in position against each other using inner ring spacers. In applications where surrounding components are mounted in close proximity to the bearing, special care must be taken so that such components do not encroach on the cage or rollers, and so that adequate clearance from the cage and rolling elements is maintained. If there is concern in this regard when mounting thrust spherical roller bearings, contact your Timken representative for support.

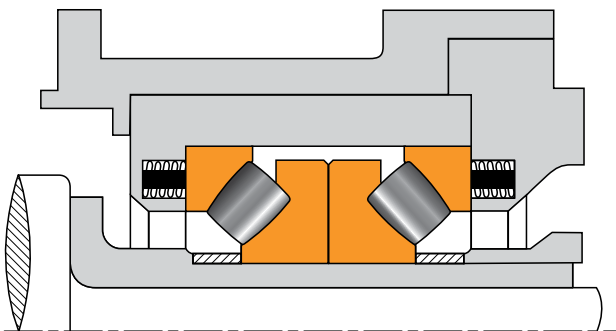

Fig. 37. Typical tandem mount with inner ring spacers.

THRUST TAPERED ROLLER BEARINGS – TYPE TTHD

Thrust tapered roller bearings of type TTHD or TTHDFL are used in a variety of applications such as plastic extruder thrust blocks, oil rig swivels, marine drives and machine tool tables. When mounted, the bearing should be square to the shaft and housing. The backing diameter must be sufficient in the radial direction to support the full length of the rollers, both at the large and small roller ends, and of sufficient axial section to prevent misalignment due to distortion.

In general, the rotating race is mounted with a tight shaft fit, and the stationary race is mounted with a loose housing fit. For TTHDFL, the flat race may be loose fit or tight fit on its outer diameter depending on customer preference.

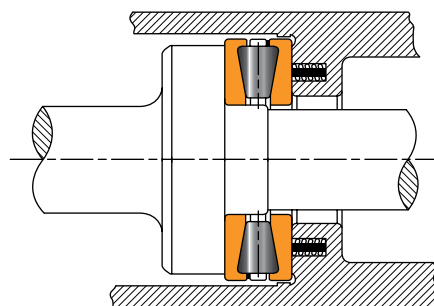

Fig. 38. Typical mounting of a spring-loaded TTHD.

The use of springs is sometimes required on horizontal axis applications where reversing axial loads or shock loads are encountered. Fig. 38 shows a spring-loaded TTHD bearing to keep the housing-supported race in contact with the rolling elements at all times.

THRUST TAPERED ROLLER BEARINGS – SCREWDOWN SYSTEMS – TYPES TTHDSX/SV AND TTHDFLSX/SV

Screwdown bearings of these types are used predominantly in metal mills. The bearings used in screwdown systems include single-row tapered thrust designs that are available in a variety of configurations (see pages 117-126 for further details). The heavy-duty thrust bearing makes the connection between the screwdown and the top roll chock, as shown in fig. 39.

The operating speed of screwdown systems is very low during gap adjustment. Modern mills will either use the electromechanical screwdown system in conjunction with a hydraulic roll force cylinder, or will solely use the hydraulic roll force cylinder. The primary benefit of hydraulic roll force cylinders is their fast response time compared to the electro-mechanical screwdown systems, but the mechanical system gives more precise location with small displacements.

When the mechanical system is used, the screwdown thrust bearing is applied between the main mill screw and top chock. The loads transmitted through these screwdown bearings are extremely high, typically equivalent to half of the mill's separating force, which can be several thousand tons. The operating speed is basically zero as the screw's rotational speed is very slow during adjustment. For this reason, the bearing selection is based on its static capacity (C_0).

Below are a few important considerations to keep in mind when mounting screwdown bearings:

1. **Bearing cartridge:** The bearing is mounted in a cartridge primarily to contain the lubricant needed for the assembly, but also to unitize the entire bearing assembly.
2. **Tapered-bottom race:** If the bottom race is tapered (TTHDSX/SV), then a 3 mm (0.120 in.) radial clearance is suggested relative to the O.D. of the race to ensure that the bottom race will self-align with respect to the upper tapered race. Otherwise, the roller ends will not be properly seated against both the upper and lower large ribs simultaneously. A piloting bushing is pressed into the cartridge and is used for centering the upper race and rollers. The bottom race will be centered by the upper race and roller set.

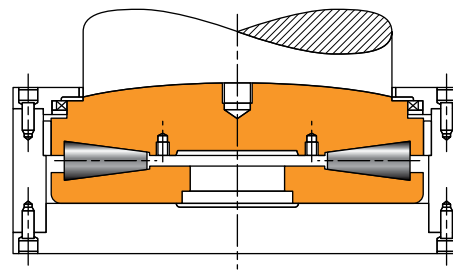

Fig. 39. Typical screwdown support configuration using a TTHDSX thrust bearing.

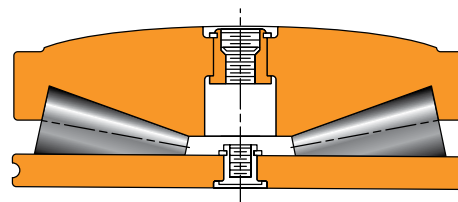

Fig. 40. TTHDFLSX convex upper race design.

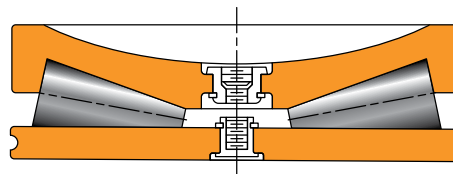

Fig. 41. TTHDFLSV concave upper race design.

3. **Flat-bottom race:** If the bottom race is flat (TTHDFLSX/SV), as in figs. 40-41, then apply close fit as per fitting practice guidelines. The flat race permits radial self-aligning of the rollers and conical raceways.
4. **Sealing:** An oil seal is mounted in the upper plate that is bolted to the cartridge to keep contaminants from entering the bearing assembly.
5. **Lubrication:** Adequate lubrication is maintained by filling the bearing with high-quality EP grease having a viscosity of approximately 450 cSt at 40° C (104° F).

DOUBLE-ACTING HEAVY DUTY THRUST TAPERED ROLLER BEARINGS – TYPES TTDWK AND TTDFLK

The TTDWK or TTDFLK double-acting thrust tapered roller bearing is an excellent choice where extremely high axial loads are anticipated.

Double-acting thrust tapered roller bearings are commonly used in strip mills that generate particularly large thrust forces, as is the case in cross rolling systems.

The TTDWK (fig. 42) bearing includes two flat raceways – one on each side and one tapered double-race thrust ring at the center of the bearing, as well as two sets of rollers that are retained as a unit in a pinned cage.

The TTDFLK (fig. 43), a variant to this TTDWK configuration, uses two tapered raceways (one on each side) and a flat, double-race thrust ring at its center.

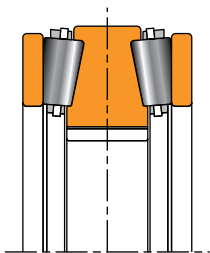

Fig. 42. Typical TTDWK assembly (with flat outer raceways).

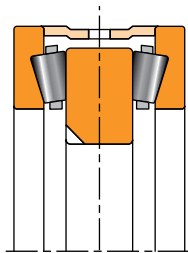

Fig. 43. Typical TTDFLK assembly (with flat double inner raceways).

The TTDWK double-acting thrust bearing is usually mounted in combination with a radial bearing at the fixed position (fig. 44). Such an assembly is fitted in a separate housing that will be mounted on the chock. The outer races are not axially clamped, but adjusted to obtain the required axial clearance, allowing the springs to develop the correct axial force to seat the unloaded row. A keyway is generally provided in the center double-race ring to stop it from rotating on the roll neck.

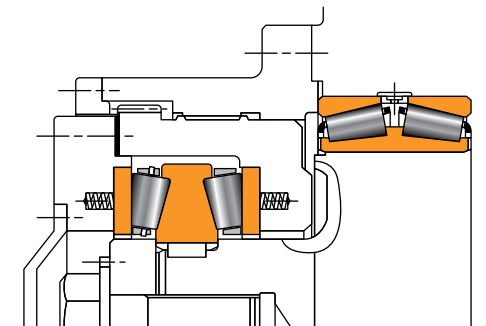

Fig. 44. Typical TTDWK thrust bearing arrangement.

The TTDFLK bearing, on the other hand, is preset and does not require adjustment during mounting. If the bearing is supplied without a spacer, then the same spring arrangement and adjustment as the TTDWK must be used.

The assembly must be axially clamped using metal shims or a compressible gasket, as shown in fig. 45. This bearing can also be ordered without the spacer and then mount it like the TTDWK (fig. 46).

These double-acting bearings (TTDWK and TTDFLK) can only be installed as a unit. Take care to ensure that the flat races are correctly centered when lifting or lowering this bearing into the housing.

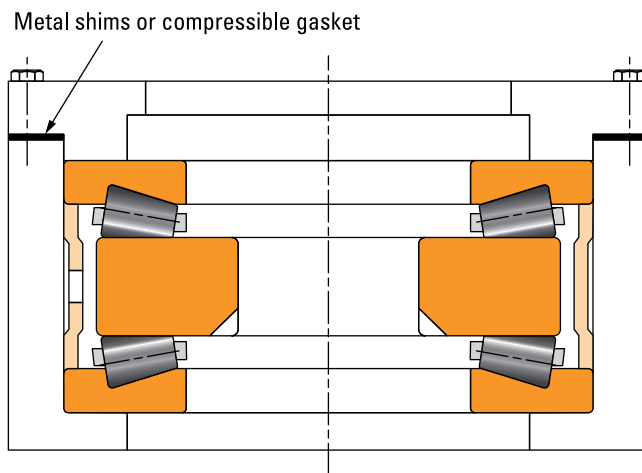

Fig. 45. TTDFLK thrust bearing mounted in housing.

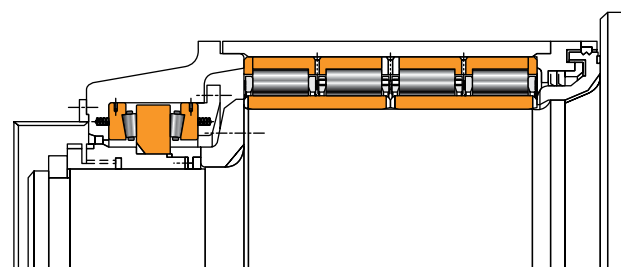

Fig. 46. TTDFLK thrust assembly typical mounting.

CROSSED ROLLER BEARINGS

TXR (DO)

A typical mounting arrangement for the type TXRDO crossed roller bearing is shown in fig. 47.

The arrangement shown is for lubrication by oil circulation in conjunction with an oil level maintained within the bearing. It can, however, be designed for grease lubrication with appropriate sealing arrangements.

The bore of the housing (DH) and the diameter of the spigot (DS) (fig. 48) should be machined to give a mean of the suggested interference fits (pages 48-49).

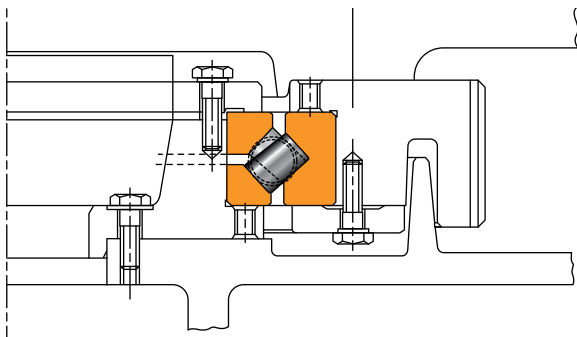

Fig. 47. Typical mounting arrangement of a TXRDO bearing.

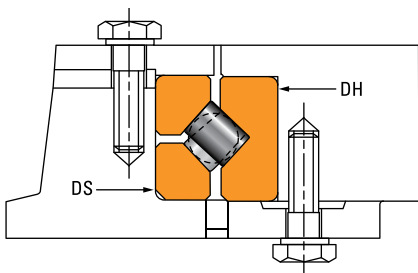

Fig. 48. Fitting and setting of TXR bearing.

The bearing is adjusted externally by segments beneath the top inner-ring clamping plate to get the required preload.

Your Timken engineer should be consulted for more details about the use of crossed roller bearings.

AUXILIARY EQUIPMENT AND OTHER BEARING TYPE MOUNTING PROCEDURES

For industry-standard bearing types, please refer to the following Timken catalogs for mounting procedures – Timken® Tapered Roller Bearing Catalog (order no. 10481), Timken® Cylindrical Roller Bearing Catalog (order no. 10447), Timken® Spherical Roller Bearing Catalog (order no. 10446) and the Timken® Engineering Manual (order no. 10424).

FITTING PRACTICE

As a general guideline, bearing rings mounted on a rotating member should have an interference fit. For some thrust bearing applications, the ring is pinned to the rotating shaft. Loose fits may permit the ring to creep or turn and wear the mating surface and backing shoulder. This wear can result in excessive bearing looseness which can lead to damage of the bearing, shaft or housing. Many thrust bearing applications have outer rings mounted with a clearance to insulate them from radial loads and to allow axial float.

The choice of fitting practices will mainly depend upon the following parameters:

- Precision class of the bearing.
- Rotating or stationary ring.
- Type of layout (single- or double-row bearings).
- Type and direction of load (continuous/alternate rotating, overturning moments).
- Particular running conditions like shocks, vibrations, overloading or high speed.
- Capability for machining the seats (grinding, turning or boring).
- Shaft and housing section and material.
- Mounting and setting conditions.

General fitting practice guidelines for thrust bearings having a bore less than 304.8 mm (12 in.) are:

Rotating race

- Use a tight fit with horizontal shafts; vertical shafts may consider split or loose fit.
- Use a clearance with housing.

Stationary race

- Use a loose fit on shaft and clearance with housing.

For bore sizes greater than 304.8 mm (12 in.), contact your Timken engineer. Detailed fitting practices for various thrust bearing types are listed in the following tables 12-26.

ANGULAR CONTACT THRUST BALL BEARING FITS

Shaft and housing diameters are shown as variance from nominal dimensions.



TABLE 12. SHAFT FITS – ANGULAR CONTACT THRUST BALL BEARINGS – TYPE TVL AND DTVL

Bearing Bore Nominal		Shaft Diameter			
		Interference Fit ⁽¹⁾		Loose Fit ⁽²⁾	
Over	Incl.	Max.	Min.	Max.	Min.
mm in.	mm in.	mm in.	mm in.	mm in.	mm in.
0.000 0.0000	504.825 19.8750	+0.076 +0.0030	+0.000 +0.0000	-0.152 -0.0060	-0.076 -0.0030
504.825 19.8750	1524.000 60.0000	+0.127 +0.0050	+0.000 +0.0000	-0.254 -0.0100	-0.127 -0.0050

⁽¹⁾Dowel pin suggested.

⁽²⁾Dowel pin required.

TABLE 13. HOUSING FITS – ANGULAR CONTACT THRUST BALL BEARINGS – TYPE TVL AND DTVL

Bearing O.D. Nominal		Housing Diameter			
		Interference Fit ⁽¹⁾		Loose Fit ⁽²⁾	
Over	Incl.	Max.	Min.	Max.	Min.
mm in.	mm in.	mm in.	mm in.	mm in.	mm in.
0.000 0.0000	584.000 23.0000	-0.152 -0.0060	-0.076 -0.0030	+0.152 +0.0060	0.076 0.0030
584.000 23.0000	1778.000 70.0000	-0.254 -0.0100	-0.127 -0.0050	+0.254 +0.0100	0.127 0.0050

⁽¹⁾Dowel pin suggested.

⁽²⁾Dowel pin required.

THRUST CYLINDRICAL ROLLER BEARING FITS

Tolerances for housing bore and for shaft diameters shown as variance from nominal bearing dimension.

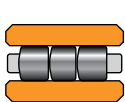

TP

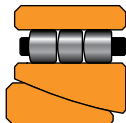

TPS

TABLE 14. SHAFT FITS – THRUST CYLINDRICAL ROLLER BEARING – TYPE TP AND TPS

Bearing Bore Nominal		Shaft Diameter	
Over	Incl.	Max.	Min.
mm in.	mm in.	mm in.	mm in.
47.625 1.8750	53.975 2.1250	-0.025 -0.0010	-0.051 -0.0020
53.975 2.1250	63.500 2.5000	-0.028 -0.0011	-0.053 -0.0021
63.500 2.5000	76.200 3.0000	-0.030 -0.0012	-0.056 -0.0022
76.200 3.0000	88.900 3.5000	-0.033 -0.0012	-0.058 -0.0023
88.900 3.5000	177.800 7.0000	-0.038 -0.0015	-0.064 -0.0025
177.800 7.0000	228.600 9.0000	-0.038 -0.0015	-0.076 -0.0030
228.600 9.0000	304.800 12.0000	-0.046 -0.0018	-0.084 -0.00330
304.800 12.0000	381.000 15.0000	-0.051 -0.0020	-0.089 -0.0035
381.000 15.0000	482.600 19.0000	-0.051 -0.0020	-0.102 -0.0040
482.600 19.0000	584.200 23.0000	-0.064 -0.0025	-0.114 -0.0045
584.200 23.0000	762.000 30.0000	-0.076 -0.0030	-0.140 -0.0055

TABLE 15. HOUSING FITS – THRUST CYLINDRICAL ROLLER BEARING – TYPE TP

Bearing O.D. Nominal		Housing Diameter Deviation from D	
Over	Incl.	Max.	Min.
mm in.	mm in.	mm in.	mm in.
115.092 4.5312	254.000 10.0000	+0.076 +0.0030	+0.038 +0.0015
254.000 10.0000	457.200 18.0000	+0.102 +0.0040	+0.051 +0.002
457.200 18.0000	558.800 22.0000	+0.127 +0.0050	+0.064 +0.0025
558.800 22.0000	660.400 26.0000	+0.140 +0.0055	+0.064 +0.0025
660.400 26.0000	711.200 28.0000	+0.152 +0.0060	+0.076 +0.0030
711.200 28.0000	863.600 34.0000	+0.178 +0.0070	+0.076 +0.0030
863.600 34.0000	965.200 38.0000	+0.203 +0.0080	+0.089 +0.0035
965.200 38.0000	1117.600 44.0000	+0.229 +0.0090	+0.102 +0.0040

TABLE 16. HOUSING FITS – THRUST CYLINDRICAL ROLLER BEARING – TYPE TPS

Bearing O.D. Nominal		Housing Diameter Deviation from D	
Over	Incl.	Max.	Min.
mm in.	mm in.	mm in.	mm in.
50.800 2.0000	60.325 2.3750	+0.038 +0.0015	+0.013 +0.0005
60.325 2.3750	82.550 3.2500	+0.043 +0.0017	+0.018 +0.0007
82.550 3.2500	93.663 3.6875	+0.048 +0.0019	+0.023 +0.0009
93.663 3.6875	101.600 4.0000	+0.053 +0.0021	+0.028 +0.0011
101.600 4.0000	115.092 4.5312	+0.071 +0.0028	+0.033 +0.0013
115.092 4.5312	254.000 10.0000	+0.076 +0.0030	+0.038 +0.0015
254.000 10.0000	457.200 18.0000	+0.102 +0.0040	+0.051 +0.0020
457.200 18.0000	558.800 22.0000	+0.127 +0.0050	+0.064 +0.0025
558.800 22.0000	660.400 26.0000	+0.140 +0.0055	+0.064 +0.0025
660.400 26.0000	711.200 28.0000	+0.152 +0.0060	+0.076 +0.0030
711.200 28.0000	863.600 34.0000	+0.178 +0.0070	+0.076 +0.0030
863.600 34.0000	965.200 38.0000	+0.203 +0.0080	+0.089 +0.0035
965.200 38.0000	1117.600 44.0000	+0.229 +0.0090	+0.102 +0.0040

THRUST SPHERICAL ROLLER BEARING FITS

Tolerances for housing bore and for shaft diameters are shown as variance from nominal bearing dimension.

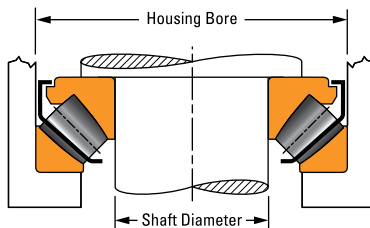

TABLE 17. SHAFT FITS – THRUST SPHERICAL ROLLER BEARINGSS

Bearing Bore Nominal		Shaft Diameter			
		Stationary Load		Rotation Load	
Over	Incl.	Max.	Min.	Max.	Min.
mm in.	mm in.	mm in.	mm in.	mm in.	mm in.
80.000 3.1496	120.000 4.7244	+0.013 +0.0005	-0.010 -0.0004	+0.025 +0.0010	+0.003 +0.0001
120.000 4.7244	180.000 7.0866	+0.015 +0.0006	-0.010 -0.0004	+0.028 +0.0011	+0.003 +0.0001
180.000 7.0866	200.000 7.8740	+0.018 +0.0007	-0.013 -0.0005	+0.036 +0.0014	+0.005 +0.0002
200.000 7.8740	240.000 9.4488	+0.018 +0.0007	-0.013 -0.0005	+0.046 +0.0018	+0.015 +0.0006
240.000 9.4488	315.000 12.4016	+0.018 +0.0007	-0.015 -0.0006	+0.051 +0.0020	+0.020 +0.0008
315.000 12.4016	400.000 15.7480	+0.018 +0.0007	-0.018 -0.0007	+0.056 +0.0022	+0.020 +0.0008
400.000 15.7480	500.000 19.6850	+0.023 +0.0009	-0.018 -0.0007	+0.086 +0.0034	+0.046 +0.0018
500.000 19.6850	630.000 24.8031	+0.023 +0.0009	-0.020 -0.0008	+0.086 +0.0034	+0.043 +0.0017

TABLE 18. HOUSING FITS – THRUST SPHERICAL ROLLER BEARINGS

Bearing O.D. Nominal		Housing Bore					
		Springs in Housing Light Radial Load		Combined Axial & Radial Load			
Over	Incl.	Max.	Min.	Stationary Outer Ring		Rotating Outer Ring	
mm in.	mm in.	mm in.	mm in.	mm in.	mm in.	mm in.	mm in.
180.000 7.0866	250.000 9.8425	+0.061 +0.0024	+0.015 +0.0006	+0.028 +0.0011	-0.018 -0.0007	+0.013 +0.0005	-0.033 -0.0013
250.000 9.8425	315.000 12.4016	+0.069 +0.0027	+0.018 +0.0007	+0.033 +0.0013	-0.018 -0.0007	+0.015 +0.0006	-0.036 -0.0014
315.000 12.4016	400.000 15.7480	+0.074 +0.0029	+0.018 +0.0007	+0.038 +0.0015	-0.018 -0.0007	+0.015 +0.0006	-0.041 -0.0016
400.000 15.7480	500.000 19.6850	+0.084 +0.0033	+0.020 +0.0008	+0.041 +0.0016	-0.023 -0.0009	+0.018 +0.0007	-0.046 -0.0018
500.000 19.6850	630.000 24.8031	+0.091 +0.0036	+0.023 +0.0009	+0.046 +0.0018	-0.023 -0.0009	+0.020 +0.0008	-0.048 -0.0019
630.000 24.8031	800.000 31.4960	+0.102 +0.0040	+0.023 +0.0009	+0.051 +0.0020	-0.023 -0.0009	+0.023 +0.0009	-0.051 -0.0020
800.000 31.4960	1000.000 39.3700	+0.109 +0.0043	+0.025 +0.0010	+0.058 +0.0023	-0.025 -0.0010	+0.025 +0.0010	-0.058 -0.0023
1000.000 39.3700	1250.000 49.2126	+0.122 +0.0048	+0.028 +0.0011	+0.066 +0.0026	-0.028 -0.0011	+0.030 +0.0012	-0.064 -0.0025

NOTE

When application calls for thrust loads only, the housing must be relieved by 1.588 mm (0.0625 in.) on diameter so that no radial load is carried on the bearing.

THRUST TAPERED ROLLER BEARING FITS

Tolerances for housing bore and shaft diameters are shown as variance from nominal bearing dimension.

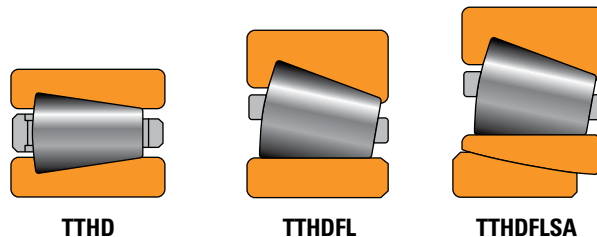

TABLE 19. FITTING GUIDELINES – THRUST TAPERED ROLLER BEARINGS – TYPE TTHD

Bore		Rotating Ring						Stationary Ring
Over	Incl.	Tolerance	Class 2 Shaft O.D. Deviation	Resultant Fit	Tolerance	Class 3 Shaft O.D. Deviation	Resultant Fit	Class 2 and 3
mm in.	mm in.	mm in.	mm in.	mm in.	mm in.	mm in.	mm in.	
0.000 0.0000	304.800 12.0000	0.000 +0.025 0.0000 +0.0010	+0.076 +0.050 +0.0030 +0.0020	0.076T 0.025T 0.0030T 0.0010T	0.000 +0.013 0.0000 +0.0005	+0.051 +0.038 +0.0020 +0.0015	0.051T 0.025T 0.0020T 0.0010T	Provide a minimum radial clearance of 2.5 mm (0.1 in.) between ring bore and shaft O.D. - Rotating ring O.D. must have a minimum radial clearance of 2.5 mm (0.1 in.). - TTHD stationary ring O.D. must have a minimum loose fit of 0.25 to 0.37 mm (0.01 to 0.015 in.). - TTHDFL ring when stationary may be loose fit on its O.D. (same as the TTHD) or may be 0.025 to 0.076 mm (0.001 to 0.003 in.) tight.
304.800 12.0000	609.600 24.0000	0.000 +0.051 0.0000 +0.0020	+0.152 +0.102 +0.0060 +0.0040	0.152T 0.051T 0.0060T 0.0020T	0.000 +0.025 0.0000 +0.0010	+0.102 +0.076 +0.0040 +0.0030	0.102T 0.051T 0.0040T 0.0020T	
609.600 24.0000	914.400 36.0000	0.000 +0.076 0.0000 +0.0030	+0.204 +0.127 +0.0080 +0.0050	0.204T 0.051T 0.0080T 0.0020T	0.000 +0.038 0.0000 +0.0015	+0.127 +0.089 +0.0050 +0.0035	0.127T 0.051T 0.0050T 0.0020T	
914.400 36.0000	1219.200 48.0000	0.000 +0.102 0.0000 +0.0040	+0.254 +0.153 +0.0100 +0.0060	0.254T 0.051T 0.0100T 0.0020T	0.000 +0.051 0.0000 +0.0020	+0.153 +0.102 +0.0060 +0.0040	0.153T 0.051T 0.0060T 0.0020T	
1219.200 48.0000		0.000 +0.127 0.0000 +0.0050	+0.305 +0.178 +0.0120 +0.0070	0.305T 0.051T 0.0120T 0.0020T	0.000 +0.076 0.0000 +0.0030	+0.204 +0.127 +0.0080 +0.0050	0.204T 0.051T 0.0080T 0.0020T	

TABLE 20. SHAFT FITS – THRUST TAPERED ROLLER BEARINGS TYPE TTHDFL AND TTHDFLSA

Bearing Bore Nominal		Shaft Diameter
Over	Incl.	Min. ⁽¹⁾
mm in.	mm in.	mm in.
0.000 0.0000	304.800 12.0000	-0.051 -0.0020
304.800 12.0000	508.000 20.0000	-0.051 -0.0020
508.000 20.0000	711.200 28.0000	-0.076 -0.0030
711.200 28.0000	1219.200 48.0000	-0.102 -0.0040
1219.200 48.0000	1727.200 68.0000	-0.127 -0.0050

⁽¹⁾Tolerance range is from +0 to value listed.

TABLE 21. HOUSING FITS – THRUST TAPERED ROLLER BEARINGS TYPE TTHDFL AND TTHDFLSA

Bearing O.D. Nominal		Housing Bore	
Over	Incl.	Max.	Min.
mm in.	mm in.	mm in.	mm in.
161.925 6.3750	265.113 10.4375	+0.060 +0.0025	+0.025 +0.0010
265.113 10.3475	317.500 12.5000	+0.076 +0.0030	+0.025 +0.0010
317.500 12.5000	482.600 19.0000	+0.102 +0.0040	+0.051 +0.0020
482.600 19.0000	603.250 23.7500	+0.113 +0.0045	+0.051 +0.0020
603.250 23.7500	711.200 28.0000	+0.152 +0.0060	+0.076 +0.0030
711.200 28.0000	838.200 33.0000	+0.178 +0.0070	+0.076 +0.0030

TABLE 22. SHAFT FITS – THRUST TAPERED ROLLER BEARINGS – TYPE TTD, TTDW, TTDWK, TTDF, TTDFLK

Bore Range		Bore Tolerance	Inner Race Seat Deviation	Resultant Fit
Over	Incl.			
mm in.	mm in.	mm in.	mm in.	mm in.
0.000	76.200	0.000	-51	51L
0.0000	3.0000	+0.0000	-0.0020	0.0020L
		+0.0005	-0.0030	0.0035L
76.200	101.600	0.000	-76	76L
3.0000	4.0000	+0.0000	-0.0030	0.0030L
		+0.0010	-0.0040	0.0050L
101.600	127.000	0.000	-102	102L
4.0000	5.0000	+0.0000	-0.0040	0.0040L
		+0.0010	-0.0050	0.0060L
127.000	152.400	0.000	-127	127L
5.0000	6.0000	+0.0000	-0.0050	0.0050L
		+0.0010	-0.0060	0.0070L
152.400	203.200	0.000	-152	152L
6.0000	8.0000	+0.0000	-0.0060	0.0060L
		+0.0010	-0.0070	0.0080L
203.200	304.800	0.000	-178	178L
8.0000	12.0000	+0.0000	-0.0070	0.0070L
		+0.0010	-0.0080	0.0090L
304.800	609.600	0.000	-203	203L
12.0000	24.0000	+0.0000	-0.0080	0.0080L
		+0.0020	-0.0100	0.0120L
609.600	914.400	0.000	-254	254L
24.0000	36.0000	+0.0000	-0.0100	0.0100L
		+0.0030	-0.0130	0.0160L
914.400	1219.200	0.000	-305	305L
36.0000	48.0000	+0.0000	-0.0120	0.0120L
		+0.0040	-0.0160	0.0200L
1219.200		0.000	-305	305L
48.0000		+0.0000	-0.0120	0.0120L
		+0.0050	-0.0170	0.0220L

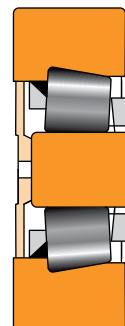

TTDFLK



TTDWK

NOTE

When one ring is piloted by the housing, sufficient clearances must be allowed at the outside diameter of the other ring as well as at the bore of both rings to prevent cross-loading of the rollers. For most applications, this clearance is approximately 1.588 mm (0.0625 in.).

**PRECISION CLASS TXR
TAPERED ROLLER BEARING FITS**

Tolerances for housing bore and shaft diameters are shown as variance from nominal bearing dimension.

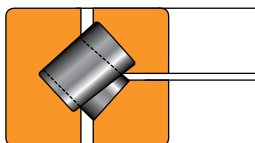

TXR

**TABLE 23. PRECISION CLASS TXR TAPERED ROLLER BEARINGS – SHAFT DIAMETER
TXR CLASSES S AND P (METRIC)**

Bearing Bore		Class S		Class P	
Range		Max.	Min.	Max.	Min.
Over	Incl.				
mm	mm	mm	mm	mm	mm
in.	in.	in.	in.	in.	in.
–	50.000	0.020T	0.007T	0.014T	0.004T
–	1.9685	0.0008T	0.0003T	0.0006T	0.0002T
50.000	80.000	0.025T	0.010T	0.017T	0.004T
1.9685	3.1496	0.0010T	0.0004T	0.0007T	0.0002T
80.000	120.000	0.033T	0.013T	0.017T	0.004T
3.1496	4.7244	0.0013T	0.0005T	0.0007T	0.0002T
120.000	180.000	0.052T	0.027T	0.017T	0.004T
4.7244	7.0866	0.0021T	0.0011T	0.0007T	0.0002T
180.000	250.000	0.060T	0.030T	0.020T	0.004T
7.0866	9.8425	0.0024T	0.0012T	0.0008T	0.0002T
250.000	315.000	0.070T	0.035T	0.022T	0.004T
9.8425	12.4016	0.0028T	0.0014T	0.0009T	0.0002T
315.000	400.000	0.077T	0.037T	0.024T	0.004T
12.4016	15.7480	0.0030T	0.0015T	0.0009T	0.0002T
400.000	500.000	0.085T	0.040T	0.030T	0.004T
15.7480	19.6850	0.0034T	0.0016T	0.0012T	0.0002T

**TABLE 24. PRECISION CLASS TXR TAPERED ROLLER BEARINGS – HOUSING BORE –
TXR CLASSES S AND P (METRIC)**

Bearing Bore		Class S		Class P	
Range		Max.	Min.	Max.	Min.
Over	Incl.				
mm	mm	mm	mm	mm	mm
in.	in.	in.	in.	in.	in.
–	50.000	0.020T	0.007T	0.014T	0.004T
–	1.9685	0.0008T	0.0003T	0.0006T	0.0002T
50.000	80.000	0.025T	0.010T	0.017T	0.004T
1.9685	3.1496	0.0010T	0.0004T	0.0007T	0.0002T
80.000	120.000	0.033T	0.013T	0.017T	0.004T
3.1496	4.7244	0.0013T	0.0005T	0.0007T	0.0002T
120.000	180.000	0.052T	0.027T	0.017T	0.004T
4.7244	7.0866	0.0021T	0.0011T	0.0007T	0.0002T
180.000	250.000	0.060T	0.030T	0.020T	0.004T
7.0866	9.8425	0.0024T	0.0012T	0.0008T	0.0002T
250.000	315.000	0.070T	0.035T	0.022T	0.004T
9.8425	12.4016	0.0028T	0.0014T	0.0009T	0.0002T
315.000	400.000	0.077T	0.037T	0.024T	0.004T
12.4016	15.7480	0.0030T	0.0015T	0.0009T	0.0002T
400.000	500.000	0.085T	0.040T	0.030T	0.004T
15.7480	19.6850	0.0034T	0.0016T	0.0012T	0.0002T

**TABLE 25. PRECISION CLASS TXR TAPERED ROLLER BEARINGS - SHAFT DIAMETER
TXR CLASSES 3 AND 0 (INCH)**

Bearing Bore		Class 3		Class 0	
Range		Max.	Min.	Max.	Min.
Over	Incl.				
mm	mm	mm	mm	mm	mm
in.	in.	in.	in.	in.	in.
–	304.800	0.037T	0.013T	0.020T	0.007T
–	12.0000	0.0015T	0.0005T	0.0008T	0.0003T
304.800	609.600	0.077T	0.025T	0.037T	0.013T
12.0000	24.0000	0.0030T	0.0010T	0.0015T	0.0005T
609.600	914.400	0.114T	0.037T	–	–
24.0000	36.0000	0.0045T	0.0015T	–	–
914.400	1219.200	0.152T	0.051T	–	–
36.0000	48.0000	0.0060T	0.0020T	–	–
1219.200	–	0.191T	0.064T	–	–
48.0000	–	0.0075T	0.0025T	–	–

**TABLE 26. PRECISION CLASS TXR TAPERED ROLLER BEARINGS - HOUSING BORE
TXR CLASSES 3 AND 0 (INCH)**

Bearing Bore		Class 3		Class 0	
Range		Max.	Min.	Max.	Min.
Over	Incl.				
mm	mm	mm	mm	mm	mm
in.	in.	in.	in.	in.	in.
–	304.800	0.037T	0.013T	0.020T	0.007T
–	12.0000	0.0015T	0.0005T	0.0008T	0.0003T
304.800	609.600	0.077T	0.025T	0.037T	0.013T
12.0000	24.0000	0.0030T	0.0010T	0.0015T	0.0005T
609.600	914.400	0.114T	0.037T	–	–
24.0000	36.0000	0.0045T	0.0015T	–	–
914.400	1219.200	0.152T	0.051T	–	–
36.0000	48.0000	0.0060T	0.0020T	–	–
1219.200	–	0.191T	0.064T	–	–
48.0000	–	0.0075T	0.0025T	–	–

SETTING

Thrust bearings are typically set up against another bearing with the setting determined by the application requirements. Most thrust bearings operate under a preload condition.

Correct bearing mounting and fitting practices are key components of proper bearing setting.

INSTALLATION

Proper bearing installation, including cleanliness of the components, as well as use of proper tools, is critical to bearing performance.

Cleanliness of the bearing and mating components is essential for a bearing to achieve maximum service life. Burrs, foreign material and any raised portions of the components mating with the bearing can cause misalignment. Care should be taken to avoid these conditions. Shafts and housings, including lubrication holes, should be thoroughly cleaned before bearing installation. If blind holes are present, insert a magnetic rod to remove metal chips that might have accumulated during manufacture. An air hose may be used on shafts and housings, but should not be used on bearings. Bearings in their shipping containers are typically coated with a rust-inhibitive oil. This oil is compatible with most lubricants and does not need to be removed prior to installation.

Adequate tools must be used to properly fit the inner rings onto the shaft and outer rings into the housing to avoid damage. Direct impact on the rings must be avoided. Inspection of fillets and undercuts should be completed prior to assembly to ensure proper clearance with the bearing.

If applications require a tight interference fit of one or both rings, it is acceptable to heat or cool rings to ease assembly. Standard bearings should not be heated above 120° C (250° F) or cooled below -55° C (-65° F). Precision bearings should not be heated above 65° C (150° F) or cooled below -30° C (-20° F). An alternate method of mounting, generally used on smaller sizes, is to press the bearing onto the shaft or into the housing using an arbor press.

For more information on these installation procedures, please contact your Timken engineer.

 <p>WARNING</p> <p><i>Failure to observe the following warnings could create a risk of death or serious injury.</i></p>
<p>Never spin a bearing with compressed air. The components may be forcefully expelled.</p> <p>Proper maintenance and handling practices are critical. Always follow installation instructions and maintain proper lubrication.</p>

 <p>WARNING</p> <p><i>Failure to observe the following warnings could create a risk of death or serious injury.</i></p>
<p>Proper maintenance and handling practices are critical. Always follow installation instructions and maintain proper lubrication.</p> <p>Overheated bearings can ignite explosive atmospheres. Special care must be taken to properly select, install, maintain, and lubricate housed unit bearings that are used in or near atmospheres that may contain explosive levels of combustible gases or accumulations of dust such as from grain, coal, or other combustible materials.</p> <p>Consult your equipment designer or supplier for installation and maintenance instructions.</p>

NOTE:

The products cataloged are application specific. Any use in applications other than those intended could lead to equipment failure or to reduced equipment life.

Use of improper bearing fits may cause damage to equipment.

Do not use damaged bearings. The use of a damaged bearing can result in equipment damage.

BEARING OPERATION

OPERATING TEMPERATURES

Bearings operate in a wide range of applications and environments. In most cases, bearing operating temperature is not an issue. Some applications, however, operate at extreme speeds or in extreme temperature environments. In these cases, care must be taken not to exceed the temperature limits of the bearing. Minimum temperature limits are primarily based on lubricant capability. Maximum temperature limits are most often based on material and/or lubricant constraints, but also may be based on accuracy requirements of the equipment that the bearings are built into. These constraints/limitations are discussed below.

BEARING MATERIAL LIMITATIONS

Standard bearing steels with a standard heat treatment cannot maintain a minimum hardness of 58 HRC much above 120° C (250° F).

Dimensional stability of Timken bearings is managed through the proper selection of an appropriate heat-treat process. Standard Timken ball bearings are dimensionally stabilized from -54° C (-65° F) up to 120° C (250° F). Upon request, these bearings can be ordered to higher levels of stability as listed below. These designations are in agreement with DIN Standard 623.

TABLE 27.

Stability Designation	Maximum Operating Temperature	
	°C	°F
S0	150	302
S1	200	392
S2	250	482
S3	300	572
S4	350	662

With dimensionally stabilized product, there still may be some changes in dimensions during service as a result of microstructural transformations. These transformations include the continued tempering of martensite and decomposition of retained austenite. The magnitude of change depends on the operating temperature, the time at temperature and the composition and heat-treatment of the steel.

Temperatures exceeding the limits shown in table 27 require special high-temperature steel. Consult your Timken engineer for availability of specific part numbers for non-standard heat stability or high-temperature steel grades.

Suggested materials for use in balls, rings and rollers at various operating temperatures are listed in table 28. Also listed are chemical composition suggestions, hardness suggestions and dimensional stability information.

Operating temperature affects lubricant film thickness and setting, both of which directly influence bearing life. Extremely high temperatures can result in a reduced film thickness that can lead to asperity contact between contacting surfaces.

Operating temperature also can affect performance of cages, seals and shields, which in turn can affect bearing performance. Materials for these components and their operating temperature ranges are shown in table 28.

LUBRICATION LIMITATIONS

Starting torque in grease-lubricated applications typically increases significantly at cold temperatures. Starting torque is not primarily a function of the consistency or channel properties of the grease. Most often, it is a function of the rheological properties of the grease.

The high-temperature limit for greases is generally a function of the thermal and oxidation stability of the base oil in the grease and the effectiveness of the oxidation inhibitors.

See the LUBRICATION section on page 55 for more information on lubrication limitations.

EQUIPMENT REQUIREMENTS

The equipment designer must evaluate the effects of temperature on the performance of the equipment being designed. Precision machine tool spindles, for example, can be very sensitive to thermal expansions. For some spindles, it is important that the temperature rise over ambient be held to 20° C to 35° C (36° F to 45° F).

Most industrial equipment can operate at considerably higher temperatures. Thermal ratings on gear drives, for example, are based on 93° C (200° F). Equipment such as gas turbines operates continuously at temperatures above 100° C (212° F). Running at high temperatures for extended periods of time, however, may affect shaft and housing fits if the shaft and housing are not machined and heat-treated properly.

Although bearings can operate satisfactorily up to 120° C (250° F), an upper temperature limit of 80° C to 95° C (176° F to 203° F) is more practical. Higher operating temperatures increase the risk of damage from transient temperature spikes. Prototype testing of the application can help define the operating temperature range and should be conducted if possible. It is the responsibility of the equipment designer to weigh all relevant factors and make the final determination of satisfactory operating temperature.

Table 28 provides standard operating temperatures for common bearing component materials. They should be used for reference purposes only. Other bearing component materials are available on request. Contact your Timken engineer for more information.

TABLE 28. OPERATING TEMPERATURES FOR BEARING COMPONENT MATERIALS

Material	Approximate Chemical Analysis %	Temp. °F	Hardness HRC	-73° C	-54° C	-17° C	38° C	93° C	121° C	149° C	204° C	260° C	316° C	371° C	427° C
				-100° F	-65° F	0° F	100° F	200° F	250° F	300° F	400° F	500° F	600° F	700° F	800° F
Low-alloy carbon-chromium bearing steels. 52100 and others per ASTM A295	1C 0.5-1.5Cr 0.35Mn	70	60	STANDARD DIMENSIONAL STABILIZATION <0.0001 in./in dimensional change in 2500 hours at 100° C (212° F). Good oxidation resistance.											
Low-alloy carbon-chromium bearing steels. 52100 and others per ASTM A295	1C 0.5-1.5Cr 0.35Mn	70 350 450	58 56 54	Heat stabilized <0.0001 in./in dimensional change in 2500 hours at 149° C (300° F). When given a stabilizing heat treatment, A295 steel is suitable for many applications in the 177°-232° C (350-450° F) range; however, it is not as dimensionally stable as it is at temperatures below 177° C (350° F). If utmost stability is required, use materials in the 316° C (600° F) group below.											
Deep-hardening steels for heavy sections per ASTM A485	1C 1-1.8Cr 1-1.5Mn .06Si	70 450 600	58 55 52	As heat-treated and tempered, it is stabilized, <0.0001 in./in dimensional change in 2500 hours at 149° C (300° F).											
Carburizing steels per ASTM A534 a) low alloy 4118, 8X19, 5019, 8620 (Ni-Moly grades) b) high nickel 3310	Ni-Moly: 0.2C, 0.4-2.0Mn, 0.3-0.8Cr, 0-2.0Ni, 0-0.3Mo .01C, 1.5Cr, 0.4Mn, 3.5Ni	70	58	Nickel-Moly grades of steel frequently used to achieve extra ductility in inner rings for locking device bearings. 3311 and others used for extra-thick-section rings.											
Corrosion-resistant 440C stainless steel per ASTM A756	1C 18Cr	70	58	Excellent corrosion resistance.											
Corrosion-resistant 440C stainless steel per ASTM A756	1C 18Cr	70 450 600	58 55 52	As heat stabilized for maximum hardness at high temperatures. Good oxidation resistance at higher temperatures. Note load capacity drops off more rapidly at higher temperatures than M50 shown below, which should be considered if loads are high, <0.0001 in./in dimensional change in 1200 hours.											
M-50 medium high speed	4Cr 4Mo 1V 0.8C	70 450 600	60 59 57	Suggested where stable high hardness at elevated temperature is required, <0.0001 in./in dimensional change in 1200 hours at 316° C (600° F).											

NOTE: Dimensional stability data shown above is the permanent metallurgical growth and/or shrinkage only. Thermal expansion effects are not included. For operating temperatures above 427° C (800° F), consult your Timken engineer.

HEAT GENERATION AND DISSIPATION

Bearing operating temperature is dependent upon a number of factors, including heat generation of all contributing heat sources, heat flow rate between sources and the ability of the system to dissipate the heat. Heat sources include such things as bearings, seals, gears, clutches and oil supply. Heat dissipation is affected by many factors, including shaft and housing materials and designs, lubricant circulation and external environmental conditions. These and other factors are discussed in the following sections.

HEAT GENERATION

Under normal operating conditions, most of the torque and heat generated by the bearing is caused by the elastohydrodynamic losses at the roller/ring contacts.

Heat generation is the product of bearing torque (M) and speed (n). The following equation is used to calculate the heat generated.

$$Q_{\text{gen}} = k_4 n M$$

Where:

$$\begin{aligned} k_4 &= 0.105 \text{ for } Q_{\text{gen}} \text{ in W when } M \text{ in N-m} \\ &= 6.73 \times 10^{-4} \text{ for } Q_{\text{gen}} \text{ in Btu/min when } M \text{ in lbf-in.} \end{aligned}$$

If the bearing is tapered, the torque can be calculated using the following equation.

$$M = k_1 G_1 (n\mu)^{0.5} (F_a)^{0.3}$$

Where:

$$\begin{aligned} k_1 &= \text{bearing torque constant} \\ &= 7.97 \times 10^{-6} \text{ for } M \text{ in N-m} \\ &= 1.1 \times 10^{-4} \text{ for } M \text{ in lbf-in.} \\ F_a &= \text{thrust load} \\ \mu &= \text{lubricant viscosity} \\ G_1 &= \text{bearing geometry factor} \\ &\text{(Part-specific; please contact your Timken} \\ &\text{representative.)} \end{aligned}$$

For thrust cylindrical and spherical roller bearings, the torque equations are given as follows, where the coefficients are based on series and found table 29:

$$M = \left\{ \begin{array}{l} f_1 F_a dm + 10^{-7} f_0 (v \times n)^{2/3} dm^3 \text{ if } (v \times n) \geq 2000 \\ f_1 F_a dm + 160 \times 10^{-7} f_0 dm^3 \text{ if } (v \times n) < 2000 \end{array} \right\}$$

Note that the viscosity is in units of centistokes and dm is the mean bearing diameter.

TABLE 29. COEFFICIENTS FOR THE TORQUE EQUATION

Bearing Type	Dimension Series	f_0	f_1
Thrust cylindrical roller bearings	11	3	0.00150
	12	4	0.00150
Thrust spherical roller bearings	92	2.5	0.00023
	93	2.5	0.00023
	94	3	0.00030

HEAT DISSIPATION

The problem of determining the heat flow from a bearing in a specific application is rather complex. In general, it can be said that factors affecting the rate of heat dissipation include the following:

1. Temperature gradient from the bearing to the housing. This is affected by size configuration of the house and any external cooling such as fans, water cooling or fan action of the rotating components.
2. Temperature gradient from the bearing to the shaft. Any other heat sources, such as gears and additional bearings and their proximity to the bearing considered, will influence the temperature of the shaft.
3. The heat carried away by a circulating oil system.

To what extent nos. 1 and 2 can be controlled will depend on the application. The heat-dissipation modes include conduction through the system, convection along the inside and outside surfaces of the system, as well as radiation exchange to and from neighboring structures. In many applications, overall heat dissipation can be divided into two categories – heat removed by circulating oil and heat removed through the structure.

Heat dissipation by circulating oil

The amount of heat removed by the lubricant can be controlled more easily. In a splash lubrication system, cooling coils may be used to control the bulk oil temperature.

The amount of heat carried away in a circulating oil system by the lubricant can be approximated from the following equations.

$$Q_{oil} = 1.67 \times 10^{-5} v C_p \rho (\theta_o - \theta_i)$$

Where:

V = oil flow rate (L/min)

C_p = Specific Heat of Lubricant (J/(kg- °C))

ρ = lubricant density (kg/m³)

θ_i = oil inlet temperature

θ_o = oil outlet temperature

DISCLAIMER

If a more thorough knowledge of bearing torque, power losses and system temperatures is needed, contact your Timken representative.

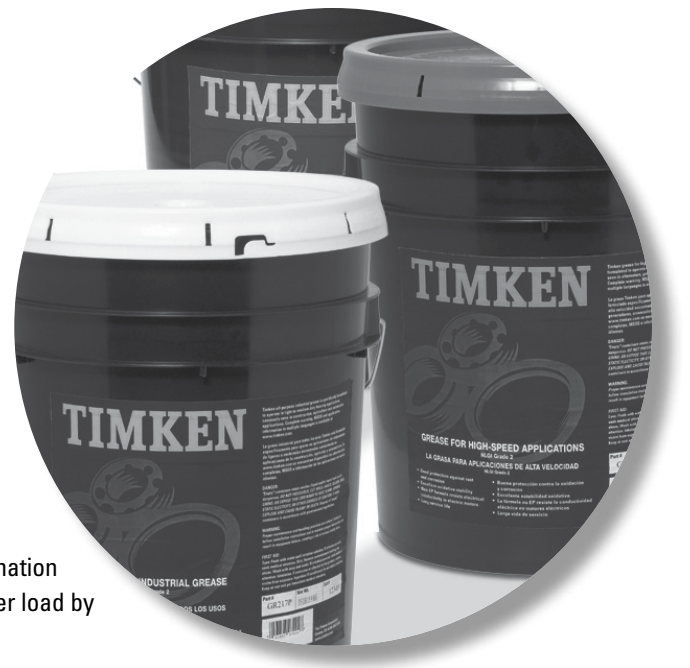

LUBRICATION

To help maintain a bearing's antifriction characteristics, lubrication is needed to:

- Minimize rolling resistance due to deformation of the rolling elements and raceway under load by separating the mating surfaces.
- Minimize sliding friction occurring between rolling elements, raceways and cage.
- Transfer heat (with oil lubrication).
- Protect from corrosion and, with grease lubrication, from contaminant ingress.

LUBRICATION

The wide range of bearing types and operating conditions precludes any simple, all-inclusive statement or guideline for selecting the proper lubricant. At the design level, the first consideration is whether oil or grease is best for the particular operation. The advantages of oil and grease are outlined in table 30. When heat must be carried away from the bearing, oil must be used. Oil is almost always preferred for very high-speed applications.

TABLE 30. ADVANTAGES OF OIL AND GREASE

Oil	Grease
Carries heat away from the bearings	Simplifies seal design and acts as a sealant
Carries away moisture and particulate matter	Permits prelubrication of sealed or shielded bearings
Easily controlled lubrication	Generally requires less frequent lubrication

European REACH compliance

Timken-branded lubricants, greases and similar products sold in stand-alone containers or delivery systems are subject to the European REACH (**R**egistration, **E**valuation, **A**uthorization and **R**estriction of **C**hemicals) directive. For import into the European Union, Timken can sell and provide only those lubricants and greases that are registered with ECHA (European Chemical Agency). For further information, please contact your Timken engineer.

OIL LUBRICATION

Oils used for bearing lubrication should be high-quality mineral oils or synthetic oils with similar properties. Selection of the proper type of oil depends on bearing speed, load, operating temperature and lubrication method. In addition to the above, some features and advantages of oil lubrication are:

- Oil is a better lubricant for high speeds or high temperatures. It can be cooled to help reduce bearing temperature.
- It is easier to handle and control the amount of lubricant reaching the bearing. It is harder to retain in the bearing. Lubricant losses may be higher than with grease.
- Oil can be introduced to the bearing in many ways, such as drip-feed, wick-feed, pressurized circulating systems, oil bath or air-oil mist. Each is suited for certain types of applications.
- Oil is easier to keep clean for recirculating systems.

Oil may be introduced to the bearing housing in many ways. The most common systems are:

- **Oil bath.** The housing is designed to provide a sump through which the rolling elements of the bearing will pass. Generally, the oil level should be no higher than the center point of the lowest rolling element. If speed is high, lower oil levels should be used to reduce churning. Gages or controlled elevation drains are used to achieve and maintain the proper oil level.
- **Circulating system.** This system has the advantages of:
 - An adequate supply of oil for both cooling and lubrication.
 - Metered control of the quantity of oil delivered to each bearing.
 - Removal of contaminants and moisture from the bearing by flushing action.
 - Suitability for multiple bearing installations.
 - Large reservoir, which reduces deterioration.
 - Increased lubricant life provides economical efficiency.
 - Incorporation of oil-filtering devices.
 - Positive control to deliver the lubricant where needed.
 - A typical circulating oil system consists of an oil reservoir, pump, piping and filter. A heat exchange may be required.
- **Oil-mist lubrication.** Oil-mist lubrication systems are used in high-speed, continuous-operation applications. This system permits close control of the amount of lubricant reaching the bearings. The oil may be metered, atomized by compressed air and mixed with air, or picked up from a reservoir using a venturi effect. In either case, the air is filtered and supplied under sufficient pressure to ensure adequate lubrication of the bearings. Control of this type of lubrication system is accomplished by monitoring the operating temperatures of the bearings being lubricated. The continuous passage of the pressurized air and oil through the labyrinth seals used in the system prevents the entrance of contaminants from the atmosphere to the system.

The successful operation of this type of system is based upon the following factors:

 - Proper location of the lubricant entry ports in relation to the bearings being lubricated.
 - Avoidance of excessive pressure drops across void spaces within the system.

- Proper air pressure and oil quantity ratio to suit the particular application.
- Adequate exhaust of the air-oil mist after lubrication has been accomplished.

To ensure “wetting” of the bearings, and to prevent possible damage to the rolling elements and rings, it is imperative that the oil-mist system be turned on for several minutes before the equipment is started. The importance of “wetting” the bearing before starting cannot be overstated, and it also has particular significance for equipment that has been idled for extended periods of time.

Lubricating oils are commercially available in many forms for automotive, industrial, aircraft and other uses. Oils are classified as either petroleum types (refined from crude oil) or synthetic types (produced by chemical synthesis).

PETROLEUM OILS

Petroleum oils are made from a petroleum hydrocarbon derived from crude oil, with additives to improve certain properties. Petroleum oils are used for nearly all oil-lubricated applications of bearings.

SYNTHETIC OILS

Synthetic oils cover a broad range of categories and include polyalphaolefins, silicones, polyglycols and various esters. In general, synthetic oils are less prone to oxidation and can operate at extreme hot or cold temperatures. Physical properties, such as pressure-viscosity coefficients, tend to vary between oil types; use caution when making oil selections.

The polyalphaolefins (PAO) have a hydrocarbon chemistry that parallels petroleum oil both in chemical structures and pressure-viscosity coefficients. Therefore, PAO oil is mostly used in the oil-lubricated applications of bearings when severe temperature environments (hot and cold) are encountered or when extended lubricant life is required.

The silicone, ester and polyglycol oils have an oxygen-based chemistry that is structurally quite different from petroleum oils and PAO oils. This difference has a profound effect on its physical properties where pressure-viscosity coefficients can be lower compared to mineral and PAO oils. This means that these types of synthetic oils may actually generate a smaller elastohydrodynamic (EHD) film thickness than a mineral or PAO oil of equal viscosity at operating temperature. Reductions in bearing fatigue life and increases in bearing wear could result from this reduction of lubricant film thickness.

VISCOSITY

The selection of oil viscosity for any bearing application requires consideration of several factors: load, speed, bearing setting, type of oil and environmental factors. Since oil viscosity varies inversely with temperature, a viscosity value must always be stated with the temperature at which it was determined. High-viscosity oil is used for low-speed or high-ambient-temperature applications. Low-viscosity oil is used for high-speed or low-ambient-temperature applications.

There are several classifications of oils based on viscosity grades. The most familiar are the Society of Automotive Engineers (SAE) classifications for automotive engine and gear oils. The American Society for Testing and Materials (ASTM) and the International Organization for Standardization (ISO) have adopted standard viscosity grades for industrial fluids. Fig. 49 shows the viscosity comparisons of ISO/ASTM with SAE classification systems at 40° C (104° F).

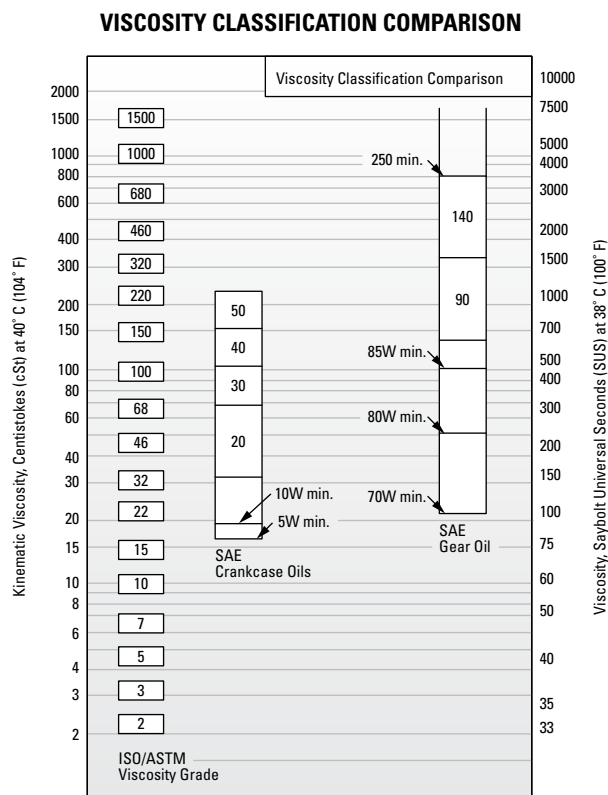

Fig. 49. Comparison between ISO/ASTM grades (ISO 3448/ASTM D2442) and SAE grades (SAE J 300-80 for crankcase oils, SAE J 306-81 for axle and manual transmission oils).

The ASTM/ISO viscosity grade system for industrial oils is depicted below.

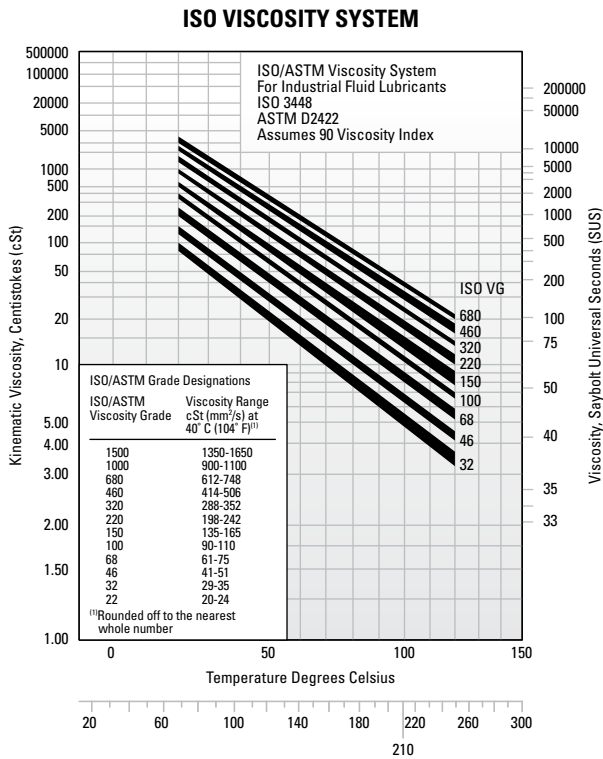

Fig. 50. Viscosity grade system for industrial oils.

TYPICAL BEARING LUBRICATION OILS

In this section, the properties and characteristics of lubricants for typical roller bearing applications are listed. These general characteristics are derived from successful performance in applications across all industries.

General-purpose rust and oxidation lubricating oil

General-purpose rust and oxidation (R&O) inhibited oils are the most common type of industrial lubricant. They are used to lubricate Timken® bearings in all types of industrial applications where conditions requiring special considerations do not exist.

TABLE 31. SUGGESTED GENERAL PURPOSE R&O LUBRICATING OIL PROPERTIES

Properties	
Base stock	Solvent-refined, high-viscosity-index petroleum oil
Additives	Corrosion and oxidation inhibitors
Viscosity index	80 min.
Pour point	-10° C max. (14° F)
Viscosity grades	ISO/ASTM 32 through 220

Some low-speed and/or high-ambient-temperature applications require the higher viscosity grades. High-speed and/or low-temperature applications require the lower viscosity grades.

Industrial extreme-pressure (EP) gear oil

Extreme-pressure gear oils are used to lubricate Timken bearings in most types of heavily loaded industrial equipment. They should be capable of withstanding abnormal shock loads that are common in heavy-duty equipment.

TABLE 32. SUGGESTED INDUSTRIAL EP GEAR OIL PROPERTIES

Properties	
Base stock	Solvent-refined, high-viscosity-index petroleum oil
Additives	Corrosion and oxidation inhibitors Extreme-pressure (EP) additive ⁽¹⁾ - 15.8 kg (35 lb.) min.
Viscosity index	80 min.
Pour point	-10° C max. (14° F)
Viscosity grades	ISO/ASTM 100, 150, 220, 320, 460

⁽¹⁾ ASTM D 2782

Industrial EP gear oils should be composed of a highly refined petroleum oil-based stock plus appropriate inhibitors and additives. They should not contain materials that are corrosive or abrasive to bearings. The inhibitors should provide long-term protection from oxidation and protect the bearing from corrosion in the presence of moisture. The oils should resist foaming in service and have good water-separation properties. An EP additive protects against scoring under boundary-lubrication conditions. The viscosity grades suggested represent a wide range. High-temperature and/or slow-speed applications generally require the higher viscosity grades. Low temperatures and/or high speeds require the use of lower viscosity grades.

GREASE LUBRICATION

Grease lubrication is generally applicable to low-to-moderate speed applications that have operating temperatures within the limits of the grease. There is no universal antifriction bearing grease. Each grease has limiting properties and characteristics.

Greases consist of a base oil, a thickening agent and additives. Conventionally, bearing greases have consisted of petroleum base oils thickened to the desired consistency by some form of metallic soap. More recently synthetic base oils have been used with organic and inorganic thickeners. Table 33 summarizes the composition of typical lubricating greases.

TABLE 33. COMPOSITION OF GREASES

Base Oil	+	Thickening Agents	+	Additives	=	Lubricating Grease
Mineral oil		Soaps and complex soaps		Rust inhibitors		
Synthetic hydrocarbon		lithium, aluminum, barium, calcium		Dyes		
Esters		Non-Soap (inorganic)		Tactifiers		
Perfluorinated oil		microgel (clay), carbon black,		Metal deactivates		
Silicone		silica-gel, PTFE		Oxidation inhibitors		
		Non-Soap (organic)		Anti-wear EP		
		Polyurea compounds				

Calcium- and aluminum-based greases have excellent water resistance and are used in industrial applications where water ingress is an issue. Lithium-based greases are multi-purpose and are used in industrial applications and wheel bearings.

Synthetic-based oils such as esters, organic esters and silicones used with conventional thickeners and additives typically have higher maximum operating temperatures than petroleum-based greases. Synthetic greases can be designed to operate in temperatures from -73° C (-100° F) to 288° C (550° F).

Below are the general characteristics of common thickeners used with petroleum base oils.

TABLE 34. GENERAL CHARACTERISTICS OF THICKENERS USED WITH PETROLEUM BASE OILS

Thickener	Typical Dropping Point		Maximum Temperature		Typical Water Resistance
	°C	°F	°C	°F	
Lithium soap	193	380	121	250	Good
Lithium complex	260+	500+	149	300	Good
Aluminum complex	249	480	149	300	Excellent
Calcium sulfonate	299	570	177	350	Excellent
Polyurea	260	500	149	300	Good

Use of the thickeners in table 34 with synthetic hydrocarbon or ester base oils increases the maximum operating temperature by approximately 10° C (50° F).

Using polyurea as a thickener for lubricating fluids is one of the most significant lubrication developments in more than 30 years. Polyurea grease performance is outstanding in a wide range of bearing applications and, in a relatively short time, it has gained acceptance as a factory-packed lubricant for ball bearings.

LOW TEMPERATURES

Starting torque in a grease-lubricated bearing at low temperatures can be critical. Some greases may function adequately as long as the bearing is operating, but resistance to initial movement may be excessive. In certain smaller machines, starting may be impossible when very cold. Under such operating circumstances, greases containing low-temperature characteristic oils are generally required.

If the operating temperature range is wide, synthetic greases offer advantages. Synthetic greases are available to provide very low starting and running torque at temperatures as low as -73° C (-100° F). In certain instances, these greases perform better in this respect than oil.

An important point concerning lubricating greases is that the starting torque is not necessarily a function of the consistency or the channel properties of the grease. Starting torque is more a function of the individual rheological properties of a particular grease and is best evaluated by application experience.

HIGH TEMPERATURES

The high temperature limit for lubricating greases is generally a function of the thermal and oxidation stability of the fluid and the effectiveness of the oxidation inhibitors. Grease temperature ranges are defined by both the dropping point of the grease thickener and composition of the base oil. Table 35 shows the temperature ranges of various base oils used in grease formulations.

A rule of thumb, developed from years of testing grease-lubricated bearings, indicates that grease life is halved for every 10° C (50° F) increase in temperature. For example, if a particular grease provides 2000 hours of life at 90° C (194° F), by raising the temperature to 100° C (212° F), reduction in life to approximately 1000 hours would result. On the other hand, 4000 hours could be expected by lowering the temperature to 80° C (176° F).

Thermal stability, oxidation resistance and temperature limitations must be considered when selecting greases for high-temperature applications. In non-relubricatable applications, highly refined mineral oils or chemically stable synthetic fluids are required as the oil component of greases for operation at temperatures above 121° C (250° F).

TABLE 35. TEMPERATURE RANGES FOR BASE OILS USED IN LUBRICATING GREASES

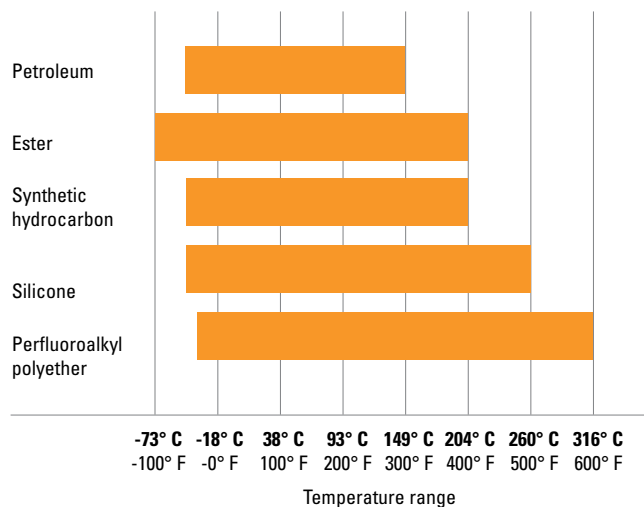

CONTAMINATION

Abrasive Particles

When roller bearings operate in a clean environment, the primary cause of damage is the eventual fatigue of the surfaces where rolling contact occurs. However, when particle contamination enters the bearing system, it is likely to cause damage such as bruising, which can shorten bearing life.

When dirt from the environment or metallic wear debris from some component in the application is allowed to contaminate the lubricant, wear can become the predominant cause of bearing damage. If bearing wear becomes significant, changes will occur to critical bearing dimensions that could adversely affect machine operation.

Bearings operating in a contaminated lubricant exhibit a higher initial rate of wear than those running in an uncontaminated lubricant. With no further contaminant ingress, this wear rate quickly diminishes. The contamination particles are reduced in size as they pass through the bearing contact area during normal operation.

Water

Water and moisture can be particularly conducive to bearing damage. Lubricating greases may provide a measure of protection from this contamination. Certain greases, such as calcium and aluminum-complex, are highly water-resistant.

Sodium-soap greases are water-soluble and should not be used in applications involving water.

Dissolved or suspended water in lubricating oils can exert a detrimental influence on bearing fatigue life. Water can cause bearing etching that also can reduce bearing fatigue life. The exact mechanism by which water lowers fatigue life is not fully understood. It has been suggested that water enters micro-cracks in the bearing rings that are caused by repeated stress cycles. This leads to corrosion and hydrogen embrittlement in the micro-cracks, reducing the time required for these cracks to propagate to an unacceptable-sized spall.

Water-based fluids, such as water glycol and invert emulsions, also have shown a reduction in bearing fatigue life. Although water from these sources is not the same as contamination, the results support the previous discussion concerning water-contaminated lubricants.

GREASE SELECTION

The successful use of bearing grease depends on the physical and chemical properties of the lubricant as well as application and environmental conditions. Because the choice of grease for a particular bearing under certain service conditions is often difficult to make, you should consult with your lubricant supplier or equipment maker for specific questions about lubrication requirements for your application. You also can contact your Timken engineer for general lubrication guidelines for any application.

Grease must be carefully selected with regard to its consistency at operating temperature. It should not exhibit thickening, separation of oil, acid formation or hardening to any marked degree. It should be smooth, non-fibrous and entirely free from chemically active ingredients. Its dropping point should be considerably higher than the operating temperature.

Timken® application-specific lubricants were developed by leveraging our knowledge of tribology and anti-friction bearings, and how these two elements affect overall system performance. Timken® lubricants help bearings and related components operate effectively in demanding industrial operations. High-temperature, anti-wear and water-resistant additives offer superior protection in challenging environments. Table 36 provides an overview of the Timken greases available for general applications. Contact your Timken engineer for a more detailed publication on Timken® lubrication solutions.

TABLE 36. GREASE LUBRICATION SELECTION GUIDE

ENVIRONMENT		APPLICATION
High Wear • Moderate Loads Moderate Speeds Moderate Temperatures	→	←
	Timken Premium All-Purpose Industrial Grease	Agriculture • Bushings/Ball Joints Truck and Auto Wheel Bearings Heavy-Duty Industrial
Extreme Heat • Heavy Loads High Sliding Wear Dirty Environments Slow Speeds • Shock Loading	→	←
	Timken Construction and Off-Highway Grease	Agriculture/Mining • Cement Plants Construction/Off Road • Rock Quarry Earth-Moving Equipment Fleet Equipment • Heavy Industry Pivot Pins/Splined Shafts
Wet and Corrosive Conditions Quiet Environments • Light Loads Moderate to High Speeds Moderate Temperatures Light Load Moderate Water	→	←
	Timken Ball Bearing Pillow Block Grease	Lightly Loaded Pillow Blocks Idler Pulleys • Oven Conveyors Electric Motors • Fans • Pumps Alternators • Generators
Corrosive Media • Extreme Heat Heavy Loads • Wet Conditions Slow to Moderate Speeds	→	←
	Timken Mill Grease	Aluminum Mills • Paper Mills Steel Mills • Offshore Rigs Power Generation
Incidental Food Contact Hot and Cold Temperatures Moderate to High Speeds Medium Loads	→	←
	Timken Food Safe Grease	Food and Beverage Industries Pharmaceuticals
Extreme Low and High Temperatures Severe Loads Corrosive Media Slow to Moderate Speeds	→	←
	Timken Synthetic Industrial Grease	Wind Energy Main Bearing Pulp and Paper Machines General Heavy Industry Marine Applications Centralized Grease Systems
Moderate Speeds Light to Moderate Loads Moderate Temperatures Moderate Water	→	←
	Timken Multi-Use Lithium Grease	General Industrial Applications Pins and Bushings • Track Rollers Water Pumps Plain and Anti-Friction Bearings

This selection guide is not intended to replace the specifications by the equipment builder, who is responsible for its performance.

Many bearing applications require lubricants with special properties or lubricants formulated specifically for certain environments, such as:

- Friction oxidation (fretting corrosion).
- Chemical and solvent resistance.
- Food handling.
- Quiet running.
- Space and/or vacuum.
- Electrical conductivity.

For assistance with these or other areas requiring special lubricants, consult your Timken engineer.

GREASE USE GUIDELINES

It is important to use the proper amount of grease in the application. In typical industrial applications, the bearing cavity should be kept approximately one-third to one-half full. Less grease may result in the bearing being starved for lubrication. More grease may result in churning. Both conditions may result in excessive temperature. As the grease temperature rises, viscosity decreases and the grease becomes thinner. This can reduce the lubricating effect and increase leakage of the grease from the bearing. It also may cause the grease components to separate, leading to a general breakdown of the lubricant properties. As the grease breaks down, bearing torque increases. In the case of excess grease resulting in churning, torque may also increase due to the resistance caused by the grease.

For best results, there should be ample space in the housing to allow room for excess grease to be thrown from the bearing. However, it is equally important that the grease be retained all around the bearing. If a large void exists between the bearings, grease closures should be used to prevent the grease from leaving the bearing area.

Only in low-speed applications may the housing be entirely filled with grease. This method of lubrication is a safeguard against the entry of foreign matter, where sealing provisions are inadequate for exclusion of contaminants or moisture.

During periods of non-operation, it is often wise to completely fill the housings with grease to protect the bearing surfaces. Prior to restarting operation, remove the excess grease and restore the proper level.

Applications utilizing grease lubrication should have a grease fitting and a vent at opposite ends of the housing near the top. A drain plug should be located near the bottom of the housing to allow the old grease to purge from the bearing.

Bearings should be relubricated at regular intervals to prevent damage. Relubrication intervals are difficult to determine. If plant practice or experience with other applications is not available, consult your lubricant supplier.

Timken offers a range of lubricants to help bearings and related components operate effectively in demanding industrial operations. High-temperature, anti-wear and water-resistant additives offer greater protection in challenging environments. Timken also offers a line of single- and multi-point lubricators to simplify grease delivery.



Fig. 51. Grease can easily be packed by hand.



Fig. 52. Mechanical grease packer.

Grease application methods

Grease, in general, is easier to use than oil in industrial bearing lubrication applications. Most bearings that are initially packed with grease require periodic relubrication to operate efficiently.

Grease should be packed into the bearing so that it gets between the rolling elements – the rollers or balls. For tapered roller bearings, forcing grease through the bearing from the large end to the small end will ensure proper distribution.

Grease can be easily packed into small- and medium-size bearings by hand (fig. 51). In shops where bearings are frequently regreased, a mechanical grease packer that forces grease through the bearing under pressure may be appropriate (fig. 52). Regardless of the method, after packing the internal areas of the bearing, a small amount of grease also should be smeared on the outside of the rollers or balls.

The two primary considerations that determine the relubrication cycle are operating temperature and sealing efficiency. High-operating-temperature applications generally require more frequent regreasing. The less efficient the seals, the greater the grease loss and the more frequently grease must be added.

Grease should be added any time the amount in the bearing falls below the desired amount. The grease should be replaced when its lubrication properties have been reduced through contamination, high temperature, water, oxidation or any other factors. For additional information on appropriate regreasing cycles, consult with the equipment manufacturer or your Timken engineer.

CONSISTENCY

Greases may vary in consistency from semi-fluids that are hardly thicker than a viscous oil to solid grades almost as hard as a soft wood.

Consistency is measured by a penetrometer in which a standard weighted cone is dropped into the grease. The distance the cone penetrates (measured in tenths of a millimeter in a specific time) is the penetration number.

The National Lubricating Grease Institute (NLGI) classification of grease consistency is shown below:

TABLE 37. NLGI CLASSIFICATIONS

NLGI Grease Grades	Penetration Number
0	355-385
1	310-340
2	265-295
3	220-250
4	175-205
5	130-160
6	85-115

Grease consistency is not fixed; it normally becomes softer when sheared or “worked.” In the laboratory, this “working” is accomplished by forcing a perforated plate up and down through a closed container of grease. This “working” does not compare with the violent shearing action that takes place in a bearing and does not necessarily correlate with actual performance.

TABLE 38. GREASE COMPATIBILITY CHART

	Al Complex	Ba Complex	Ca Stearate	Ca 12 Hydroxy	Ca Complex	Ca Sulfonate	Clay Non-Soap	Li Stearate	Li 12 Hydroxy	Li Complex	Polyurea	Polyurea S S
Aluminum Complex	Best Choice	Incompatible	Incompatible	Compatible	Incompatible	Borderline	Incompatible	Incompatible	Incompatible	Compatible	Incompatible	Compatible
Timken Food Safe	Best Choice	Incompatible	Incompatible	Compatible	Incompatible	Borderline	Incompatible	Incompatible	Incompatible	Compatible	Incompatible	Compatible
Barium Complex	Incompatible	Best Choice	Incompatible	Compatible	Incompatible	Compatible	Incompatible	Incompatible	Incompatible	Incompatible	Incompatible	Borderline
Calcium Stearate	Incompatible	Incompatible	Best Choice	Compatible	Incompatible	Compatible	Compatible	Compatible	Borderline	Compatible	Incompatible	Compatible
Calcium 12 Hydroxy	Compatible	Compatible	Compatible	Best Choice	Borderline	Borderline	Compatible	Compatible	Compatible	Compatible	Incompatible	Compatible
Calcium Complex	Incompatible	Incompatible	Incompatible	Borderline	Best Choice	Incompatible	Incompatible	Incompatible	Incompatible	Compatible	Compatible	Compatible
Calcium Sulfonate	Borderline	Compatible	Compatible	Borderline	Incompatible	Best Choice	Incompatible	Borderline	Borderline	Compatible	Incompatible	Compatible
Timken Premium Mill Timken Heavy-Duty Moly	Borderline	Compatible	Compatible	Borderline	Incompatible	Best Choice	Incompatible	Borderline	Borderline	Compatible	Incompatible	Compatible
Clay Non-Soap	Incompatible	Incompatible	Compatible	Compatible	Incompatible	Incompatible	Best Choice	Incompatible	Incompatible	Incompatible	Incompatible	Borderline
Lithium Stearate	Incompatible	Incompatible	Compatible	Compatible	Borderline	Incompatible	Incompatible	Best Choice	Compatible	Compatible	Incompatible	Compatible
Lithium 12 Hydroxy	Incompatible	Incompatible	Borderline	Compatible	Borderline	Incompatible	Incompatible	Compatible	Best Choice	Compatible	Incompatible	Compatible
Lithium Complex	Compatible	Incompatible	Compatible	Compatible	Compatible	Compatible	Incompatible	Compatible	Compatible	Best Choice	Incompatible	Compatible
Polyurea Conventional	Incompatible	Incompatible	Incompatible	Incompatible	Compatible	Incompatible	Incompatible	Incompatible	Incompatible	Incompatible	Best Choice	Compatible
Polyurea Shear Stable	Compatible	Borderline	Compatible	Compatible	Compatible	Compatible	Borderline	Compatible	Compatible	Compatible	Compatible	Best Choice
Timken Multi-Use	Incompatible	Incompatible	Borderline	Compatible	Incompatible	Borderline	Incompatible	Compatible	Best Choice	Compatible	Incompatible	Compatible
Timken All-Purpose Timken Synthetic	Compatible	Incompatible	Compatible	Compatible	Compatible	Compatible	Incompatible	Compatible	Compatible	Best Choice	Incompatible	Compatible
Timken Pillow Block	Compatible	Borderline	Compatible	Compatible	Compatible	Compatible	Borderline	Compatible	Compatible	Compatible	Compatible	Best Choice

NOTE

Mixing greases can result in improper bearing lubrication.
Always follow the specific lubrication instructions of your equipment supplier.

BEARING DATA

The following topics are covered within this section:

Nomenclature.....	66
Angular Contact Thrust Ball Bearings	69
Type TVL.....	69
Type DTVL.....	73
Thrust Cylindrical Roller Bearings	75
Type TP.....	75
Type TPS	81
Thrust Spherical Roller Bearings.....	85
Type TSR-EJ and TSR-EM.....	85
Thrust Tapered Roller Bearings.....	93
Type TTHD	93
Type TTHDFL	99
Type TTHDFLSA	105
Types TTSP, TTSPS and TTSPSPL	107
Types TTC, TTCS and TTCL	111
Screwdown Bearings – Types TTHDSX/SV and TTHDFLSX/SV	117
Types TTDWK and TTDFLK	127
Crossed Roller Bearings Type TXR.....	135

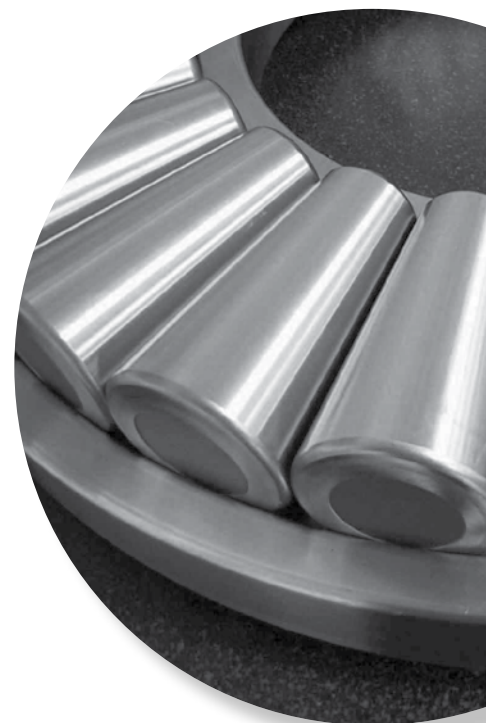

NOMENCLATURE

THRUST BALL, CYLINDRICAL AND TAPERED SCREWDOWN BEARINGS

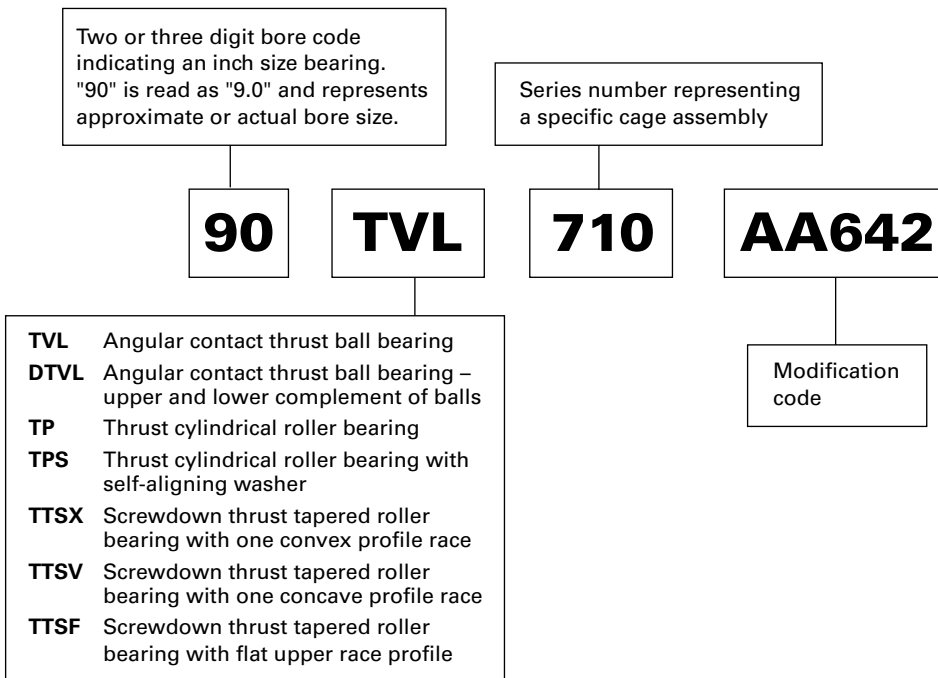

Fig. 53. Thrust ball, cylindrical and tapered screwdown bearings nomenclature.

THRUST SPHERICAL ROLLER BEARINGS

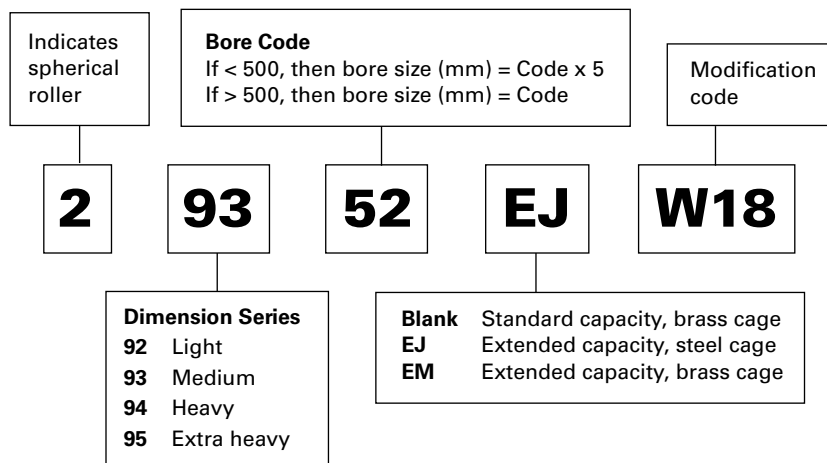

Fig. 54. Thrust spherical roller bearings nomenclature.

STANDARD THRUST TAPERED ROLLER BEARINGS

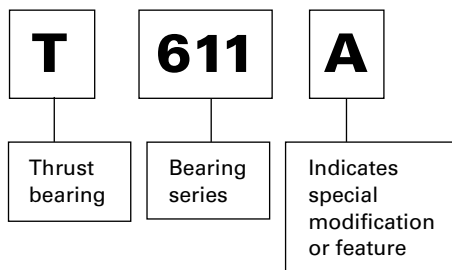

Fig. 55. Standard thrust tapered roller bearings nomenclature.

CROSSED ROLLER BEARINGS

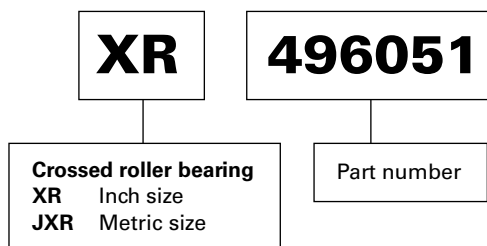

Fig. 56. Crossed roller bearings nomenclature.

SPECIAL PART NUMBERS

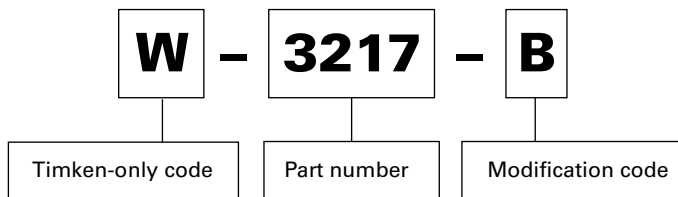

Fig. 57. Special part numbers nomenclature.

ANGULAR CONTACT THRUST BALL BEARINGS TYPE TVL

- Single-row angular contact construction.
- Provides exceptionally low friction, cool running and quiet operation when operated at high speeds.
- Accommodates axial loads as well as moderate radial loads.

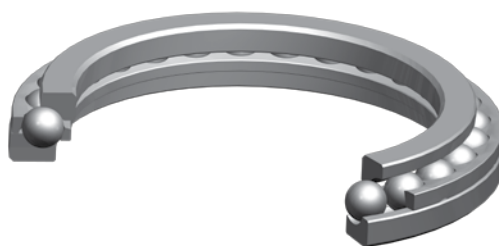
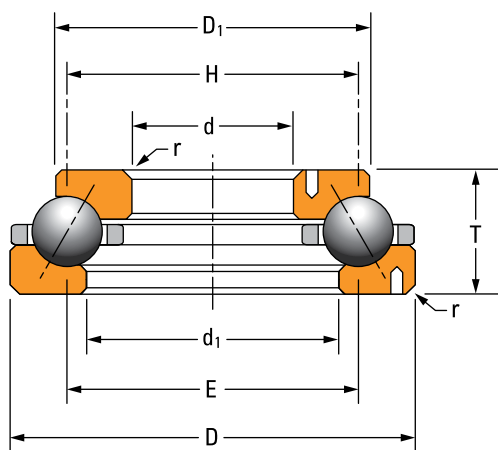

Fig. 58. Type TVL angular contact thrust ball bearing.



OVERALL DIMENSIONS:

- d – Bore diameter
- D – Bearing O.D.
- T – Bearing width
- d₁ – Large ring I.D.
- D₁ – Small ring O.D.
- E – Housing shoulder diameter
- H – Shaft shoulder diameter
- r – Shaft/housing maximum fillet radius

Fig. 59. Type TVL angular contact thrust ball bearing assembly.

THRUST BEARING DATA

ANGULAR-CONTACT THRUST BALL BEARING – TYPE TVL

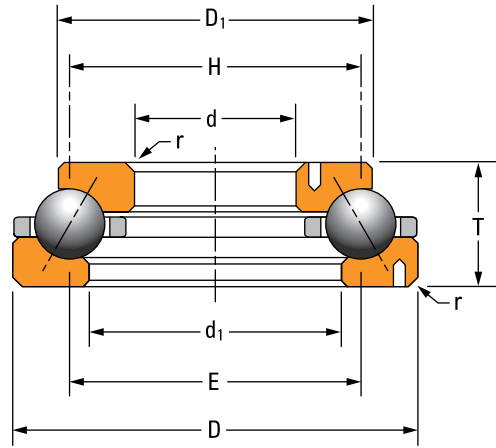
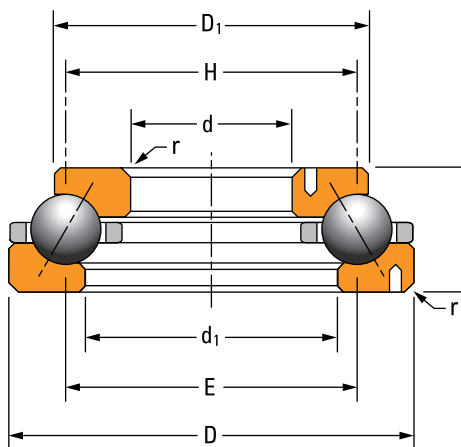

TABLE 39. ANGULAR CONTACT THRUST BALL BEARING PRODUCT DATA – TYPE TVL

Bearing Number	Bearing Dimensions			Rings		Shoulder Diameter		Dowel Pin (One Per Ring)			Fillet ⁽¹⁾ Radius (Max.)	Load Rating		Bearing Weight
	Bore	O.D.	Width	Small Diameter O.D.	Large Bore I.D.	Shaft (Min.)	Housing (Max.)	Pin Dia.	Hole Location from Centerline			Static Load Rating	Dynamic Load Rating	
	d	D	T	D ₁	d ₁	H	E		Small Bore Ring	Large Bore Ring	r	C _{a0}	C _a	
	mm in.	mm in.	mm in.	mm in.	mm in.	mm in.	mm in.	mm in.	mm in.	mm in.	mm in.	kN lbf.	kN lbf.	kg lbs.
90TVL710	228.600 9.0000	295.275 11.6250	38.100 1.5000	277.81 10.938	246.06 9.688	261.9 10.31	261.9 10.31	–	–	–	3.2 0.12	480 108260	140 32070	6.2 13.6
120TVL700	304.800 12.0000	406.400 16.0000	57.150 2.2500	368.30 14.500	342.90 13.500	355.6 14.00	355.6 14.00	9.5 0.38	165.1 6.50	190.5 7.50	3.2 0.12	1370 306810	350 78660	18.5 40.8
150TVL701	381.000 15.0000	520.700 20.5000	84.125 3.3120	482.60 19.000	419.10 16.500	450.8 17.75	450.8 17.75	12.7 0.50	206.4 8.12	244.5 9.62	4.8 0.19	2300 517800	510 114270	50.2 110.7
170TVL500	431.800 17.0000	635.000 25.0000	88.900 3.5000	565.15 22.250	488.95 19.250	533.4 21.00	533.4 21.00	12.7 0.50	235.0 9.25	298.4 11.75	7.9 0.31	3250 729730	660 149160	89.6 197.5
180TVL605	457.200 18.0000	625.475 24.6250	92.075 3.6250	549.28 21.625	508.00 20.000	541.3 21.31	541.3 21.31	15.9 0.63	247.6 9.75	285.8 11.25	3.2 0.12	3510 788300	730 163720	78.4 172.9
195TVL470	495.300 19.5000	584.200 23.0000	57.150 2.2500	571.50 22.500	508.00 20.000	539.8 21.25	539.8 21.25	9.5 0.38	258.8 10.19	281.0 11.06	3.2 0.12	1990 446550	400 89490	28.4 62.7
200TVL850	508.000 20.0000	704.850 27.7500	117.475 4.6250	628.68 24.750	565.15 22.250	606.4 23.88	606.4 23.88	15.9 0.63	276.2 10.88	330.2 13.00	6.4 0.25	3830 859870	750 167720	127.3 280.7
201TVL615	511.175 20.1250	628.650 24.7500	66.675 2.6250	590.55 23.250	549.28 21.625	569.9 22.44	569.9 22.44	12.7 0.50	268.3 10.56	300.0 11.81	3.2 0.12	2520 566060	490 110380	41.9 92.3
202TVL620	514.350 20.5000	704.850 27.7500	114.300 4.5000	622.30 24.500	571.50 22.500	609.6 24.00	609.6 24.00	20.6 0.81	279.4 11.00	327.0 12.88	6.4 0.25	4340 974600	840 189020	122.3 269.7
227TVL302	577.850 22.7500	774.700 30.5000	117.475 4.6250	704.85 27.750	622.30 24.500	676.3 26.62	676.3 26.62	20.6 0.81	311.2 12.25	365.1 14.38	6.4 0.25	4900 1102440	880 198370	149.8 330.2
233TVL303	593.725 23.3750	790.575 31.1250	117.475 4.6250	720.72 28.375	650.88 25.625	692.2 27.25	692.2 27.25	22.2 0.88	320.7 12.62	369.9 14.56	6.4 0.25	5090 1143430	900 202060	150.7 332.2
238TVL304	606.425 23.8750	847.725 35.3950	133.350 5.2500	739.78 29.125	688.98 27.125	727.1 28.62	727.1 28.62	22.2 0.88	327.0 12.88	396.9 15.62	6.4 0.25	6240 1403430	1090 243980	212.6 468.7
245TVL716	622.300 24.5000	768.350 30.2500	82.550 3.2500	733.42 28.875	680.47 26.790	695.3 27.38	695.3 27.38	12.7 0.50	323.8 12.75	371.5 14.62	3.2 0.12	2940 660340	510 114390	76.2 168.0
245TVL612	622.300 24.5000	831.850 32.7500	117.475 4.6250	742.95 29.250	679.45 26.750	727.1 28.62	727.1 28.62	15.9 0.63	330.2 13.00	396.9 15.62	6.4 0.25	5280 1187860	910 203680	164.5 362.7

⁽¹⁾Maximum shaft or housing fillet radius that bearing corners will clear.

Continued on next page.



Continued from previous page.

Bearing Number	Bearing Dimensions			Rings		Shoulder Diameter		Dowel Pin (One Per Ring)			Fillet ⁽¹⁾ Radius (Max.)	Load Rating		Bearing Weight
	Bore	O.D.	Width	Small Diameter O.D.	Large Bore I.D.	Shaft (Min.)	Housing (Max.)	Pin Dia.	Hole Location from Centerline			Static Load Rating	Dynamic Load Rating	
	d	D	T	D ₁	d ₁	H	E		Small Bore Ring	Large Bore Ring	r	C _{a0}	C _a	
	mm in.	mm in.	mm in.	mm in.	mm in.	mm in.	mm in.	mm in.	mm in.	mm in.	mm in.	kN lbf.	kN lbf.	kg lbs.
252TVL505	341.350 25.2500	793.750 31.2500	88.900 3.5000	746.12 29.375	708.02 27.875	717.6 28.25	717.6 28.25	12.7 0.50	342.9 13.50	376.2 14.81	6.4 0.25	4120 925070	710 159440	89.3 197.0
260TVL635	660.400 26.0000	893.350 35.2500	133.350 5.2500	790.58 31.125	727.08 28.625	777.9 30.62	777.9 30.62	20.6 0.81	355.6 14.00	422.3 16.62	6.4 0.25	7030 1580800	1150 259090	226.9 500.4
302TVL510	768.350 30.2500	920.750 36.2500	88.900 3.5000	873.12 34.375	835.02 32.875	844.6 33.25	844.6 33.25	12.7 0.50	408.0 16.06	439.7 17.31	6.4 0.25	4850 1089700	750 168910	105.2 231.9
302TVL624	768.350 30.2500	1006.475 39.6250	139.700 5.5000	901.70 35.500	838.20 33.000	887.4 34.94	887.4 34.94	22.2 0.88	409.6 16.12	476.2 18.75	6.4 0.25	7870 1770010	1190 267400	271.1 597.8
303TVL706	771.525 30.3750	898.525 35.3750	63.500 2.5000	860.42 33.875	809.62 31.875	835.0 32.88	835.0 32.88	12.7 0.50	403.2 15.88	431.8 17.00	6.4 0.25	3040 682650	460 102250	58.0 128.0
309TVL707	785.812 30.9375	952.500 37.5000	95.250 3.7500	882.65 34.750	857.25 33.750	870.0 34.25	870.0 34.25	15.9 0.63	415.9 16.38	454.0 17.88	6.4 0.25	3240 727460	570 127850	117.9 260.0
310TVL625	787.400 31.0000	1025.525 40.3750	139.700 5.5000	917.58 36.125	893.76 35.188	906.5 35.69	906.5 35.69	22.2 0.88	422.3 16.62	485.8 19.12	6.4 0.25	8140 1829670	1210 271790	263.5 581.0
317TVL307	806.450 31.7500	1025.525 40.3750	127.000 5.0000	933.45 36.750	873.12 34.375	914.4 36.00	914.4 36.00	22.2 0.88	427.0 16.81	476.2 18.75	6.4 0.25	8140 1829670	1210 271790	240.6 530.6
402TVL717	1022.350 40.2500	1181.100 46.5000	88.900 3.5000	1133.48 44.625	1069.98 42.125	1101.7 43.38	1101.7 43.38	19.1 0.75	530.2 20.88	571.5 22.50	6.4 0.25	6310 1418330	820 185160	147.8 326.0
410TVL718	1041.400 41.0000	1260.475 49.6250	127.000 5.0000	1189.04 46.812	1112.84 43.812	1150.9 45.31	1150.9 45.31	19.1 0.75	544.5 21.44	606.4 23.88	6.4 0.25	10590 2380340	1340 301160	308.8 681.0
420TVL721	1066.800 42.0000	1285.875 50.6250	127.000 5.0000	1214.44 47.812	1138.24 44.812	1176.3 46.31	1176.3 46.31	22.2 0.88	560.4 22.06	616.0 24.25	6.4 0.25	10600 2383620	1330 299290	315.2 695.0
530TVL719	1346.200 53.0000	1517.650 59.7500	104.775 4.1250	1457.32 57.375	1406.52 55.375	1431.9 56.38	1431.9 56.38	22.2 0.88	695.3 27.38	733.4 28.88	6.4 0.25	7080 1590850	810 183060	230.0 506.0
540TVL720	1371.600 54.0000	1619.250 63.7500	139.700 5.5000	1533.52 60.375	1457.32 57.375	1495.4 58.88	1495.4 58.88	22.2 0.88	714.4 28.12	781.0 30.75	6.4 0.25	13880 3119420	1470 331050	480.3 1059.0

⁽¹⁾Maximum shaft or housing fillet radius that bearing corners will clear.

TYPE DTVL

- Double-row angular contact construction.
- Designed to accommodate high axial loads in one direction, a lighter axial load in the opposite direction, as well as moderate radial loads.
- Compact design which is ideal for applications where not enough space is available for two TVL bearings.

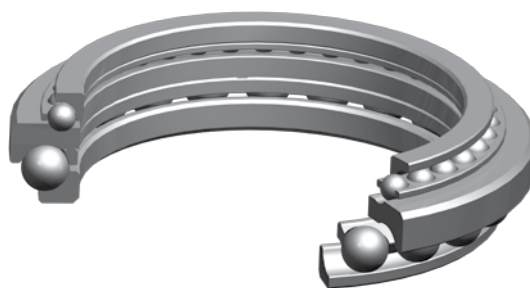
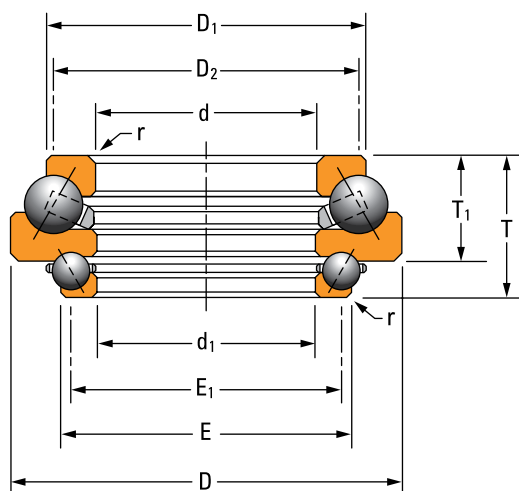

Fig. 60. Type DTVL angular contact thrust ball bearing.



OVERALL DIMENSIONS:

- d – Upper bore diameter
- d₁ – Lower bore diameter
- D – Bearing O.D.
- T – Overall bearing width
- D₁ – Upper race O.D.
- E – Lower race O.D.
- D₂ – Upper race shaft shoulder diameter
- E₁ – Lower race shaft shoulder diameter
- T₁ – Upper bearing width
- r – Shaft/housing maximum fillet radius

Fig. 61. Type DTVL angular contact thrust ball bearing assembly.

THRUST BEARING DATA

ANGULAR CONTACT THRUST BALL BEARING – TYPE DTVL

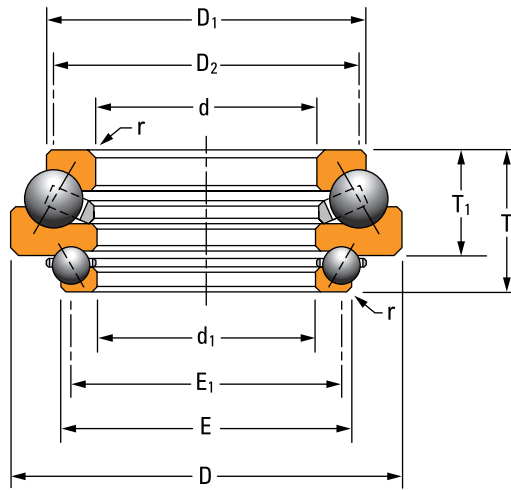

TABLE 40. ANGULAR CONTACT THRUST BALL BEARING PRODUCT DATA – TYPE DTVL

Bearing Number	Bearing Dimensions				Upper Race		Lower Race		Fillet ⁽¹⁾ Radius (Max.)	r	Load Rating			Bearing Weight
	Upper Bore	Lower Bore	O.D.	Width	O.D.	Shoulder	O.D.	Shoulder			Upper Static Load Rating	Upper Dynamic Load Rating	Lower Static Load Rating	
	d	d ₁	D	T	D ₁	D ₂	E	E ₁			C _{a0}	C _a	C _{a0}	
	mm in.	mm in.	mm in.	mm in.	mm in.	mm in.	mm in.	mm in.	mm in.	kN lbf.	kN lbf.	kN lbf.	kg lbs.	
200DTV1722	508.000 20.0000	508.000 20.0000	742.950 29.2500	171.450 6.7500	679.45 26.750	616.00 24.250	587.38 23.125	558.80 22.000	127.00 5.000	6.4 0.25	4000 898500	790 177530	2730 613750	177.3 391.0
202DTV1723	514.350 20.2500	511.175 20.1250	704.850 27.7500	158.750 6.2500	622.30 24.500	609.60 24.000	590.55 23.250	569.90 22.440	114.30 4.500	6.4 0.25	3990 896630	800 178800	2890 648750	133.3 294.0
235DTV1724	596.900 23.5000	590.550 23.2500	838.200 33.0000	184.150 7.2500	774.70 30.500	711.20 28.000	676.28 26.625	647.70 25.500	139.70 5.500	6.4 0.25	5280 1186240	940 212230	3460 777590	246.2 543.0
245DTV1725	622.300 24.5000	619.125 24.3750	815.975 32.1250	158.750 6.2500	730.25 28.750	717.60 28.250	698.50 27.500	677.90 26.680	114.30 4.500	6.4 0.25	4750 1067510	850 190500	3220 722910	157.4 347.0
266DTV1726	676.275 26.6250	673.100 26.5000	914.400 36.0000	193.675 7.6250	876.30 34.500	787.40 31.000	787.40 31.000	743.00 29.250	142.88 5.625	6.4 0.25	5960 1340100	990 222700	3930 883820	296.6 654.0
305DTV1727	774.700 30.5000	768.350 30.2500	971.550 38.2500	158.750 6.2500	885.82 34.875	873.10 34.380	847.72 33.380	827.10 32.560	114.30 4.500	6.4 0.25	5240 1176690	820 183480	3790 851800	194.6 429.0
312DTV1728	793.750 31.2500	787.400 31.0000	1006.475 39.6250	200.025 7.8750	1000.12 39.375	895.40 35.250	901.70 35.500	863.60 34.000	139.70 5.500	6.4 0.25	6880 1545670	1050 235560	5470 1229100	325.2 717.0
N-3214-A	822.400 32.3780	808.150 31.8170	1066.670 41.9950	192.710 7.5870	944.58 37.188	927.10 36.500	908.05 35.750	885.82 34.875	152.40 6.000	7.5 0.30	9370 2106090	1300 292780	2980 668740	462.0 1020.0
405DTV1729	1028.700 40.5000	1025.525 40.3750	1231.900 48.5000	158.750 6.2500	1143.00 45.000	1130.30 44.500	1104.90 43.500	1084.30 42.690	114.30 4.500	6.4 0.25	7070 1589580	920 206180	4520 1014510	254.4 561.0
412DTV1730	1047.750 41.2500	1041.400 41.0000	1260.475 49.6250	200.025 7.8750	1254.12 49.375	1149.40 45.250	1155.70 45.500	1117.60 44.000	139.70 5.500	6.4 0.25	9380 2108710	1440 322900	6340 1424580	417.2 920.0
N-3492-A	1049.465 41.3175	1050.210 41.3470	1269.873 49.9950	202.296 7.9644	1173.17 46.188	1147.60 45.180	1155.70 45.500	1128.50 44.430	154.00 6.063	6.4 0.25	9990 2245560	1220 275050	3870 870440	475.0 1048.0
541DTV1731	1374.775 54.1250	1371.600 54.0000	1597.025 62.8750	247.650 9.7500	1536.70 60.500	1481.10 58.310	1489.08 58.625	1447.80 57.000	168.28 6.625	6.4 0.25	13610 3060560	1390 311470	8730 1962070	654.4 1443.0
N-3217-A	1397.330 55.0130	1400.560 55.1400	1650.870 64.9950	233.375 9.1880	1552.58 61.125	1524.00 60.000	1524.00 60.000	1485.90 58.500	182.56 7.188	6.4 0.25	14960 3363110	1510 340220	4570 1026540	631.0 1392.0
C-8598-A	1654.180 65.1250	1651.000 65.0000	1905.000 75.0000	254.000 10.0000	1854.20 73.000	1816.10 71.500	1790.70 70.500	1765.30 69.500	184.15 7.250	6.4 0.25	16820 3781880	1570 353790	7550 1698000	917.0 2023.0
N-3488-A	1689.430 66.5130	1692.660 66.6400	1943.100 76.5000	254.000 10.0000	1879.60 74.000	1803.40 71.000	1828.80 72.000	1778.00 70.000	209.55 8.250	7.5 0.30	16850 3786940	1550 349420	7560 1700530	1270.0 2800.0

⁽¹⁾Maximum shaft or housing fillet radius that bearing corners will clear.

THRUST CYLINDRICAL ROLLER BEARINGS

TYPE TP

- Two or three cylindrical rollers per cage pocket to enhance true rolling motion and prevent roller skewing.
- Simple and economical design with easy installation.
- Minor radial displacement of the races does not affect operation, resulting in manufacturing economy and simplified installation.

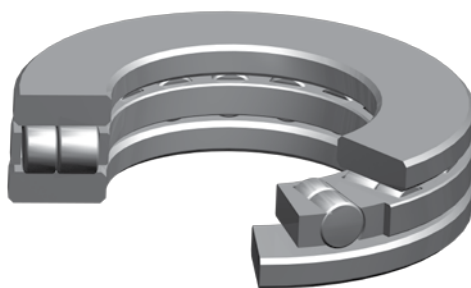
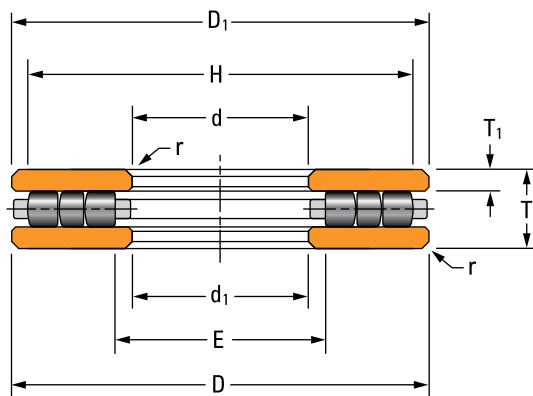

Fig. 62. Type TP thrust cylindrical roller bearing.



OVERALL DIMENSIONS:

- d – Bore diameter
- D – Bearing O.D.
- T – Bearing width
- T₁ – Ring thickness
- d₁ – Large bore I.D.
- D₁ – Small diameter O.D.
- E – Housing shoulder diameter
- H – Shaft shoulder diameter
- r – Shaft/housing maximum fillet radius

Fig. 63. Type TP thrust cylindrical roller bearing assembly.

THRUST BEARING DATA

THRUST CYLINDRICAL ROLLER BEARING – TYPE TP

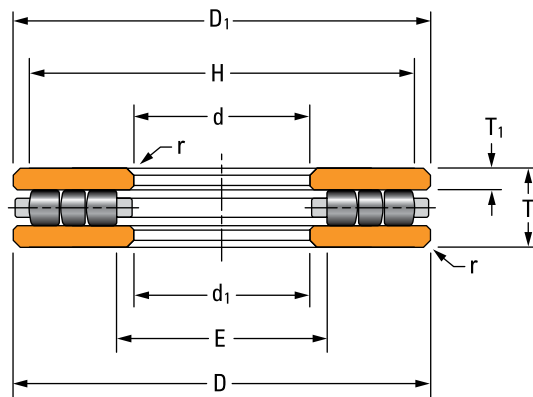
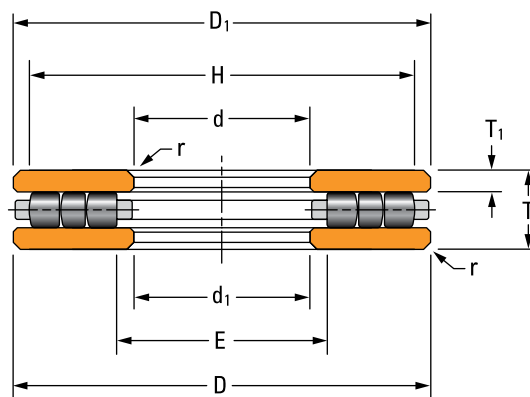

TABLE 41. THRUST CYLINDRICAL ROLLER BEARING – TYPE TP

Bearing Number	Bearing Dimensions			Rings			Shoulder Diameter		Fillet ⁽¹⁾ Radius (Max.)	Load Rating		Limiting Speed	Bearing Weight
	Bore	O.D.	Width	Thickness	Small Diameter O.D.	Large Bore I.D.	Shaft (Min.)	Housing (Max.)		Static Load Rating	Dynamic Load Rating		
	d	D	T	T ₁	D ₁	d ₁	H	E	C _{a0}	C _a	RPM	kg lbs.	
20TP103	50.800 2.0000	152.400 6.0000	34.925 1.3750	9.52 0.375	150.81 5.938	52.39 2.062	141.3 5.56	61.9 2.44	1.6 0.06	1400 315400	400 84300	1900	3.7 8.1
20TP104	50.800 2.0000	177.800 7.0000	34.925 1.3750	9.52 0.375	176.21 6.938	52.39 2.062	163.5 6.44	65.1 2.56	1.6 0.06	1700 384200	400 95700	1630	5.1 11.3
30TP106	76.200 3.0000	152.400 6.0000	34.925 1.3750	9.52 0.375	150.81 5.938	77.79 3.062	142.9 5.62	85.7 3.38	1.6 0.06	1200 279500	300 74200	1900	3.2 7.0
30TP107	76.200 3.0000	177.800 7.0000	34.925 1.3750	9.52 0.375	176.21 6.938	77.79 3.062	166.7 6.56	87.3 3.44	1.6 0.06	1800 401500	400 96100	1630	4.6 10.2
30TP108	76.200 3.0000	203.200 8.0000	34.925 1.3750	9.52 0.375	201.61 7.938	77.79 3.062	188.9 7.44	90.5 3.56	1.6 0.06	2300 523800	500 115500	1420	6.3 13.9
30TP109	76.200 3.0000	228.600 9.0000	34.925 1.3750	9.52 0.375	227.01 8.938	77.79 3.062	212.7 8.38	92.1 3.62	1.6 0.06	3100 698300	600 141400	1260	8.2 18.1
35TP113	88.900 3.5000	132.558 5.2188	25.400 1.0000	7.14 0.281	130.97 5.156	90.49 3.562	123.8 4.88	97.6 3.84	1.6 0.06	700 146200	200 37000	2190	1.4 3.0
40TP114	101.600 4.0000	177.800 7.0000	44.450 1.7500	12.70 0.500	176.21 6.938	103.19 4.062	168.3 6.62	111.1 4.38	1.6 0.06	1700 372500	400 97200	1630	5.0 11.0
40TP115	101.600 4.0000	203.200 8.0000	44.450 1.7500	12.70 0.500	201.61 7.938	103.19 4.062	190.5 7.50	114.3 4.50	1.6 0.06	2300 515700	500 122800	1420	7.1 15.6
40TP116	101.600 4.0000	228.600 9.0000	44.450 1.7500	12.70 0.500	227.01 8.938	103.19 4.062	214.3 8.44	115.9 4.56	1.6 0.06	3000 683500	700 150200	1260	9.5 21.0
40TP117	101.600 4.0000	254.000 10.0000	44.450 1.7500	12.70 0.500	252.41 9.938	103.19 4.062	238.1 9.38	117.5 4.62	1.6 0.06	3700 827600	800 171400	1140	11.6 25.6
50TP119	127.000 5.0000	203.200 8.0000	44.450 1.7500	12.70 0.500	201.61 7.938	128.59 5.062	190.5 7.50	139.7 5.50	1.6 0.06	2100 465800	500 110700	1420	5.9 13.1
50TP120	127.000 5.0000	228.600 9.0000	44.450 1.7500	12.70 0.500	227.01 8.938	128.59 5.062	215.9 8.50	139.7 5.50	1.6 0.06	2900 645200	600 140400	1260	8.3 18.4
50TP121	127.000 5.0000	254.000 10.0000	50.800 2.0000	14.29 0.562	252.41 9.938	128.59 5.062	239.7 9.44	141.3 5.56	3.2 0.12	3700 835900	800 184000	1140	12.4 27.4
50TP122	127.000 5.0000	279.400 11.0000	50.800 2.0000	14.29 0.562	277.81 10.938	128.59 5.062	261.9 10.31	144.5 5.69	3.2 0.12	4800 1073500	1000 220000	1030	15.8 34.8
50TP123	127.000 5.0000	304.800 12.0000	50.800 2.0000	14.29 0.562	303.21 11.938	128.59 5.062	288.9 11.38	146.0 5.75	3.2 0.12	5600 1248900	1100 244200	950	19.4 42.8

⁽¹⁾Maximum shaft or housing fillet radius that bearing corners will clear.

Continued on next page.



Continued from previous page.

Bearing Number	Bearing Dimensions			Rings			Shoulder Diameter		Fillet ⁽¹⁾ Radius (Max.)	Load Rating		Limiting Speed	Bearing Weight
	Bore	O.D.	Width	Thickness	Small Diameter O.D.	Large Bore I.D.	Shaft (Min.)	Housing (Max.)		Static Load Rating	Dynamic Load Rating		
	d	D	T	T ₁	D ₁	d ₁	H	E		C ₁₀	C ₉₀		
	mm in.	mm in.	mm in.	mm in.	mm in.	mm in.	mm in.	mm in.	mm in.	kN lbf.	kN lbf.	RPM	kg lbs.
60TP124	152.400 6.0000	228.600 9.0000	50.800 2.0000	14.29 0.562	227.01 8.938	153.99 6.062	217.2 8.56	163.5 6.44	3.2 0.12	2400 543800	600 131100	1260	7.6 16.8
60TP125	152.400 6.0000	254.000 10.0000	50.800 2.0000	14.29 0.562	252.41 9.938	153.99 6.062	241.3 9.50	165.1 6.50	3.2 0.12	3300 738800	700 164000	1140	10.7 23.7
60TP126	152.400 6.0000	279.400 11.0000	50.800 2.0000	14.29 0.562	277.81 10.938	153.99 6.062	265.1 10.44	166.7 6.56	3.2 0.12	4600 1032600	900 209600	1030	14.2 31.4
60TP127	152.400 6.0000	304.800 12.0000	50.800 2.0000	14.29 0.562	303.31 11.938	153.99 6.062	287.3 11.31	169.9 6.69	3.2 0.12	5600 1252500	1100 240600	950	17.7 39.4
S-4789-A ⁽²⁾	174.625 6.8750	279.400 11.0000	69.850 2.7500	19.05 0.750	279.40 11.000	174.63 6.875	262.6 10.34	186.4 7.34	1.8 0.07	3051 686000	1156 260000	1030	17.4 38.3
70TP129	177.800 7.0000	254.000 10.0000	50.800 2.0000	14.29 0.562	251.62 9.906	180.18 7.094	242.9 9.56	188.9 7.44	3.2 0.12	2800 625400	600 141600	1140	9.2 20.2
70TP130	177.800 7.0000	279.400 11.0000	50.800 2.0000	14.29 0.562	277.02 10.906	180.18 7.094	266.7 10.50	190.5 7.50	3.2 0.12	3900 886500	800 183200	1030	12.8 28.3
70TP131	177.800 7.0000	304.800 12.0000	50.800 2.0000	14.29 0.562	302.42 11.906	180.18 7.094	288.9 11.38	193.7 7.62	3.2 0.12	5200 1180100	1000 226200	950	16.8 37.0
70TP132	177.800 7.0000	355.600 14.0000	76.200 3.0000	20.64 0.812	353.22 13.906	180.18 7.094	335.0 13.19	198.4 7.81	6.4 0.25	7500 1692700	1700 374300	810	36.3 80.1
80TP134	203.200 8.0000	304.800 12.0000	76.200 3.0000	20.64 0.812	302.42 11.906	205.58 8.094	292.1 11.50	215.9 8.50	6.4 0.25	4500 1016000	1100 254000	950	20.5 45.1
80TP135	203.200 8.0000	355.600 14.0000	76.200 3.0000	20.64 0.812	353.22 13.906	205.58 8.094	336.6 13.25	222.2 8.75	6.4 0.25	6900 1558900	1500 346200	810	33.0 72.8
80TP136	203.200 8.0000	406.400 16.0000	76.200 3.0000	20.64 0.812	404.02 15.906	205.58 8.094	382.6 15.06	227.0 8.94	6.4 0.25	9300 2091300	1900 426700	710	44.5 98.1
90TP139	228.600 9.0000	355.600 14.0000	76.200 3.0000	20.64 0.812	353.22 13.906	230.98 9.094	339.7 13.38	244.5 9.62	6.4 0.25	6800 1524300	1500 335900	810	29.3 64.5
90TP140	228.600 9.0000	406.400 16.0000	76.200 3.0000	20.64 0.812	404.02 15.906	230.98 9.094	385.8 15.19	249.2 9.81	6.4 0.25	9400 2115800	1900 425600	710	43.6 96.2
C-8360-A	238.125 9.3750	307.975 12.1250	38.100 1.5000	11.11 0.438	306.39 12.063	238.51 9.390	296.9 11.69	249.2 9.81	3.18 0.125	2380 535500	440 99000	940	6.7 14.8
100TP143	254.000 10.0000	406.400 16.0000	76.200 3.0000	20.64 0.812	404.02 15.906	256.38 10.094	387.4 15.25	273.0 10.75	6.4 0.25	8500 1905400	1700 387800	710	39.5 86.6

⁽¹⁾Maximum shaft or housing fillet radius that bearing corners will clear.

⁽²⁾Bearing includes special features; contact your Timken engineer for details.

Continued on next page.

THRUST BEARING DATA

THRUST CYLINDRICAL ROLLER BEARING – TYPE TP

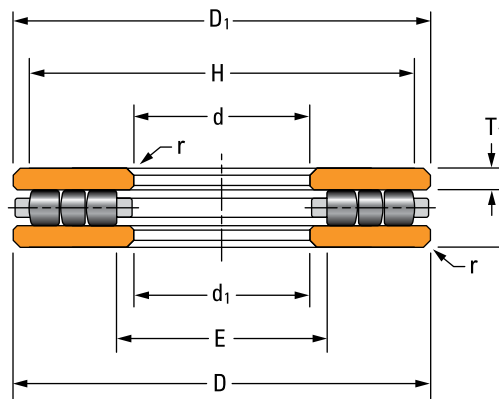

TABLE 41. THRUST CYLINDRICAL ROLLER BEARING – TYPE TP – continued

Bearing Number	Bearing Dimensions			Rings			Shoulder Diameter		Fillet ⁽¹⁾ Radius (Max.) r	Load Rating		Limiting Speed RPM	Bearing Weight kg lbs.
	Bore	O.D.	Width	Thickness	Small Diameter O.D.	Large Bore I.D.	Shaft (Min.)	Housing (Max.)		Static Load Rating	Dynamic Load Rating		
	d	D	T	T ₁	D ₁	d ₁	H	E		C ₁₀	C ₉₀		
	mm in.	mm in.	mm in.	mm in.	mm in.	mm in.	mm in.	mm in.	mm in.	kN lbf.	kN lbf.		kg lbs.
100TP144	254.000 10.0000	457.200 18.0000	95.250 3.7000	26.19 1.031	454.82 17.906	256.38 10.094	435.0 17.12	276.2 10.88	6.4 0.25	12000 2702600	2500 559800	630	68.8 151.8
100TP145	254.000 10.0000	508.000 20.0000	95.250 3.7500	26.19 1.031	505.62 19.906	256.38 10.094	481.0 18.94	281.0 11.06	6.4 0.25	15600 3512400	3000 674900	570	91.7 202.2
F-2658-B	280.000 11.0236	375.400 14.7795	53.010 2.0870	15.39 0.606	374.60 14.748	283.01 11.142	362.0 14.25	292.1 11.50	1.5 0.06	5410 1217180	953 214320	770	17.4 38.2
120TP151	304.800 12.0000	457.200 18.0000	95.250 3.7500	26.19 1.031	454.82 17.906	307.18 12.094	438.2 17.25	323.8 12.75	6.4 0.25	10800 2423100	2200 503600	630	56.7 125.1
120TP152	304.800 12.0000	508.000 20.0000	114.300 4.5000	31.75 1.250	505.62 19.906	307.18 12.094	484.2 19.06	328.6 12.94	6.4 0.25	12800 2888000	2800 626100	570	104.5 230.5
120TP153	304.800 12.0000	609.600 24.0000	114.300 4.5000	31.75 1.250	607.22 23.906	307.18 12.094	584.2 23.00	330.2 13.00	6.4 0.25	21200 4772700	4000 901500	470	168.5 371.5
S-4790-A ⁽²⁾	330.200 13.0000	495.300 19.5000	88.900 3.5000	24.51 0.965	495.30 19.500	330.20 13.000	472.2 18.59	352.5 13.88	5.6 0.22	9329 2098000	2575 579000	580	63.5 139.6
140TP158	355.600 14.0000	508.000 20.0000	95.250 3.7500	26.19 1.031	504.82 19.875	358.78 14.125	489.0 19.25	374.6 14.75	6.4 0.25	12500 2801900	2400 546300	570	62.6 138.1
140TP159	355.600 14.0000	558.800 22.0000	95.250 3.7500	26.19 1.031	555.62 21.875	358.78 14.125	535.0 21.06	379.4 14.94	6.4 0.25	16700 3753400	3000 677200	520	89.6 197.5
140TP160	355.600 14.0000	609.600 24.0000	95.250 3.7500	26.19 1.031	606.40 23.875	358.78 14.125	581.0 22.88	384.2 15.12	6.4 0.25	21600 4846200	3600 816500	470	125.3 276.2
160TP164	406.400 16.0000	558.800 22.0000	114.300 4.5000	31.75 1.250	555.60 21.875	409.60 16.125	539.8 21.25	425.4 16.75	6.4 0.25	13400 3009000	2700 616900	520	85.9 189.4
160TP165	406.400 16.0000	609.600 24.0000	114.300 4.5000	31.75 1.250	606.40 23.875	409.60 16.125	585.8 23.06	430.2 16.94	6.4 0.25	18100 4077300	3400 771600	470	121.4 267.7
160TP166	406.400 16.0000	660.400 26.0000	114.300 4.5000	31.75 1.250	657.20 25.875	409.60 16.125	633.4 24.94	433.4 17.06	6.4 0.25	23100 5191800	4100 922000	440	168.8 372.1
S-4750-A ⁽²⁾	431.800 17.0000	571.500 22.5000	88.900 3.5000	24.51 0.965	571.50 22.500	431.80 17.000	553.2 21.78	450.1 17.72	5.6 0.22	11861 2667000	2509 564000	500	70.0 154.0
E-2192-A ⁽²⁾	431.800 17.0000	609.600 24.0000	101.600 4.0000	25.40 1.000	609.47 23.995	432.44 17.025	481.0 18.94	559.6 22.03	7.6 0.30	14992 3371000	3363 756000	470	95.0 209.3
E-2191-A	457.200 18.0000	660.400 26.0000	101.600 4.0000	25.40 1.000	660.27 25.995	457.33 18.005	622.3 24.50	495.3 19.00	4.0 0.16	16241 3651000	3580 805000	430	129.8 285.6

⁽¹⁾Maximum shaft or housing fillet radius that bearing corners will clear.

⁽²⁾Bearing includes special features; contact your Timken engineer for details.

Continued on next page.

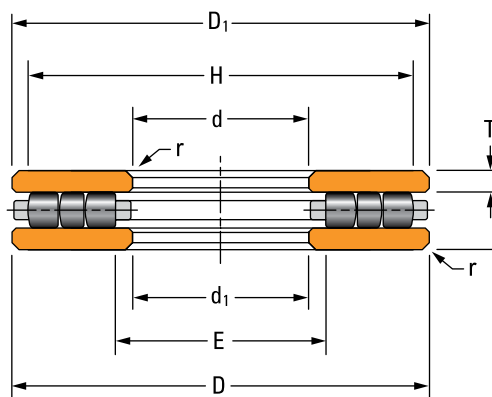

Continued from previous page.

Bearing Number	Bearing Dimensions			Rings			Shoulder Diameter		Fillet ⁽¹⁾ Radius (Max.)	Load Rating		Limiting Speed	Bearing Weight
	Bore	O.D.	Width	Thickness	Small Diameter O.D.	Large Bore I.D.	Shaft (Min.)	Housing (Max.)		Static Load Rating	Dynamic Load Rating		
	d	D	T	T ₁	D ₁	d ₁	H	E	C _{a0}	C _a	RPM	kg lbs.	
180TP168	457.200 18.0000	660.400 26.0000	127.000 5.0000	34.92 1.375	657.20 25.875	460.40 18.125	635.0 25.00	482.6 19.00	6.4 0.25	20400 4580700	3900 879900	440	148.8 328.1
180TP169	457.200 18.0000	711.200 28.0000	127.000 5.0000	34.92 1.375	708.00 27.875	460.40 18.125	684.2 26.94	484.2 19.06	6.4 0.25	25600 5754900	4600 1040500	410	195.3 430.7
180TP170	457.200 18.0000	762.000 30.0000	139.700 5.5000	38.10 1.500	758.80 29.875	460.40 18.125	735.0 28.94	484.2 19.06	6.4 0.25	33100 7434800	5900 1332100	380	280.7 618.9
S-4791-A ⁽²⁾	482.600 19.0000	673.100 26.5000	114.300 4.5000	31.75 1.250	673.10 19.000	482.60 19.000	649.7 25.58	506.0 19.92	5.6 0.22	18567 4174000	3741 841000	430	131.8 290.0
200TP171	508.000 20.0000	711.200 28.0000	139.700 5.5000	38.10 1.500	708.00 27.875	511.20 20.125	658.8 27.00	533.4 21.00	6.4 0.25	22400 5045900	4400 982700	410	178.0 392.5
200TP172	508.000 20.0000	762.000 30.0000	139.700 5.5000	38.10 1.500	758.80 29.875	511.20 20.125	736.6 29.00	533.4 21.00	6.4 0.25	28600 6421800	5200 1174900	380	232.2 512.0
200TP173	508.000 20.0000	812.800 32.0000	152.400 6.0000	42.07 1.656	809.60 31.875	511.20 20.125	787.4 31.00	533.4 21.00	6.4 0.25	37500 8422200	6600 1494800	350	317.0 698.9
B-3653-B	527.101 20.7520	635.127 25.0050	44.450 1.7500	11.13 0.438	635.13 25.005	527.10 20.752	607.2 23.91	548.5 21.59	3.0 0.12	6660 1496180	970 218120	450	29.7 65.4
B-9054-C ⁽²⁾	572.000 22.5197	763.000 30.0394	115.000 4.5276	31.50 1.240	763.00 30.039	572.00 22.520	761.2 29.97	587.9 23.15	4.0 0.16	20583 4627000	3600 809300	380	154.5 340.0
220TP174	558.800 22.0000	762.000 30.0000	139.700 5.5000	38.10 1.500	758.80 29.875	562.00 22.125	736.6 29.00	584.2 23.00	6.4 0.25	24400 5484500	4600 1027900	380	192.7 425.0
220TP175	558.800 22.0000	812.800 32.0000	139.700 5.5000	38.10 1.500	809.60 31.875	562.00 22.125	782.6 30.81	589.0 23.19	6.4 0.25	31000 6980200	5500 1229800	350	250.6 552.6
220TP176	558.800 22.0000	863.600 34.0000	152.400 6.0000	42.07 1.656	860.40 33.875	562.00 22.125	838.2 33.00	584.2 23.00	6.4 0.25	40900 9187700	7000 1569700	330	340.9 751.6
J-903-A	609.702 24.0040	812.800 32.0000	101.727 4.0050	27.79 1.094	812.80 32.000	609.60 24.000	787.4 31.00	635.0 25.00	1.8 0.07	23740 5336110	3690 829810	350	147.0 323.0
240TP177	609.600 24.0000	812.800 32.0000	139.700 5.5000	38.10 1.500	809.60 21.875	612.80 24.125	790.6 31.12	631.8 24.88	9.5 0.38	25500 5733800	4660 1047000	350	206.5 455.4
240TP178	609.600 24.0000	863.600 34.0000	139.700 5.5000	38.10 1.500	860.40 33.875	612.80 24.125	838.2 33.00	635.0 25.00	9.5 0.38	33500 7538700	5700 1282100	330	269.0 593.2
240TP179	609.600 24.0000	914.400 36.0000	152.400 6.0000	42.07 1.656	911.20 35.875	612.80 24.125	889.0 35.00	635.0 25.00	9.5 0.38	41800 9394300	7000 1569700	310	364.7 804.2

⁽¹⁾Maximum shaft or housing fillet radius that bearing corners will clear.

⁽²⁾Bearing includes special features; contact your Timken engineer for details.

Continued on next page.

THRUST BEARING DATA

THRUST CYLINDRICAL ROLLER BEARING – TYPE TP

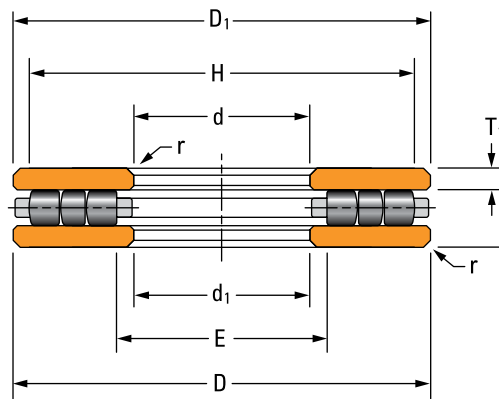

TABLE 41. THRUST CYLINDRICAL ROLLER BEARING – TYPE TP – continued

Bearing Number	Bearing Dimensions			Rings			Shoulder Diameter		Fillet ⁽¹⁾ Radius (Max.) r	Load Rating		Limiting Speed RPM	Bearing Weight kg lbs.
	Bore	O.D.	Width	Thickness	Small Diameter O.D.	Large Bore I.D.	Shaft (Min.)	Housing (Max.)		Static Load Rating	Dynamic Load Rating		
	d	D	T	T ₁	D ₁	d ₁	H	E		C _{a0}	C _a		
	mm in.	mm in.	mm in.	mm in.	mm in.	mm in.	mm in.	mm in.	mm in.	kN lbf.	kN lbf.		kg lbs.
E-2306-A	610.019 24.0165	812.546 31.9900	101.727 4.0050	27.79 1.094	812.80 32.000	610.11 24.020	787.4 31.00	635.0 25.00	1.8 0.07	23740 5336110	3690 829810	350	147.0 323.0
S-4792-A ⁽²⁾	622.300 24.5000	812.800 32.0000	114.300 4.5000	28.58 1.125	812.80 32.000	622.30 24.500	774.7 30.50	679.5 26.75	5.6 0.22	25853 5812000	5111 1149000	350	360.1 163.3
S-4745-A ⁽²⁾	695.579 27.3850	964.514 37.9730	127.127 5.0050	31.75 1.250	964.51 37.973	695.58 27.385	934.2 36.78	742.2 29.22	7.6 0.30	37646 8464000	6645 1494000	300	303.0 667.0
E-2408-A	711.200 28.0000	914.400 36.0000	114.300 4.5000	29.36 1.156	914.40 36.000	711.84 28.025	888.7 34.99	737.6 29.04	2.0 0.08	26310 5914300	4280 963100	310	180.0 397.0
E-2359-A	812.800 32.0000	1016.000 40.0000	127.000 5.0000	31.75 1.250	1015.75 39.990	813.44 32.025	990.6 39.00	838.2 33.00	4.3 0.17	30507 6859000	6672 1500000	280	264.0 581.0
E-2259-A	812.800 32.0000	1016.000 40.0000	127.000 5.0000	32.54 1.281	1016.00 40.000	813.69 32.035	990.6 39.00	838.2 33.00	1.8 0.07	32160 7230700	5150 1157600	280	243.0 535.0
E-2268-A	876.300 34.5000	1117.600 44.0000	139.700 5.5000	36.55 1.439	1117.60 44.000	876.30 34.500	1091.4 42.97	902.8 35.55	2.5 0.10	35280 7932100	5640 1266900	260	370.0 816.0
E-2311-A	940.308 37.0200	1219.708 48.0200	124.587 4.9050	40.87 1.609	1219.20 48.000	939.70 36.996	1184.3 46.63	974.7 38.38	1.8 0.07	36120 8120950	5710 1283050	240	468.0 1030.0
P-2109-A	978.540 38.5250	1370.330 53.9500	191.000 7.5200	57.40 2.260	1370.33 53.950	978.54 38.525	1335.1 52.56	1041.4 39.94	4.6 0.18	90710 20392760	12160 2734300	210	1001.9 2208.8
E-2018-C ⁽²⁾	1016.076 40.0030	1344.625 52.9380	152.400 6.0000	41.28 1.625	1320.80 52.000	40.13 1019.180	1308.1 51.50	1047.8 41.25	1.5 0.06	65994 14837000	14997 3370000	220	550.0 1214.0

⁽¹⁾Maximum shaft or housing fillet radius that bearing corners will clear.

⁽²⁾Bearing includes special features; contact your Timken engineer for details.

TYPE TPS

- Two or three cylindrical rollers per cage pocket to enhance true rolling motion and prevent roller skewing.
- Similar to type TP except one washer is spherically ground to seat against an aligning ring which makes the bearing assembly adaptable to initial misalignment.
- Not suggested for operating conditions where alignment is constantly changing.

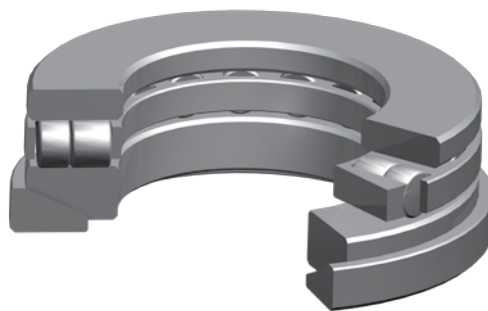

Fig. 64. Type TPS thrust cylindrical roller bearing.

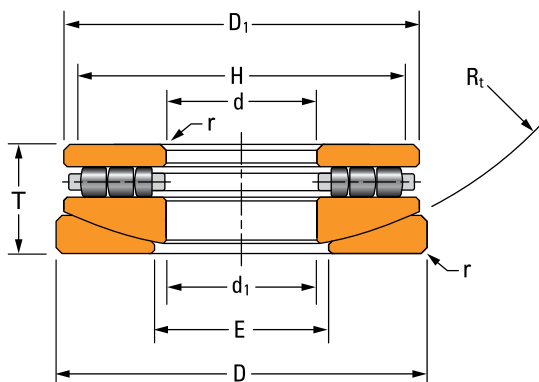

Fig. 65. Type TPS thrust cylindrical roller bearing assembly.

OVERALL DIMENSIONS:

- d – Bore diameter
- D – Bearing O.D.
- T – Bearing width
- R_t – Aligning ring radius
- d_1 – Large bore I.D.
- D_1 – Small diameter O.D.
- E – Housing shoulder diameter
- H – Shaft shoulder diameter
- r – Shaft/housing maximum fillet radius

THRUST BEARING DATA

THRUST CYLINDRICAL ROLLER BEARING – TYPE TPS

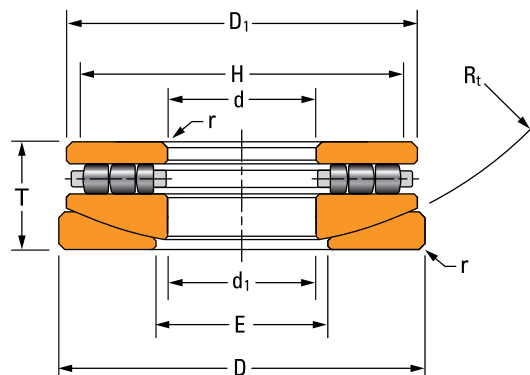
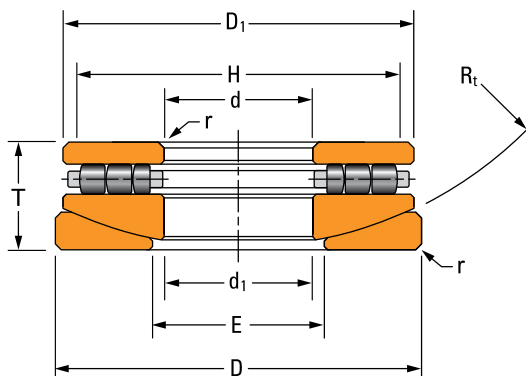

TABLE 42. THRUST CYLINDRICAL ROLLER BEARING – TYPE TPS

Bearing Number	Bearing Dimensions			Rings			Shoulder Diameter		Fillet ⁽¹⁾ Radius (Max.) r	Load Rating		Limiting Speed RPM	Bearing Weight kg lbs.
	Bore	O.D.	Width	Aligning Washer Radius	Small Diameter O.D.	Large Bore I.D.	Shaft (Min.)	Housing (Max.)		Static Load Rating	Dynamic Load Rating		
	d	D	T	R _t	D ₁	d ₁	H	E		C _{a0}	C _a		
	mm in.	mm in.	mm in.	mm in.	mm in.	mm in.	mm in.	mm in.	mm in.	kN lbf.	kN lbf.		kg lbs.
20TPS103	50.800 2.0000	160.325 6.3120	46.038 1.8125	190.50 7.500	150.81 5.938	52.39 2.062	141.3 5.56	85.7 3.38	1.6 0.06	1400 315400	400 83600	1900	5.2 11.4
20TPS104	50.800 2.0000	185.725 7.3120	46.038 1.8125	241.30 9.500	176.21 6.938	52.39 2.062	163.5 6.44	108.0 4.25	1.6 0.06	1700 384200	400 95000	1630	7.1 15.7
30TPS106	76.200 3.0000	160.325 6.3120	46.038 1.8125	152.40 6.000	150.81 5.938	77.79 3.062	142.9 5.62	101.6 4.00	1.6 0.06	1200 279500	300 73700	1900	4.5 9.9
30TPS107	76.200 3.0000	185.725 7.3120	46.038 1.8125	241.30 9.500	176.21 6.938	77.79 3.062	166.7 6.56	111.1 4.38	1.6 0.06	1800 401500	400 95500	1630	6.4 14.2
30TPS108	76.200 3.0000	211.125 8.3120	46.038 1.8125	304.80 12.000	201.61 7.938	77.79 3.062	188.9 7.44	133.4 5.25	1.6 0.06	2300 523800	500 114800	1420	8.7 19.2
35TPS113	88.900 3.5000	138.908 5.4688	33.338 1.3125	127.00 5.000	130.97 5.156	91.28 3.594	123.8 4.88	103.2 4.06	1.6 0.06	700 146400	200 36800	2190	1.9 4.1
40TPS114	101.600 4.0000	187.327 7.3750	58.738 2.3125	161.93 6.375	176.21 6.938	103.93 4.094	168.3 6.62	127.0 5.00	1.6 0.06	1700 372500	400 96500	1630	7.0 15.4
40TPS115	101.600 4.0000	212.725 8.3750	58.738 2.3125	215.90 8.500	201.61 7.938	103.98 4.094	190.5 7.50	133.4 5.25	1.6 0.06	2300 515700	500 122000	1420	10.0 22.1
40TPS116	101.600 4.0000	238.125 9.3750	58.738 2.3125	254.00 10.000	227.01 8.938	103.98 4.094	214.3 8.44	149.2 5.88	1.6 0.06	3000 683500	700 149200	1260	13.4 29.5
40TPS117	101.600 4.0000	266.700 10.5000	58.738 2.3125	355.60 14.000	252.41 9.938	103.98 4.094	238.1 9.38	165.1 6.50	1.6 0.06	3700 827600	800 171400	1140	17.1 37.7
50TPS119	127.000 5.0000	215.900 8.5000	58.738 2.3125	187.33 7.375	201.61 7.938	130.18 5.125	190.5 7.50	152.4 6.00	1.6 0.06	2100 465800	500 109800	1420	8.4 18.5
50TPS120	127.000 5.0000	241.300 9.5000	58.738 2.3125	266.70 10.500	227.01 8.938	130.18 5.125	215.9 8.50	155.6 6.12	1.6 0.06	2900 645200	600 139300	1260	11.8 26.1
50TPS121	127.000 5.0000	266.700 10.5000	66.675 2.6250	323.85 12.750	252.41 9.938	130.18 5.125	239.7 9.44	158.8 6.25	3.2 0.12	3700 835900	800 182600	1140	17.6 38.7
50TPS122	127.000 5.0000	292.100 11.5000	66.675 2.6250	406.40 16.000	277.81 10.938	130.18 5.125	261.9 10.31	177.8 7.00	3.2 0.12	4800 1073500	1000 218400	1030	22.1 48.8
50TPS123	127.000 5.0000	317.500 12.5000	66.675 2.6250	501.65 19.750	303.21 11.938	130.18 5.125	288.9 11.38	184.1 7.25	3.2 0.12	5600 1248900	1100 242600	950	27.2 60.0
60TPS124	152.400 6.0000	241.300 9.5000	66.675 2.6250	171.45 6.750	227.01 8.938	155.58 6.125	217.5 8.56	184.1 7.25	3.2 0.12	2400 543800	600 130200	1260	10.8 23.8

⁽¹⁾Maximum shaft or housing fillet radius that bearing corners will clear.

Continued on next page.



Continued from previous page.

Bearing Number	Bearing Dimensions			Rings			Shoulder Diameter		Fillet ⁽¹⁾ Radius (Max.)	Load Rating		Limiting Speed	Bearing Weight
	Bore	O.D.	Width	Aligning Washer Radius	Small Diameter O.D.	Large Bore I.D.	Shaft (Min.)	Housing (Max.)		Static Load Rating	Dynamic Load Rating		
	d	D	T	R _t	D ₁	d ₁	H	E	C _{a0}	C _a	RPM	kg lbs.	
60TPS125	152.400 6.0000	266.700 10.5000	66.675 2.6250	241.30 9.500	252.46 9.938	155.58 6.125	241.3 9.50	187.3 7.38	3.2 0.12	3300 738800	700 162900	1140	15.2 33.5
60TPS126	152.400 6.0000	292.100 11.5000	66.675 2.6250	342.90 13.500	277.81 10.938	155.58 6.125	265.1 10.44	187.3 7.38	3.2 0.12	4600 1032600	900 208300	1030	20.1 44.3
60TPS127	152.400 6.0000	317.500 12.5000	66.675 2.6250	431.80 17.000	303.21 11.938	155.58 6.125	287.3 11.31	190.5 7.50	3.2 0.12	5600 1252500	1100 240600	950	25.2 55.6
70TPS129	177.800 7.0000	266.700 10.5000	66.675 2.6250	206.38 8.125	251.62 9.906	180.80 7.125	242.9 9.56	206.4 8.12	3.2 0.12	2800 625400	600 140700	1140	12.7 27.9
70TPS130	177.800 7.0000	292.100 11.5000	66.975 2.6250	292.10 11.500	277.02 10.906	180.98 7.125	266.7 10.50	209.6 8.25	3.2 0.12	3900 886500	800 182100	1030	17.7 39.1
70TPS131	177.800 7.0000	317.500 12.5000	66.675 2.6250	390.53 15.375	302.42 11.906	180.98 7.125	288.9 11.38	209.6 8.25	3.2 0.12	5200 1180100	1000 224800	950	23.3 51.3
70TPS132	177.800 7.0000	374.650 14.7500	101.600 4.0000	390.53 15.375	353.22 13.906	180.98 7.125	335.0 13.19	228.6 9.00	6.4 0.25	7500 1692700	1700 371200	810	52.6 115.9
80TPS134	203.200 8.0000	323.850 12.7500	101.600 4.0000	215.90 8.500	302.42 11.906	207.96 8.188	292.1 11.50	238.1 9.38	6.4 0.25	4500 1016000	1100 251800	950	29.8 65.8
80TPS135	203.200 8.0000	374.650 14.7500	101.600 4.0000	304.80 12.000	353.22 13.906	207.96 8.188	336.6 13.25	263.5 10.38	6.4 0.25	6900 1558900	1500 343800	810	47.7 105.2
80TPS136	203.200 8.0000	428.625 16.8750	101.600 4.0000	495.30 19.500	404.02 15.906	209.55 8.250	382.6 15.06	266.7 10.50	6.4 0.25	9300 2091300	1900 423600	710	68.2 150.4
90TPS139	228.600 9.0000	374.650 14.7500	101.600 4.0000	304.80 12.000	353.22 13.906	234.95 9.250	339.7 13.38	263.5 10.38	6.4 0.25	6800 1524300	1500 333400	810	42.2 93.1
90TPS140	228.600 9.0000	428.625 16.8750	101.600 4.0000	495.30 19.500	404.02 15.906	234.95 9.250	385.8 15.19	266.7 10.50	6.4 0.25	9400 2115800	1900 422200	710	63.3 139.5
100TPS143	254.000 10.0000	428.625 16.8750	101.600 4.0000	425.45 16.750	404.02 15.906	260.36 10.250	387.4 15.25	292.1 11.50	6.4 0.25	8500 1905400	1700 384700	710	56.2 124.0
100TPS144	254.000 10.0000	479.425 18.8750	127.000 5.0000	508.00 20.000	454.82 17.906	260.36 10.250	435.0 17.12	304.8 12.00	6.4 0.25	12000 2702600	2500 556000	630	99.5 219.5
100TPS145	254.000 10.0000	530.225 20.8750	127.000 5.0000	609.60 24.000	505.62 19.906	260.36 10.250	481.0 18.94	336.6 13.25	6.4 0.25	15600 3512400	3000 670600	570	131.8 290.6
120TPS151	304.800 12.0000	479.425 18.8750	127.000 5.0000	390.53 15.375	454.82 17.906	311.15 12.250	438.2 17.25	346.1 13.62	6.4 0.25	10800 2423800	2200 500700	630	82.1 181.0

⁽¹⁾Maximum shaft or housing fillet radius that bearing corners will clear.

Continued on next page.

THRUST BEARING DATA

THRUST CYLINDRICAL ROLLER BEARING – TYPE TPS

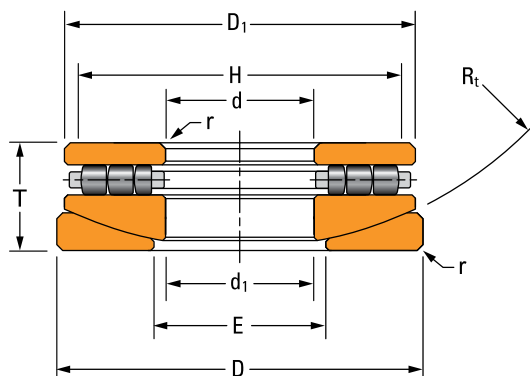

TABLE 42. THRUST CYLINDRICAL ROLLER BEARING – TYPE TPS – continued

Bearing Number	Bearing Dimensions			Rings			Shoulder Diameter		Fillet ⁽¹⁾ Radius (Max.) r	Load Rating		Limiting Speed RPM	Bearing Weight kg lbs.
	Bore	O.D.	Width	Aligning Washer Radius	Small Diameter O.D.	Large Bore I.D.	Shaft (Min.)	Housing (Max.)		Static Load Rating	Dynamic Load Rating		
	d	D	T	R _t	D ₁	d ₁	H	E		C _{a0}	C _a		
	mm in.	mm in.	mm in.	mm in.	mm in.	mm in.	mm in.	mm in.	mm in.	kN lbf.	kN lbf.		kg lbs.
120TPS152	304.800 12.0000	530.225 20.8750	152.400 6.0000	619.13 24.375	505.62 19.906	311.15 12.250	484.2 19.06	352.4 13.88	6.4 0.25	12800 2888000	2800 622300	570	139.4 307.4
120TPS153	304.800 12.0000	631.825 24.8750	152.400 6.0000	723.90 28.500	607.22 23.906	311.15 12.250	584.2 23.00	406.4 16.00	6.4 0.25	21200 4772700	4000 896600	470	236.9 522.4
140TPS158	355.600 14.0000	530.225 20.8750	123.825 4.8750	495.30 19.500	504.82 19.875	361.95 14.250	489.0 19.25	393.7 15.50	6.4 0.25	12500 2801900	2400 543200	570	89.2 196.6
140TPS159	355.600 14.0000	581.025 22.8750	123.825 4.8750	723.90 28.500	555.62 21.875	361.95 14.250	535.0 21.06	393.7 15.50	6.4 0.25	16700 3753400	3000 677200	520	125.0 275.6
140TPS160	355.600 14.0000	631.825 24.8750	123.825 4.8750	917.58 36.125	606.62 23.875	361.95 14.250	581.0 22.88	415.9 16.38	6.4 0.25	21600 4846200	3600 816500	470	170.9 376.9
160TPS164	406.400 16.0000	581.025 22.8750	152.400 6.0000	444.50 17.500	555.62 21.875	412.75 16.250	539.8 21.25	444.5 17.50	6.4 0.25	13400 3009000	2700 616900	520	123.9 273.2
160TPS165	406.400 16.0000	635.000 25.0000	152.400 6.0000	596.90 23.500	606.42 23.875	412.75 16.250	585.8 23.06	457.2 18.00	6.4 0.25	18100 4077300	3400 771600	470	174.4 384.6
160TPS166	406.400 16.0000	685.800 27.0000	152.400 6.0000	752.48 29.625	657.20 25.875	412.75 16.250	633.4 24.94	469.9 18.50	6.4 0.25	23100 5191800	4100 922000	440	229.8 506.7

⁽¹⁾Maximum shaft or housing fillet radius that bearing corners will clear.

THRUST SPHERICAL ROLLER BEARINGS TYPES TSR-EJ AND TSR-EM

- Designed to achieve high thrust capacity with low friction and continuous roller alignment.
- Utilize spherically contoured rollers arranged in a steep angular configuration to accommodate high thrust load alone, or in combination with moderate radial loads.
- Low friction of the bearing results from a combination of bearing geometry and manufacturing technology.
- Possess inherent dynamic misalignment capabilities up to 2.5 degrees between shaft and housing.
- Design variants include bearings with steel cage (EJ) or brass cage (EM).

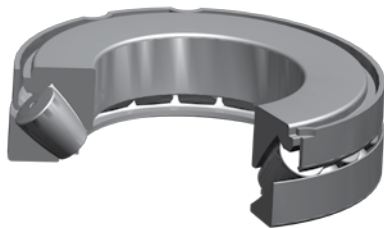

Fig. 66. Type TSR-EJ

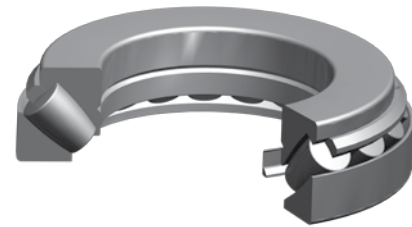

Fig. 67. Type TSR-EM

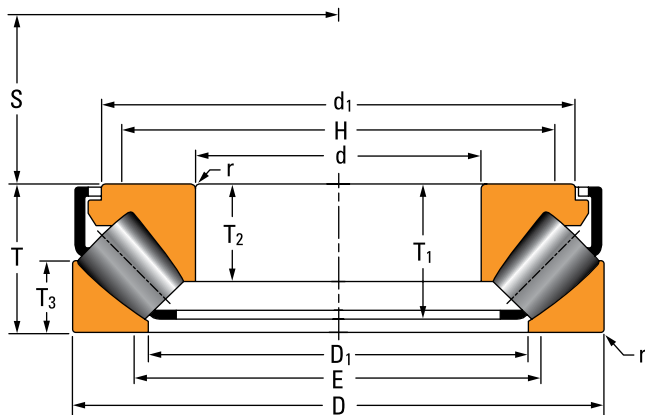

Fig. 68. Type TSR-EJ bearing assembly.

OVERALL DIMENSIONS:

- d – Bore diameter
- D – Bearing O.D.
- d₁ – Inner ring O.D.
- D₁ – Outer ring bore
- T – Bearing width
- T₁ – Inner ring assembly width
- T₂ – Inner ring width
- T₃ – Outer ring width
- E – Housing shoulder diameter
- H – Shaft shoulder diameter
- S – Pivot center location
- r – Shaft/housing maximum fillet radius

DESIGN TYPES

TSR-EJ

- Spherical inner and outer races.
- Utilizes window-type steel cage which unitizes the cage and roller assembly with the inner ring via cage tabs.
- Optimized internal geometry, roller design and surface finishing to minimize torque and heat generation, improve lubrication, and maximize load capacity.

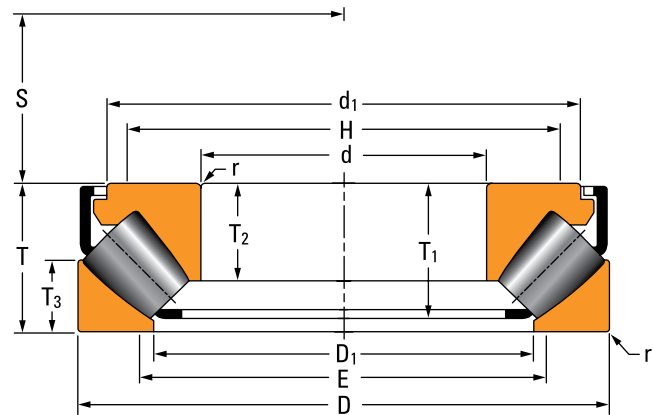

Fig. 69. Type TSR-EJ

TSR-EM

- Spherical inner and outer races.
- Utilizes large end roller-riding brass cage design which enhances lubrication flow and enables maximized roller length to provide high thrust load capacity within the envelope.
- Roller-cage assembly is unitized to the inner ring via a steel cage band for easier bearing mounting and handling.

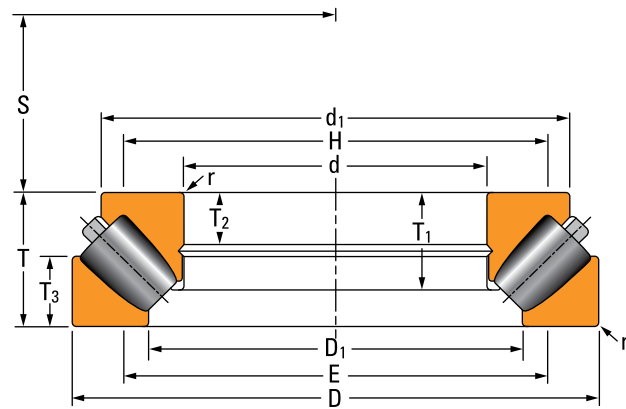
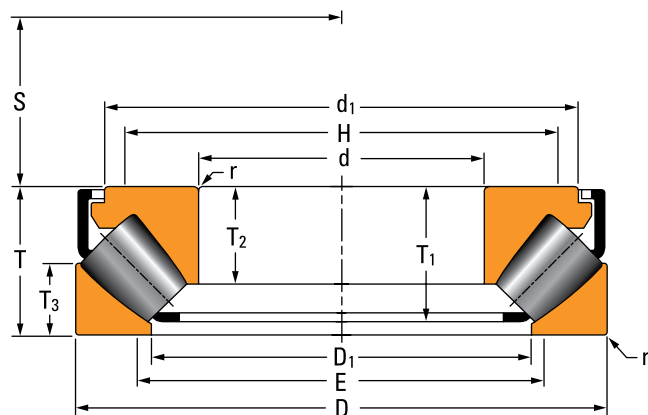

Fig. 70. Type TSR-EM.

TABLE 42A. TIMKEN THRUST SPHERICAL ROLLER BEARING MODIFICATION CODES

Mod Code	Timken General Definition
W8	TDC coated rings & rollers
W16	Special internal features
W18	Inner ring with special squareness and parallelism tolerance
W23	Wide inner ring
W40	Rings and rollers made of carburizing-grade steel
W40B	Rings made of carburizing-grade steel.
W40R	Rollers only made of carburizing-grade steel
W50	Tapped holes in face of inner ring (imperial)
W50B	Tapped holes in face of inner ring (metric)
W57	Wide outer ring
W66	Special tolerances on spacer (where spacer requested)
W98	Inner ring with undersize bore
W896D	W23-Wider inner ring + W57-Wider outer ring
W921	Large chamfer on outer ring bore

THRUST SPHERICAL ROLLER BEARINGS – TYPE TSR-EJ AND TYPE TSR-EM



Type TSR-EJ

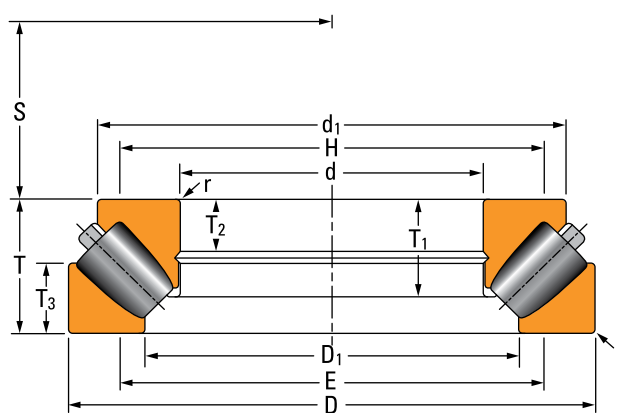

Type TSR-EM

TABLE 43. THRUST SPHERICAL ROLLER BEARINGS

Bearing Number	Bearing Dimensions					Shoulder Diameter		Mounting Dimensions					Load Rating		Thermal Speed Rating	Limiting Speed	Bearing Weight	Kc ⁽²⁾
	Bore	O.D.	Width	Inner Ring O.D.	Outer Ring Bore	Housing (Max.)	Shaft (Min.)				Fillet ⁽¹⁾ Radius (Max.)	Static Load Rating	Dynamic Load Rating					
	d	D	T	d ₁	D ₁	E	H	T ₁	T ₂	T ₃	S	r	C _{a0}	C _a				
mm in.	mm in.	mm in.	mm in.	mm in.	mm in.	mm in.	mm in.	mm in.	mm in.	mm in.	mm in.	mm in.	kN lbf.	kN lbf.	RPM	RPM	kg lbs.	
29418EJ	90 3.5433	190 7.4803	60 2.3622	164.6 6.48	127.5 5.02	137 5.39	148 5.83	51.9 2.04	39 1.54	28.5 1.12	56 2.2	2 0.08	1890 426000	820 184000	2000	3410	7.4 16.3	20
29320EJ	100 3.937	170 6.6929	42 1.6535	152.3 6	127.5 5.02	134 5.28	141 5.55	35.4 1.39	26.2 1.03	20.5 0.81	58 2.28	1.5 0.06	1240 278000	462 104000	2000	3540	3.5 7.7	10
29420EJ	100 3.937	210 8.2677	67 2.6378	182.2 7.17	141.5 5.57	151 5.94	164 6.46	58 2.28	43 1.69	32 1.26	62 2.44	2.5 0.1	2390 536000	1020 230000	1800	3080	10.1 22.4	40
29322EJ	110 4.3307	190 7.4803	48 1.8908	171.1 6.74	140 5.51	149 5.87	157 6.18	40.3 1.59	30.3 1.19	24.8 0.98	63.8 2.51	2 0.08	1660 372000	604 136000	1800	3180	4.7 10.5	15
29422EJ	110 4.3307	230 9.0551	73 2.874	199.4 7.85	155.5 6.12	167 6.57	180 7.09	63.2 2.49	47 1.85	34.7 1.37	69 2.72	2.5 0.1	2840 638000	1200 269000	1700	2810	13.2 29.1	45
29324EJ	120 4.7244	210 8.2677	54 2.126	188.1 7.41	154 6.06	163 6.42	172 6.77	46 1.81	34 1.34	27 1.06	70 2.76	2 0.08	2070 466000	768 173000	1700	2890	7.2 15.8	25
29424EJ	120 4.7244	250 9.8425	78 3.0709	216.8 8.54	171 6.73	182 7.17	197 7.76	68.5 2.7	50.5 1.99	36.5 1.44	74 2.92	3 0.12	3320 746000	1390 312000	1500	2580	16.6 36.7	60
29326EJ	130 5.1181	225 8.8583	58 2.2835	203.4 8.01	165.5 6.52	177 6.97	186 7.32	48.6 1.91	36.7 1.44	30.1 1.19	75.6 2.98	2 0.08	2410 543000	852 192000	1600	2690	8.8 19.4	25
29426EJ	130 5.1181	270 10.6299	85 3.3464	234.4 9.23	184.5 7.26	197 7.76	213 8.39	72.7 2.86	54 2.13	40.9 1.61	81 3.19	3 0.12	3870 871000	1600 359000	1400	2390	20.9 46	80
29328EJ	140 5.5118	240 9.4488	60 2.3622	216.1 8.51	177 6.97	188 7.4	199 7.83	51.7 2.04	38.5 1.52	30 1.18	82 3.23	2 0.08	2710 609000	970 218000	1500	2510	10.2 22.5	40
29428EJ	140 5.5118	280 11.0236	85 3.3464	245.4 9.66	194.5 7.66	207 8.15	223 8.78	72.9 2.87	54 2.13	41 1.61	86 3.39	3 0.12	4110 924000	1640 369000	1300	2270	22.1 48.6	90
29330EJ	150 5.9055	250 9.8425	60 2.3622	223.9 8.82	190 7.48	198 7.8	209 8.23	52.2 2.06	38 1.5	28 1.1	87 3.43	2 0.08	2760 620000	993 223000	1400	2390	10.6 23.3	45
29430EJ	150 5.9055	300 11.811	90 3.5433	262.9 10.35	207.5 8.17	222 8.74	238 9.37	78.3 3.08	58 2.28	43.4 1.71	92 3.62	3 0.12	4730 1060000	1860 418000	1200	2120	27 59.5	115
29332EJ	160 6.2992	270 10.6299	67 2.6378	243.5 9.59	203 7.99	213 8.39	225 8.86	57.4 2.26	42 1.65	33 1.3	92 3.62	2.5 0.1	3370 758000	1190 267000	1300	2220	14.2 31.2	60
29432EJ	160 6.2992	320 12.5984	95 3.7402	279.3 11	223.5 8.8	237 9.33	255 10.04	82.2 3.24	60.5 2.38	45.5 1.79	99 3.9	4 0.16	5340 1200000	2100 472000	1200	1990	32 70.6	150
29334EJ	170 6.6929	280 11.0236	67 2.6378	251.2 9.89	215 8.46	223 8.78	235 9.25	58.6 2.31	42.2 1.66	30.5 1.2	96 3.78	2.5 0.1	3430 770000	1230 277000	1200	2120	14.5 32.1	70

⁽¹⁾Maximum shaft or housing fillet radius that bearing corners will clear.

⁽²⁾Centrifugal force constant for induced thrust load calculation found on page 21.

Continued on next page.

THRUST BEARING DATA

THRUST SPHERICAL ROLLER BEARINGS – TYPE TSR-EJ AND TYPE TSR-EM

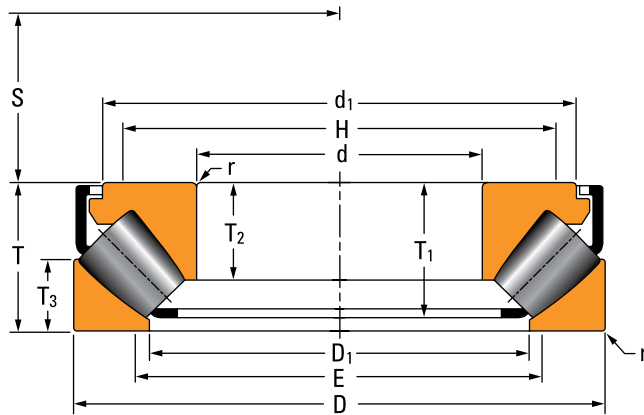

Type TSR-EJ

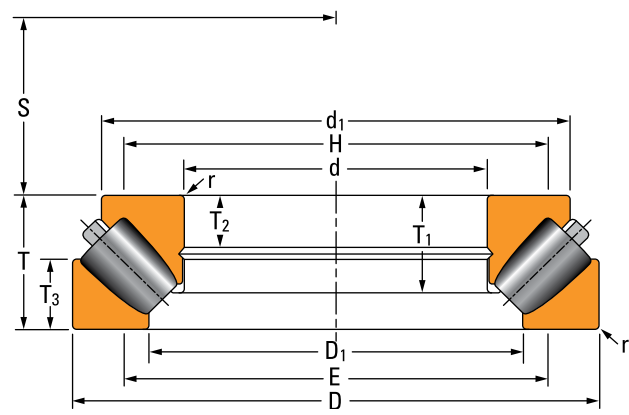

Type TSR-EM

TABLE 43. THRUST SPHERICAL ROLLER BEARINGS – continued

Bearing Number	Bearing Dimensions					Shoulder Diameter		Mounting Dimensions					Load Rating		Thermal Speed Rating	Limiting Speed	Bearing Weight	Kc ⁽²⁾
	Bore	O.D.	Width	Inner Ring O.D.	Outer Ring Bore	Housing (Max.)	Shaft (Min.)				Fillet ⁽¹⁾ Radius (Max.)	Static Load Rating	Dynamic Load Rating					
	d	D	T	d ₁	D ₁	E	H	T ₁	T ₂	T ₃	S	r	C ₁₀	C _a				
mm	mm	mm	mm	mm	mm	mm	mm	mm	mm	mm	mm	mm	kN	kN	RPM	RPM	kg	lbs.
29434EJ	170 6.6929	340 13.3858	103 4.0551	297.7 11.72	236 9.29	251 9.88	270 10.63	89 3.5	65.5 2.58	50 1.97	104 4.09	4 0.16	6140 1380000	2380 536000	1100	1870	39.7 87.4	195
29336EJ	180 7.0866	300 11.811	73 2.875	270 10.63	227 8.94	238 9.37	251 9.88	62.7 2.47	46 1.81	35.5 1.4	103 4.06	2.5 0.1	4130 927000	1430 322000	1200	1990	18.6 41.1	90
29436EJ	180 7.0866	360 14.1732	109 4.2913	315.9 12.44	250 9.84	267 10.51	286 11.26	94.1 3.7	69.5 2.74	53 2.09	110 4.33	4 0.16	7090 1590000	2660 598000	990	1770	47.5 104.7	245
29338EJ	190 7.4803	320 12.5984	78 3.076	285.6 11.25	243.5 9.59	253 9.96	268 10.55	67.7 2.66	49 1.93	36 1.42	110 4.33	3 0.12	4550 1020000	1620 364000	1100	1870	22.5 49.6	120
29438EJ	190 7.4803	380 14.9606	115 4.5276	332.9 13.11	264.5 10.41	281 11.06	303 11.93	100.3 3.95	73 2.87	55.5 2.19	117 4.61	4 0.16	7910 1780000	3040 683000	930	1680	55.7 122.9	320
29340EJ	200 7.874	340 13.3858	85 3.348	304.3 11.98	257 10.12	269 10.59	284 11.18	73.9 2.91	53.5 2.11	40 1.57	116 4.57	3 0.12	5370 1210000	1880 423000	1000	1770	28.4 62.7	155
29440EJ	200 7.874	400 15.748	122 4.8031	350.7 13.81	277.5 10.93	295 11.61	317 12.48	104.2 4.1	77 3.03	59.4 2.34	122 4.8	4 0.16	8470 1900000	3210 723000	900	1590	64.8 142.8	370
29344EJ	220 8.6614	360 14.1716	85 3.3477	326.3 12.85	273.5 10.77	288 11.34	303 11.93	74.1 2.92	55 2.17	41 1.61	125 4.92	3 0.12	5840 1310000	1950 437000	960	1650	30.7 67.6	175
29444EJ	220 8.6614	420 16.5354	122 4.8031	371.6 14.63	300 11.81	317 12.48	339 13.35	105.7 4.16	77 3.03	58.5 2.3	132 5.2	5 0.2	9090 2040000	3350 754000	830	1490	69.4 153.1	435
29348EJ	240 9.4488	380 14.9606	85 3.3477	345.1 13.59	295.5 11.63	308 12.13	323 12.72	74.4 2.93	54 2.13	40.5 1.59	135 5.32	3 0.12	6280 1410000	2040 458000	870	1540	32.8 72.4	210
29448EJ	240 9.4488	440 17.3228	122 4.8031	391.6 15.42	322 12.68	338 13.31	360 14.17	104.7 4.12	76 2.99	59 2.32	142 5.59	5 0.2	9520 2140000	3410 767000	770	1400	73.3 161.6	490
29352EJ	260 10.2362	420 16.5354	95 3.7402	382.2 15.05	324 12.76	340 13.39	356 14.02	84.7 3.33	61 2.4	46 1.81	148 5.83	4 0.16	8100 1820000	2580 579000	790	1400	46.9 103.4	330
29452EJ	260 10.2362	480 18.8976	132 5.1969	427.9 16.85	346 13.62	367 14.45	391 15.39	116.9 4.6	86 3.39	63 2.48	154 6.06	5 0.2	11900 2680000	4160 935000	690	1290	96.4 212.4	715
29356EJ	280 11.0236	440 17.3228	95 3.7418	401 15.79	343 13.5	360 14.17	376 14.8	84.7 3.33	62 2.44	45.5 1.79	158 6.22	4 0.16	8500 1910000	2580 580000	740	1330	49.5 109	355
29456EJ	280 11.0236	520 20.4724	145 5.7148	464.3 18.28	372 14.65	397 15.63	423 16.65	128.9 5.07	95 3.74	70 2.76	166 6.54	5 0.2	14300 3220000	4920 1110000	630	1190	126.3 278.3	1000
29360EJ	300 11.811	480 18.8978	109 4.2929	434.1 17.09	372 14.65	388 15.28	407 16.02	95.5 3.76	70 2.76	51 2.01	168 6.61	4 0.16	9900 2230000	3150 709000	690	1220	67.3 148.4	530

⁽¹⁾Maximum shaft or housing fillet radius that bearing corners will clear.

⁽²⁾Centrifugal force constant for induced thrust load calculation found on page 21.

Continued on next page.

THRUST SPHERICAL ROLLER BEARINGS – TYPE TSR-EJ AND TYPE TSR-EM

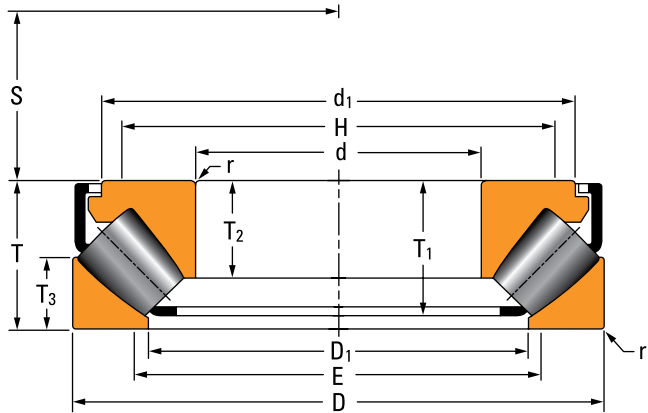

Type TSR-EJ

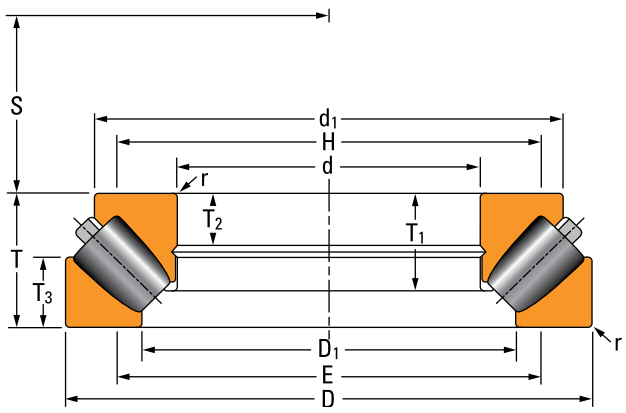

Type TSR-EM

Continued from previous page.

Table with columns: Bearing Number, Bearing Dimensions (Bore, O.D., Width, Inner Ring O.D., Outer Ring Bore), Shoulder Diameter (Housing, Shaft), Mounting Dimensions (T1, T2, T3, S, Fillet Radius), Load Rating (Static, Dynamic), Thermal Speed Rating, Limiting Speed, Bearing Weight, Kc. Rows include models like 29460EJ, 29364EJ, 29464EM, etc.

(1)Maximum shaft or housing fillet radius that bearing corners will clear.

(2)Centrifugal force constant for induced thrust load calculation found on page 21.

Continued on next page.

THRUST BEARING DATA

THRUST SPHERICAL ROLLER BEARINGS – TYPE TSR-EJ AND TYPE TSR-EM

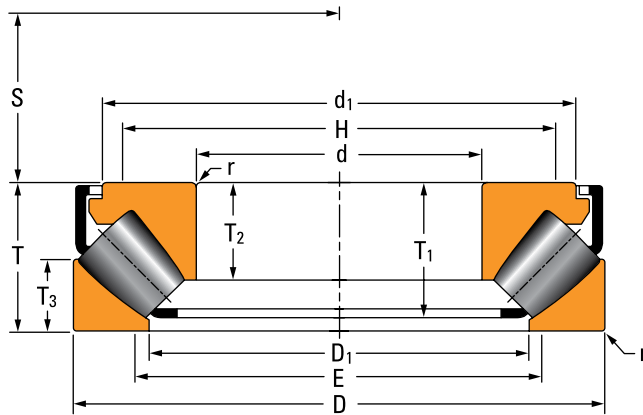

Type TSR-EJ

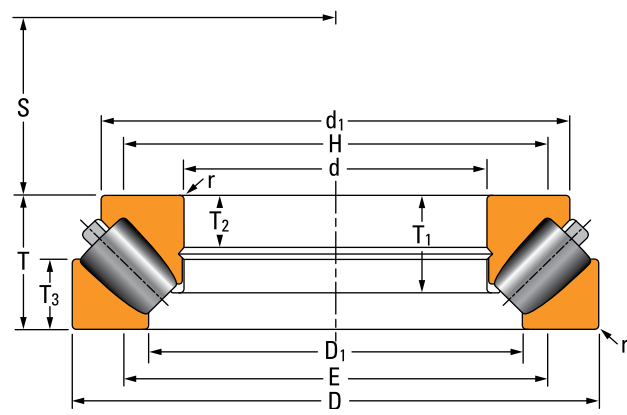

Type TSR-EM

TABLE 43. THRUST SPHERICAL ROLLER BEARINGS – continued

Bearing Number	Bearing Dimensions					Shoulder Diameter		Mounting Dimensions					Load Rating		Thermal Speed Rating	Limiting Speed	Bearing Weight	Kc ⁽²⁾
	Bore	O.D.	Width	Inner Ring O.D.	Outer Ring Bore	Housing (Max.)	Shaft (Min.)	T ₁	T ₂	T ₃	S	Fillet ⁽¹⁾ Radius (Max.) r	Static Load Rating	Dynamic Load Rating				
	d	D	T	d ₁	D ₁	E	H						C _{a0}	C _a				
mm in.	mm in.	mm in.	mm in.	mm in.	mm in.	mm in.	mm in.	mm in.	mm in.	mm in.	mm in.	mm in.	kN lbf.	kN lbf.	RPM	RPM	kg lbs.	
29392EM	460 18.1102	710 27.9528	150 5.9055	660 25.98	567 22.32	589 23.19	614 24.17	105.3 4.15	55 2.17	72.5 2.85	257 10.12	5 0.2	20200 4540000	4820 1080000	450	820	193.6 426.8	2165
29492EM	460 18.1102	800 31.4961	206 8.1102	735 28.94	596 23.46	631 24.84	666 26.22	147.8 5.82	77 3.03	101.5 4	268 10.55	8 0.31	31700 7120000	8120 1830000	380	760	396.5 874.2	4875
29396EM	480 18.8976	730 28.7402	150 5.9055	680 26.77	591 23.27	610 24.02	635 25	101.6 4	54 2.13	73.5 2.89	270 10.63	5 0.2	20000 4500000	4820 1080000	440	790	196.5 433.2	2305
29496EM	480 18.8976	850 33.4646	224 8.8189	780 30.71	625 24.61	662 26.06	700 27.56	161.5 6.36	88 3.46	108 4.25	280 11.02	8 0.31	35800 8040000	9320 2090000	360	720	493.1 1087.2	6335
293/500EM	500 19.685	750 29.5276	150 5.9055	700 27.56	611 24.06	630 24.8	655 25.79	101.5 4	54 2.13	74 2.91	280 11.02	5 0.2	20500 4620000	4840 1090000	430	760	202.9 447.4	2420
294/500EM	500 19.685	870 34.252	224 8.8189	779 30.67	620 24.41	677 26.65	712 28.03	163 6.42	95.5 3.76	118 4.65	293 11.54	8 0.31	42370 9525000	10360 2328000	320	700	544 1200	7070
293/530EM	530 20.8661	800 31.4961	160 6.2992	745 29.33	648 25.51	670 26.38	697 27.44	112.3 4.42	58 2.28	76 2.99	295 11.61	6 0.24	24100 5410000	5600 1260000	390	720	251.1 553.6	3220
294/530EM	530 20.8661	920 36.2205	236 9.2913	823 32.4	657 25.87	716 28.19	753 29.65	171.4 6.75	93.7 3.69	124 4.88	310 12.21	8 0.31	47120 10593000	11440 2572000	300	660	609.5 1343.8	8830
293/560EM	560 22.0472	850 33.4646	175 6.8898	790 31.1	690 27.17	712 28.03	740 29.13	119.1 4.69	63 2.48	85 3.35	310 12.21	6 0.24	26600 5990000	6180 1390000	370	680	309.8 683	4055
294/560EM	560 22.0472	980 38.5827	250 9.8425	876 34.89	693 27.28	759 29.88	798.1 31.42	183.2 7.21	106.5 4.19	134 6.28	328 12.91	10 0.39	54370 12222000	13010 2926000	280	620	744.1 1640.4	11425
292/600EM	600 23.622	800 31.4961	122 4.8031	750 29.53	677 26.65	699 27.52	718 28.27	82.9 3.26	40.6 1.598	64 2.52	322 12.68	4 0.16	21920 4927000	4370 981600	400	680	152 335.1	2355
293/600EM	600 23.622	900 35.4331	180 7.0946	840 33.07	720 28.35	751 29.57	780 30.71	127.3 5.01	65 2.56	89 3.5	335 13.19	6 0.24	32700 7360000	7380 1660000	330	640	361.1 796.2	5465
294/600EM	600 23.622	1030 40.5512	258 10.1575	922 36.3	744 29.29	805 31.69	847.1 33.35	186 7.32	107 4.21	134 5.28	351 13.82	10 0.39	57530 12933000	13840 3112000	260	590	822.3 1814.1	13750
292/630EM	630 24.803	850 33.4646	132 5.1968	796 31.34	712 28.03	759 29.88	738 29.06	90.3 3.56	43.9 1.73	71.5 2.82	338 13.31	5 0.2	25800 5800000	5040 1133000	380	650	195 430	3090
294/630EM	630 24.803	1090 42.9134	280 11.0236	975 38.39	780 30.71	849 33.43	893.1 35.16	203.1 8	114.2 4.5	146 5.75	367 14.45	10 0.39	65910 14816000	15640 3515000	240	560	1011.5 2230.1	17420
292/670EM	670 26.378	900 35.4331	140 5.5118	865 34.06	773 30.43	792 31.18	813 32.01	89.5 3.52	44 1.73	73 2.87	363 14.29	5 0.2	22000 4940000	4290 965000	410	610	218.5 481.8	2790

(1) Maximum shaft or housing fillet radius that bearing corners will clear.

(2) Centrifugal force constant for induced thrust load calculation found on page 21.

Continued on next page.

THRUST SPHERICAL ROLLER BEARINGS – TYPE TSR-EJ AND TYPE TSR-EM

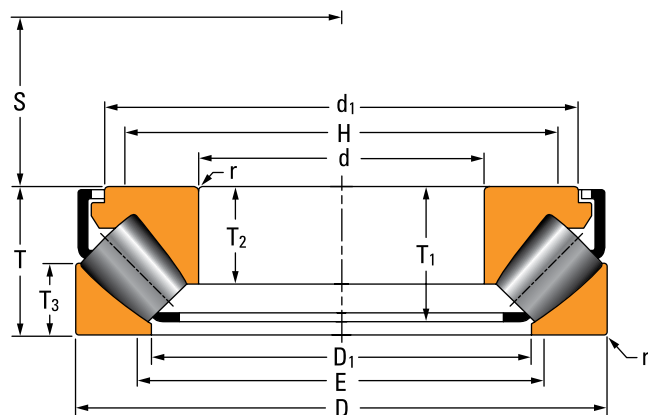

Type TSR-EJ

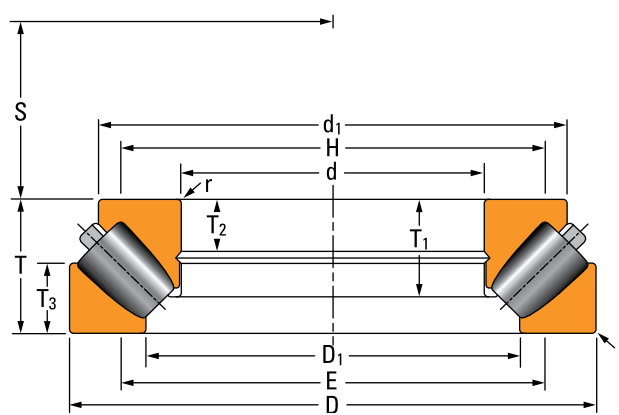

Type TSR-EM

Continued from previous page.

Bearing Number	Bearing Dimensions					Shoulder Diameter		Mounting Dimensions					Load Rating		Thermal Speed Rating	Limiting Speed	Bearing Weight	Kc ⁽²⁾
	Bore	O.D.	Width	Inner Ring O.D.	Outer Ring Bore	Housing (Max.)	Shaft (Min.)				Fillet ⁽¹⁾ Radius (Max.)	Static Load Rating	Dynamic Load Rating					
	d	D	T	d ₁	D ₁	E	H	T ₁	T ₂	T ₃	S	r	C _{a0}	C _a				
mm in.	mm in.	mm in.	mm in.	mm in.	mm in.	mm in.	mm in.	mm in.	mm in.	mm in.	mm in.	mm in.	kN lbf.	kN lbf.	RPM	RPM	kg lbs.	
292/670EJ	670 26.378	900 35.4331	140 5.5118	838.2 33	773 30.43	792 31.18	813 32.01	111.1 4.37	94 3.7	73 2.87	363 14.29	5 0.2	23100 5190000	4450 1000000	370	610	224 493.7	2925
294/670EM	670 26.378	1150 45.2756	290 11.4173	1029 40.51	830 32.68	899 35.39	946 37.24	209.3 8.24	118 4.65	150 5.91	391 15.39	12 0.47	71970 16179000	17030 3829000	230	530	1159.4 2538.3	21420
294/710EM	710 27.9528	1220 48.0315	308 12.126	1092 42.99	879 34.61	953 37.52	1003 39.49	222.6 8.76	122.7 4.83	160 6.3	414 16.3	12 0.47	81300 18276000	19060 4284000	210	500	1379.3 3040.8	27180
293/750EM	750 29.5276	1120 44.0945	224 8.8189	1028 40.47	884 34.8	930 36.61	966 38.03	156.4 6.16	83.3 3.28	117 4.61	418 16.46	8 0.32	55860 12557000	11770 2647000	240	510	699.6 1542.2	14010
294/750EM	750 29.5276	1280 50.3937	315 12.4016	1146 45.12	929 36.58	1002 39.45	1054 41.5	226.8 8.93	130.2 5.13	163 6.42	439 17.28	12 0.47	87900 19761000	20560 4621000	200	470	1537 3388.4	32685
294/800EM	800 31.4961	1360 53.5433	335 13.189	1219 47.99	988 38.9	1067 42.01	1122 44.17	241.6 9.51	131.5 5.18	173.5 6.83	467 18.39	12 0.47	98280 22094000	22700 5104000	190	440	1836 4048	40935
294/850EM	850 33.4646	1440 56.6929	354 13.9402	1290 50.79	1053 41.46	1131 44.53	1190 46.85	253.1 9.96	139.8 5.51	181 7.13	495 19.49	12 0.47	109310 24574000	25250 5677000	170	420	2156 4753	51670
294/850EJ	850 33.4646	1440 56.6929	354 13.9402	1294 50.95	1045 41.14	1129 44.5	1171.1 46.11	309.5 12.18	224.7 8.85	185.5 7.3	495 19.49	12 0.47	112880 25377000	24650 5542000	170	420	2253 4969	50035
294/900EM	900 35.4331	1520 59.8425	372 14.6457	1366 53.78	1098 43.23	1194 47.01	1253 49.33	272.1 10.71	148.8 5.86	195.5 7.7	523 20.59	12 0.47	126950 28540000	27440 6168000	160	400	2561 5646	63350
294/950EM	950 37.4016	1600 62.9921	390 15.3543	1438 56.61	1162 45.75	1259 49.57	1321 52.01	284.6 11.21	155.4 6.12	204 8.03	552 21.73	12 0.47	139020 31253000	30600 6880000	150	370	2962.3 6530.8	77810
292/1000EM	1000 39.3701	1320 51.9685	190 7.4803	1242 48.9	1118 44.02	1157 45.55	1187 46.73	131.1 5.16	68.1 2.68	102 4.02	539 21.22	8 0.31	59110 13288000	10580 2379000	230	410	633.3 1396.2	15850
293/1000EM	1000 39.3701	1460 57.4803	276 10.8661	348 53.07	162 45.75	1268 49.92	1224 48.19	275.8 10.86	104.3 4.11	144.5 5.69	561 22.09	10 0.39	94280 21194000	18520 4163000	140	390	1426 3144	37215
294/1000EM	1000 39.3701	1670 65.748	402 15.8268	1501 59.09	1225 48.23	1319 51.93	1385.1 54.53	289.9 11.41	162 6.38	208.5 8.21	580 22.84	12 0.47	148040 33280000	32590 7326000	140	360	3263.5 7194.7	91560

⁽¹⁾Maximum shaft or housing fillet radius that bearing corners will clear.

⁽²⁾Centrifugal force constant for induced thrust load calculation found on page 21.

THRUST TAPERED ROLLER BEARINGS TYPE TTHD

- Consists of two thrust tapered races, rollers and cage.
- Generally a heavy-duty bearing that can operate at relatively high speeds.
- Bearing of choice for axial positions in a wide variety of applications including oil well swivels, pulp refiners, extruders and piercing mill thrust blocks.

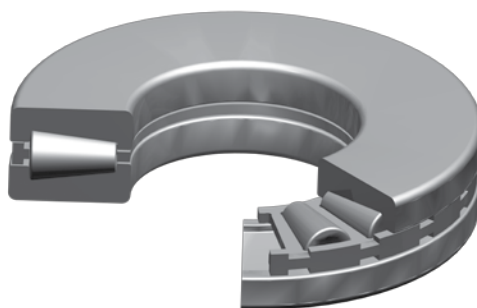

Fig. 71. Type TTHD thrust tapered roller bearing.

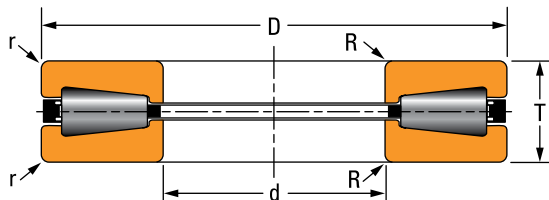

Fig. 72. Type TTHD thrust tapered roller bearing assembly.

OVERALL DIMENSIONS:

- d – Bore diameter
- D – Bearing O.D.
- T – Bearing width
- R – Shaft maximum fillet radius
- r – Housing maximum fillet radius

The design differences between the TTHD configurations shown on pages 94-98 are described as follows:

Fig. 1 – TTHD with full complement of rollers (cageless)

Fig. 2 – TTHD with cage

Fig. 3 – TTHD with cage, but no roller smaller-end ribs

Fig. 4 – TTHD with cage and I.D. corner reliefs

Fig. 5 – TTHD with full complement of rollers (cageless) and I.D. corner reliefs

THRUST BEARING DATA

THRUST TAPERED ROLLER BEARINGS – TYPE TTHD

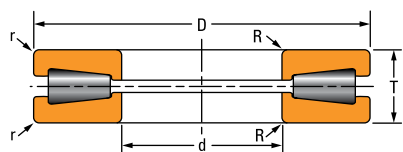

Fig. 1

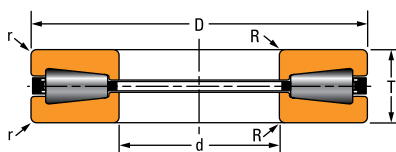

Fig. 2

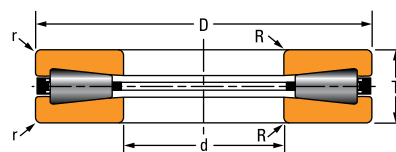

Fig. 3

TABLE 44. THRUST TAPERED ROLLER BEARINGS – TYPE TTHD

Bearing Number	Figure Number	Bearing Dimensions			Fillet Radius ⁽¹⁾		Load Rating		Bearing Weight
		Bore d	O.D. D	Width T	Shaft (Max.) R	Housing (Max.) r	Static Load Rating C _{a0}	Dynamic Load Rating C _{a90}	
		mm in.	mm in.	mm in.	mm in.	mm in.	kN lbf.	kN lbf.	kg lbs.
T135	2	34.925 1.3750	76.200 3.0000	15.875 0.6250	1.5 0.06	1.5 0.06	320 71200	30 7130	0.4 0.8
T135F ⁽³⁾	1	34.925 1.3750	76.200 3.0000	15.875 0.6250	1.5 0.06	1.5 0.06	470 105000	240 53500	0.4 0.9
T1750	2	44.450 1.7500	84.734 3.3360	18.258 0.7188	2.3 0.09	2.3 0.09	430 97700	40 9460	0.5 1.1
T200A	2	50.800 2.0000	109.538 4.3125	22.225 0.8750	2.3 0.09	2.3 0.09	800 181000	70 16400	1.0 2.3
T2520	2	63.500 2.5000	117.475 4.6250	25.400 1.0000	2.3 0.09	2.3 0.09	800 180000	80 16900	1.3 3.0
30TTHD013	3	76.200 3.0000	161.925 6.3750	33.325 1.3120	3.0 0.12	3.0 0.12	1800 405000	170 37900	(2)
T311	2	76.200 3.0000	161.925 6.3750	33.338 1.3215	3.3 0.13	3.3 0.13	1760 395000	150 34200	3.5 7.7
T311F ⁽³⁾	1	76.200 3.0000	161.925 6.3750	33.338 1.3215	3.3 0.13	3.3 0.13	2440 545000	1250 281000	3.5 7.8
T411	2	101.600 4.0000	215.900 8.5000	46.038 1.8125	3.3 0.13	3.3 0.13	3030 682000	250 56800	8.9 19.6
T411F ⁽³⁾	1	101.600 4.0000	215.900 8.5000	46.038 1.8125	3.3 0.13	3.3 0.13	4200 945000	2160 485000	8.9 19.6
T441	2	111.760 4.4000	223.520 8.8000	55.880 2.2000	3.3 0.13	3.3 0.13	3230 727000	270 60700	11.4 25.1
T441F ⁽³⁾	1	111.760 4.4000	223.520 8.8000	55.880 2.2000	3.3 0.13	3.3 0.13	4480 1010000	2300 515000	11.4 25.1
T451	2	114.300 4.5000	250.825 9.8750	53.975 2.1250	4.0 0.16	4.0 0.16	4380 985000	350 79100	14.2 31.3
T520	2	127.000 5.0000	250.825 9.8750	55.563 2.1875	4.8 0.19	4.8 0.19	3700 831000	310 69500	13.9 30.6
F-530-A	3	127.000 5.0000	266.700 10.5000	58.738 2.3125	3.8 0.15	3.8 0.15	4720 1060000	265 60100	(2)
T511	2	127.000 5.0000	266.700 10.5000	58.738 2.3125	4.8 0.19	4.8 0.19	4580 1030000	370 83600	17.0 37.6

⁽¹⁾Maximum shaft or housing fillet radius that bearing corners will clear.

⁽²⁾Contact your Timken engineer for details.

⁽³⁾Published load ratings are breaker-block ratings. Consult your Timken engineer for use in application analysis.

Continued on next page.

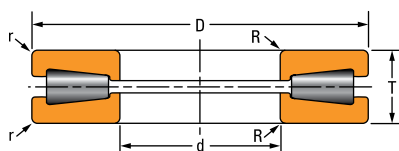

Fig. 1

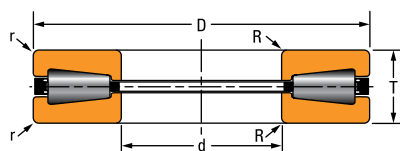

Fig. 2

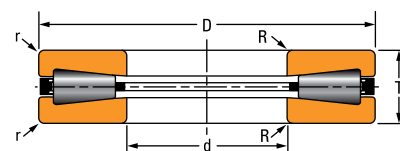

Fig. 3

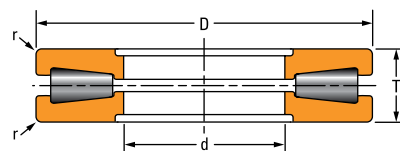

Fig. 5

Continued from previous page.

Bearing Number	Figure Number	Bearing Dimensions			Fillet Radius ⁽¹⁾		Load Rating		Bearing Weight
		Bore	O.D.	Width	Shaft (Max.)	Housing (Max.)	Static Load Rating	Dynamic Load Rating	
		d	D	T	R	r	C _{a0}	C _{a90}	
		mm in.	mm in.	mm in.	mm in.	mm in.	kN lbf.	kN lbf.	kg lbs.
T511F ⁽³⁾	1	127.000 5.0000	266.700 10.5000	58.738 2.3125	4.8 0.19	4.8 0.19	6350 1430000	3260 730000	17.8 39.2
T511A	2	128.588 5.0625	266.700 10.5000	58.738 2.3125	4.8 0.19	4.8 0.19	4580 1030000	370 83600	17.8 39.2
T9250FA ⁽³⁾	5	139.700 5.5000	546.100 21.5000	127.000 5.0000	1.5 0.06	16.0 0.63	31200 7050000	16050 3600000	191.3 421.8
N-3247-A	3	152.400 6.0000	292.100 11.5000	76.200 3.0000	6.4 0.25	6.4 0.25	5120 1150000	370 83680	26.3 58.0
T611	2	152.400 6.0000	317.500 12.5000	69.850 2.7500	6.4 0.25	6.4 0.25	6660 1500000	530 118000	28.4 62.5
T611F ⁽³⁾	1	152.400 6.0000	317.500 12.5000	69.850 2.7500	6.4 0.25	6.4 0.25	9200 2070000	4750 1060000	29.3 64.6
N-3255-A	3	152.400 6.0000	317.500 12.5000	88.900 3.5000	7.9 0.31	7.9 0.31	6810 1530000	470 106200	38.8 85.5
XC2107	2	165.075 6.4990	304.800 12.0000	76.200 3.0000	6.4 0.25	6.4 0.25	5340 1200000	440 99300	26.3 57.9
T651	2	165.100 6.5000	311.150 12.2500	88.900 3.5000	6.4 0.25	6.4 0.25	5730 1290000	470 105000	38.3 84.4
T661	2	168.275 6.6250	304.800 12.0000	69.850 2.7500	6.4 0.25	6.4 0.25	5340 1200000	440 99300	23.5 51.9
T691	2	174.625 6.8750	358.775 14.1250	82.550 3.2500	6.4 0.25	6.4 0.25	7870 1770000	620 139000	43.2 95.2
T711	2	177.800 7.0000	368.300 14.5000	82.550 3.2500	8.0 0.31	8.0 0.31	8950 2010000	690 156000	48.4 106.7
T711F ⁽³⁾	1	177.800 7.0000	368.300 14.5000	82.550 3.2500	8.0 0.31	8.0 0.31	12400 2790000	6350 1430000	48.4 106.7
T709	3	177.800 7.0000	431.800 17.0000	101.600 4.0000	6.4 0.25	6.4 0.25	13600 3060000	1030 231000	86.3 190.3
T7519	2	190.000 7.4803	355.600 14.0000	74.219 2.9220	6.4 0.25	6.4 0.25	6950 1560000	560 127000	35.9 79.2
A-3783-B	3	190.000 7.4803	355.600 14.0000	91.821 3.6150	4.0 0.16	4.0 0.16	8710 1960000	620 139000	49.0 108.0

⁽¹⁾Maximum shaft or housing fillet radius that bearing corners will clear.

⁽²⁾Contact your Timken engineer for details.

⁽³⁾Published load ratings are breaker-block ratings. Consult your Timken engineer for use in application analysis.

Continued on next page.

THRUST BEARING DATA

THRUST TAPERED ROLLER BEARINGS – TYPE TTHD

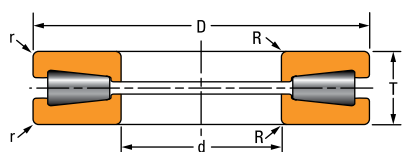

Fig. 1

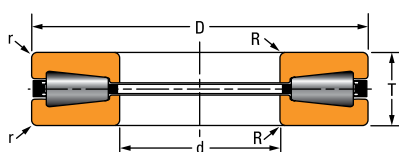

Fig. 2

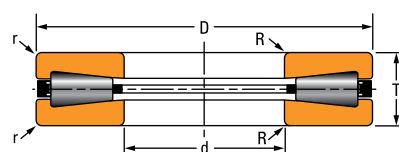

Fig. 3

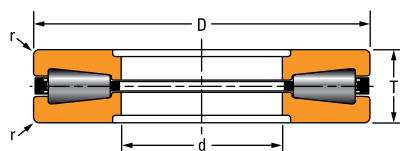

Fig. 4

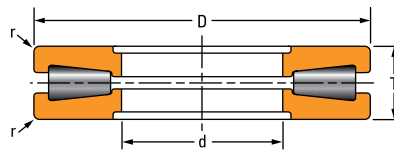

Fig. 5

TABLE 44. THRUST TAPERED ROLLER BEARINGS – TYPE TTHD – continued

Bearing Number	Figure Number	Bearing Dimensions			Fillet Radius ⁽¹⁾		Load Rating		Bearing Weight
		Bore	O.D.	Width	Shaft (Max.)	Housing (Max.)	Static Load Rating	Dynamic Load Rating	
		d	D	T	R	r	C _{a0}	C _{a90}	
		mm in.	mm in.	mm in.	mm in.	mm in.	kN lbf.	kN lbf.	kg lbs.
N-3239-A	3	190.500 7.5000	368.300 14.5000	95.250 3.7500	11.2 0.44	11.2 0.44	9250 2080000	750 169000	53.0 117.0
XC2108	2	203.150 7.9980	396.875 15.6250	130.175 5.1250	9.7 0.38	9.7 0.38	9700 2180000	690 154000	83.7 184.6
T811	2	203.200 8.0000	419.100 16.5000	92.075 3.6250	9.7 0.38	9.7 0.38	11400 2560000	870 195000	65.5 144.3
T811F ⁽³⁾	1	203.200 8.0000	419.100 16.5000	92.075 3.6250	9.7 0.38	9.7 0.38	15750 3540000	8100 1820000	69.3 152.8
T811V	2	203.200 8.0000	419.100 16.5000	92.075 3.6250	9.7 0.38	9.7 0.38	11400 2560000	870 195000	65.5 144.5
N-3263-A	3	206.375 8.1250	419.100 16.5000	120.650 4.7500	11.9 0.47	11.9 0.47	13000 2920000	970 219000	90.7 200.0
XC760	2	206.375 8.1250	419.100 16.5000	120.650 4.7500	9.7 0.38	9.7 0.38	11400 2560000	870 195000	88.2 194.5
T9020	4	228.600 9.0000	431.800 17.0000	88.773 3.4950	1.5 0.06	9.7 0.38	10900 2450000	850 192000	65.7 144.8
T911	4	228.600 9.0000	482.600 19.0000	104.775 4.1250	1.5 0.06	11.2 0.44	15200 3420000	1140 256000	98.3 216.6
T911F ⁽³⁾	5	228.600 9.0000	482.600 19.0000	104.775 4.1250	1.5 0.06	11.2 0.44	21200 4750000	10850 2440000	97.9 215.9
T911A	4	234.950 9.2500	482.600 19.0000	104.775 4.1250	1.5 0.06	11.2 0.44	15200 3420000	1140 256000	103.0 227.1
T921	4	234.950 9.2500	546.100 21.5000	127.000 5.0000	1.5 0.06	16.0 0.63	21300 4780000	1570 353000	171.0 377.0
T921F ⁽³⁾	5	234.950 9.2500	546.100 21.5000	127.000 5.0000	1.5 0.06	16.0 0.63	30000 6750000	15550 3500000	171.0 377.0
T9250F ⁽³⁾	5	234.950 9.2500	546.100 21.5000	127.000 5.0000	1.5 0.06	16.0 0.63	31200 7050000	16050 3600000	164.8 363.4
N-3235-A	3	241.300 9.5000	495.300 19.5000	127.000 5.0000	11.2 0.44	11.2 0.44	18600 4180000	1320 298000	140.0 308.0
N-3517-A	3	241.300 9.5000	495.300 19.5000	127.000 5.0000	12.7 0.50	12.7 0.50	19000 4280000	1590 357000	137.0 303.0

⁽¹⁾Maximum shaft or housing fillet radius that bearing corners will clear.

⁽²⁾Contact your Timken engineer for details.

⁽³⁾Published load ratings are breaker-block ratings. Consult your Timken engineer for use in application analysis.

Continued on next page.

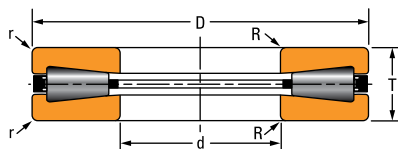

Fig. 3

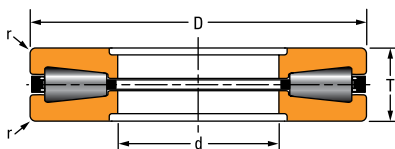

Fig. 4

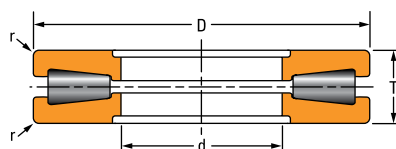

Fig. 5

Continued from previous page.

Bearing Number	Figure Number	Bearing Dimensions			Fillet Radius ⁽¹⁾		Load Rating		Bearing Weight
		Bore	O.D.	Width	Shaft (Max.)	Housing (Max.)	Static Load Rating	Dynamic Load Rating	
		d	D	T	R	r	C _{a0}	C _{a90}	
		mm in.	mm in.	mm in.	mm in.	mm in.	kN lbf.	kN lbf.	kg lbs.
T1011	4	254.000 10.0000	539.750 21.2500	117.475 4.6250	1.5 0.06	11.2 0.44	19400 4350000	1420 319000	147.0 324.1
N-3243-A	3	273.050 10.7500	552.450 21.7500	133.350 5.2500	11.2 0.44	11.2 0.44	22400 5030000	1650 371000	173.0 381.0
N-3259-A	3	273.050 10.7500	566.674 22.3100	177.800 7.0000	14.7 0.58	14.7 0.58	24900 5590000	1750 393000	254.0 559.0
N-3251-A	3	273.050 10.7500	603.250 23.7500	146.050 5.7500	11.2 0.44	11.2 0.44	27700 6230000	2000 449000	240.0 528.0
N-3513-A	3	273.050 10.7500	603.250 23.7500	146.050 5.7500	12.7 0.50	12.7 0.50	27900 6260000	2220 498000	235.0 518.0
T1115	4	279.400 11.0000	495.300 19.5000	133.350 5.2500	1.5 0.06	6.4 0.25	14000 3150000	1090 245000	125.0 275.6
T1120	4	279.400 11.0000	603.250 23.7500	136.525 5.3750	1.5 0.06	11.2 0.44	25300 5690000	1810 408000	212.0 467.4
T1120F ⁽³⁾	5	279.400 11.0000	603.250 23.7500	136.525 5.3750	1.5 0.06	11.2 0.44	35000 7870000	18000 4040000	212.0 467.4
T1421	4	355.600 14.0000	533.400 21.0000	101.600 4.0000	1.5 0.06	6.4 0.25	12100 2710000	840 189000	82.9 182.7
T1421F ⁽³⁾	5	355.600 14.0000	533.400 21.0000	101.600 4.0000	1.5 0.06	6.4 0.25	17200 3870000	8000 1790000	84.1 185.4
G-2308-B	3	355.600 14.0000	622.300 24.5000	115.888 4.5625	11.2 0.44	11.2 0.44	26500 5950000	1860 419000	(2)
T14520	4	368.300 14.5000	603.300 23.7500	120.650 4.7500	1.5 0.06	9.7 0.38	18100 4060000	1420 319000	144.0 317.5
T16021	4	406.400 16.0000	711.200 28.0000	146.050 5.7500	1.5 0.06	9.7 0.38	29000 6530000	2130 480000	259.6 572.4
T16021F ⁽³⁾	5	406.400 16.0000	711.200 28.0000	146.050 5.7500	1.5 0.06	9.7 0.38	38200 8600000	19600 4400000	264.0 582.0
T16050	4	406.400 16.0000	838.200 33.0000	177.800 7.0000	1.5 0.06	12.7 0.50	48000 10800000	3320 747000	517.0 1139.8
T16050F ⁽³⁾	5	406.400 16.0000	838.200 33.0000	177.800 7.0000	1.5 0.06	12.7 0.50	66500 15000000	34200 7650000	501.5 1106.0

⁽¹⁾Maximum shaft or housing fillet radius that bearing corners will clear.

⁽²⁾Contact your Timken engineer for details.

⁽³⁾Published load ratings are breaker-block ratings. Consult your Timken engineer for use in application analysis.

Continued on next page.

THRUST BEARING DATA

THRUST TAPERED ROLLER BEARINGS – TYPE TTHD

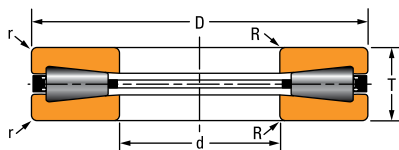

Fig. 3

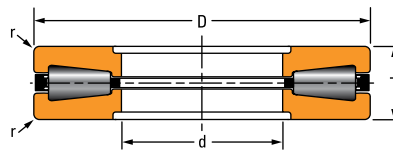

Fig. 4

TABLE 44. THRUST TAPERED ROLLER BEARINGS – TYPE TTHD – *continued*

Bearing Number	Figure Number	Bearing Dimensions			Fillet Radius ⁽¹⁾		Load Rating		Bearing Weight
		Bore d	O.D. D	Width T	Shaft (Max.) R	Housing (Max.) r	Static Load Rating C _{a0}	Dynamic Load Rating C _{a90}	
		mm in.	mm in.	mm in.	mm in.	mm in.	kN lbf.	kN lbf.	kg lbs.
B-8948-G	4	406.400 16.0000	914.400 36.0000	190.500 7.5000	5.0 0.20	5.0 0.20	81000 18200000	5430 1220000	721.0 1590.0
T20020	4	508.000 20.0000	990.600 39.0000	196.850 7.7500	1.5 0.06	1.5 0.06	66700 15000000	4530 1020000	735.0 1620.0
XC2102	3	1003.070 39.4910	1117.600 44.0000	50.800 2.0000	3.3 0.13	3.3 0.13	14900 3350000	530 119000	64.2 141.4
XC2101	3	1162.050 45.7500	1282.700 50.5000	52.388 2.0625	3.3 0.13	3.3 0.13	19000 4280000	620 139000	79.9 176.2
T48000	4	1219.200 48.0000	1524.000 60.0000	136.525 5.3750	1.5 0.06	9.7 0.38	74800 16800000	3450 775000	596.0 1314.0

⁽¹⁾Maximum shaft or housing fillet radius that bearing corners will clear.

⁽²⁾Contact your Timken engineer for details.

⁽³⁾Published load ratings are breaker-block ratings. Consult your Timken engineer for use in application analysis.

TYPE TTHDFL

- Consists of one thrust tapered race, one flat race, rollers and cage.
- Most sizes utilize pin-type cages with hardened pins through the center of the rollers, allowing closer roller spacing to maximize load capacity.
- Smaller sizes have brass cages designed for unidirectional retention of rollers.
- Combines the outstanding features of thrust tapered and cylindrical roller bearings to offer the highest possible load capacity of any thrust bearing of its size.
- Originally developed for screwdown applications in metal rolling mills where high axial loads are common.

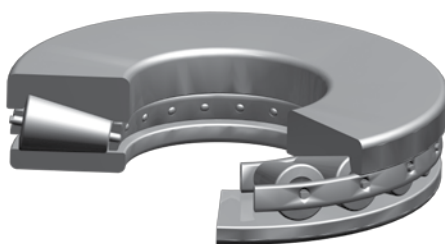

Fig. 73. Type TTHDFL thrust tapered roller bearing.

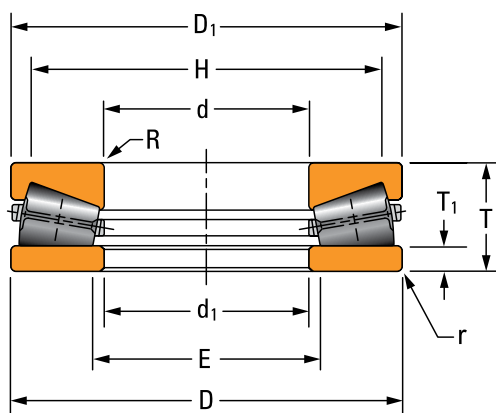

Fig. 74. Type TTHDFL thrust tapered roller bearing assembly.

OVERALL DIMENSIONS:

- d – Bore diameter
- D – Bearing O.D.
- T – Bearing width
- T₁ – Ring thickness
- d₁ – Large bore I.D.
- D₁ – Small diameter O.D.
- E – Housing shoulder diameter
- H – Shaft shoulder diameter
- R – Shaft maximum fillet radius
- r – Housing maximum fillet radius

THRUST BEARING DATA

THRUST TAPERED ROLLER BEARINGS – TYPE TTHDFL

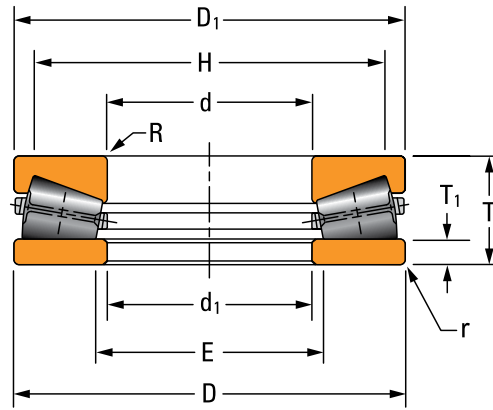

TABLE 45. THRUST TAPERED ROLLER BEARINGS – TYPE TTHDFL

Bearing Number	Bearing Dimensions			Rings			Fillet Radius ⁽¹⁾		Shoulder Diameter		Load Rating		Bearing Weight
	Bore	O.D.	Width	Thickness	Small Diameter O.D.	Large Bore I.D.	Shaft (Max.)	Housing (Max.)	Shaft (Min.)	Housing (Max.)	Static Load Rating	Dynamic Load Rating	
	d	D	T	T ₁	D ₁	d ₁	R	r	H	E	C ₁₀	C ₉₀	
	mm in.	mm in.	mm in.	mm in.	mm in.	mm in.	mm in.	mm in.	mm in.	mm in.	kN lbf.	kN lbf.	kg lbs.
C-8515-A	76.200 3.0000	161.925 6.3750	33.325 1.3120	7.62 0.300	161.93 6.375	76.20 3.000	2.5 0.10	2.5 0.10	150.5 5.93	88.6 3.49	2600 584000	200 44300	3.5 7.6
W-3490-A	88.900 3.5000	190.500 7.5000	50.800 2.0000	8.26 0.325	188.93 7.438	92.08 3.625	3.3 0.13	3.3 0.13	169.4 6.67	105.7 4.16	2450 551000	250 56500	7.1 15.6
N-3568-A	101.600 4.0000	247.650 9.7500	66.675 2.6250	12.70 0.500	247.65 9.750	101.60 4.000	3.6 0.14	3.6 0.14	222.0 8.74	120.7 4.75	5130 1153000	390 87800	18.0 39.0
120TTVF85 00487	120.000 4.7244	300.000 11.8110	79.000 3.1103	16.51 0.650	298.50 11.752	125.00 4.921	4.0 0.16	4.0 0.16	270.7 10.66	148.5 5.85	7310 1640000	620 140000	31.8 70.0
T4920	124.993 4.9210	185.738 7.3125	25.400 1.0000	6.60 0.260	185.74 7.313	124.99 4.921	1.5 0.06	2.0 0.08	172.9 6.81	135.1 5.32	1250 282000	90 21000	2.4 5.2
N-3586-A	126.962 4.9985	279.400 11.0000	58.738 2.3125	11.43 0.450	279.40 11.000	133.35 5.250	5.6 0.22	5.6 0.22	255.3 10.05	146.1 5.75	7020 1580000	520 117000	18.4 40.6
W-3217-B	127.000 5.0000	266.700 10.5000	58.738 2.3125	12.70 0.500	265.94 10.470	127.51 5.020	3.6 0.14	3.6 0.14	240.3 9.46	143.4 5.65	4780 1080000	400 89000	16.9 37.3
D-3461-C	127.000 5.0000	266.700 10.5000	58.738 2.3125	12.70 0.500	265.94 10.470	127.51 5.020	3.5 0.14	3.5 0.14	240.5 9.47	148.5 5.85	4780 1080000	400 89000	17.0 37.4
T660V	168.275 6.6250	304.800 12.0000	69.850 2.7500	21.92 0.863	304.80 12.000	168.28 6.625	6.4 0.25	6.4 0.25	274.0 10.79	180.9 7.12	6510 1460000	490 111000	23.7 52.2
G-3304-B	168.275 6.6250	304.800 12.0000	69.850 2.7500	14.29 0.562	303.21 11.938	171.45 6.750	6.4 0.25	6.4 0.25	277.8 10.94	188.9 7.44	7170 1610000	580 130000	25.90 57.00
S-4059-B	174.625 6.8750	358.775 14.1250	82.550 3.2500	17.48 0.688	358.78 14.125	176.21 6.938	4.8 0.19	4.8 0.19	325.4 12.81	203.2 8.00	5570 1252000	2660 597000	48.0 105.0
W-3218-B	177.800 7.0000	368.300 14.5000	82.169 3.2350	17.46 0.688	366.71 14.438	180.98 7.125	6.1 0.24	6.1 0.24	336.6 13.25	203.2 8.00	11900 2670000	880 198000	48.6 107.1
C-8435-A	177.800 7.0000	368.300 14.5000	82.550 3.2500	17.45 0.688	366.67 14.436	180.98 7.125	7.9 0.31	7.9 0.31	366.5 13.25	203.2 8.00	11900 2670000	880 198000	49.0 109.0
G-3353-B	177.800 7.0000	368.300 14.5000	82.550 3.2500	17.48 0.688	364.75 14.360	180.98 7.125	6.1 0.24	6.1 0.24	336.6 13.25	203.2 8.00	11250 2530000	760 171000	49.0 109.0
N-3559-A	177.800 7.0000	412.750 16.2500	111.125 4.3750	19.05 0.750	419.10 16.500	190.50 7.500	14.7 0.58	7.6 0.30	374.7 14.75	215.9 8.50	13000 2920000	1060 237000	91.6 202.0
B-8809-C	200.000 7.8745	405.643 15.9700	111.125 4.3750	25.40 1.000	396.85 15.624	203.20 8.000	4.0 0.16	4.0 0.16	360.0 14.17	228.6 9.00	13000 2920000	1060 237000	78.0 155.7
N-3553-A	203.200 8.0000	419.100 16.5000	92.075 3.6250	15.88 0.625	419.10 16.500	203.20 8.000	11.2 0.44	11.2 0.44	379.7 14.95	231.9 9.13	13700 3070000	1070 241000	62.0 137.0

⁽¹⁾Maximum shaft or housing fillet radius that bearing corners will clear.

⁽²⁾Bearing includes special features; contact your Timken engineer for details.

Continued on next page.

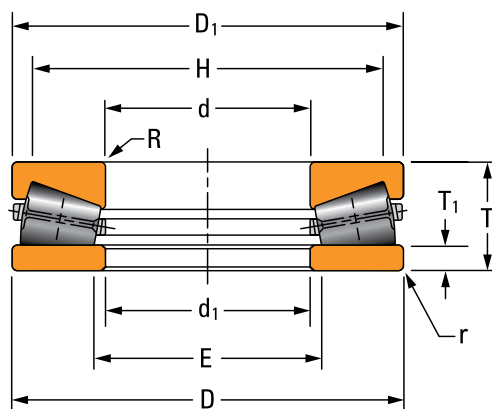

Continued from previous page.

Bearing Number	Bearing Dimensions			Rings			Fillet Radius ⁽¹⁾		Shoulder Diameter		Load Rating		Bearing Weight
	Bore	O.D.	Width	Thickness	Small Diameter O.D.	Large Bore I.D.	Shaft (Max.)	Housing (Max.)	Shaft (Min.)	Housing (Max.)	Static Load Rating	Dynamic Load Rating	
	d	D	T	T ₁	D ₁	d ₁	R	r	H	E	C _{a0}	C _{a90}	
	mm in.	mm in.	mm in.	mm in.	mm in.	mm in.	mm in.	mm in.	mm in.	mm in.	kN lbf.	kN lbf.	kg lbs.
T-6240-A	228.600 9.0000	482.600 19.0000	104.775 4.1250	22.61 0.890	482.60 19.000	228.60 9.000	4.1 0.16	11.2 0.44	449.3 17.69	255.3 10.05	20400 4590000	1430 320000	93.0 205.0
V-463-A	234.950 9.2500	546.100 21.5000	152.400 6.0000	25.40 1.000	546.10 21.500	244.48 9.625	14.7 0.58	9.1 0.36	492.5 19.39	271.3 10.68	30900 6950000	2310 519000	200.5 442.0
N-3506-A	241.300 9.5000	552.450 21.7500	139.700 5.5000	25.40 1.000	549.28 21.625	246.08 9.688	7.6 0.30	7.6 0.30	502.9 19.80	279.4 11.00	31100 6990000	2220 499000	186.0 410.0
N-3560-A	241.300 9.5000	584.200 23.0000	152.400 6.0000	31.75 1.250	581.03 22.875	246.08 9.688	7.6 0.30	7.6 0.30	526.0 20.71	279.4 11.00	33700 7580000	2450 551000	284.8 480.5
I-2077-C	253.975 9.9990	508.000 20.0000	95.250 3.7500	19.05 0.750	507.19 19.968	256.38 10.094	6.4 0.25	6.4 0.25	468.3 18.44	282.6 11.12	19600 4400000	1370 307000	110.20 243.00
C-8326-A	254.000 10.0000	508.000 20.0000	107.950 4.2500	21.44 0.844	506.43 19.938	257.18 10.125	4.8 0.19	4.8 0.19	466.9 18.38	287.0 11.30	22500 5050000	1590 358000	105.6 232.9
C-8184-A	254.000 10.0000	546.100 21.5000	127.000 5.0000	25.40 1.000	544.53 21.438	257.18 10.125	4.8 0.19	4.8 0.19	504.4 19.86	288.9 11.38	28300 6370000	2030 457000	152.9 337.0
T10100V	256.540 10.1000	546.100 21.5000	164.719 6.4850	38.22 1.505	542.93 21.375	256.54 10.100	1.5 0.06	6.4 0.25	485.1 19.10	299.5 11.79	28300 6370000	2070 465000	203.5 448.6
G-3224-C	256.540 10.1000	546.100 21.5000	165.100 6.5000	34.92 1.375	542.92 21.375	258.76 10.188	6.1 0.24	6.1 0.24	515.9 20.31	301.6 11.88	28400 6390000	2290 515000	227.20 501.00
G-3291-C	256.540 10.1000	546.100 21.5000	165.100 6.5000	34.93 1.375	542.93 21.375	258.78 10.188	7.9 0.31	7.9 0.31	485.0 19.09	301.6 11.88	28400 6390000	2290 515000	212.3 479.0
S-4077-C	259.999 10.2362	479.948 18.8956	132.080 5.2000	26.99 1.062	478.36 18.833	263.17 10.361	4.8 0.19	4.8 0.19	427 16.81	300 11.81	16500 3710000	1390 312000	126.50 279.00
N-3580-A	273.050 10.7500	609.600 24.0000	161.925 6.3750	31.75 1.250	609.60 24.000	292.10 11.500	6.4 0.25	6.4 0.25	556.0 21.89	316.7 12.47	35000 7880000	2630 591000	252.0 541.3
T11000	279.400 11.0000	603.250 23.7500	136.525 5.3750	38.10 1.500	601.70 23.689	282.58 11.125	1.5 0.06	11.2 0.44	543.5 21.40	313.8 12.35	32200 7240000	2090 469000	202.6 446.7
T11001V	279.400 11.0000	603.250 23.7500	136.525 5.3750	38.10 1.500	603.25 23.750	279.40 11.000	1.5 0.06	11.2 0.44	543.5 21.40	313.8 12.35	32200 7240000	2570 577000	203.3 448.2
T11002V	279.400 11.0000	603.250 23.7500	136.525 5.3750	38.10 1.500	603.25 23.750	279.40 11.000	1.5 0.06	11.2 0.44	543.5 21.40	313.8 12.35	32200 7240000	2570 577000	203.3 448.1
C-7964-C	279.400 11.0000	603.250 23.7500	136.525 5.3750	29.36 1.156	628.65 24.750	282.58 11.125	4.8 0.19	4.8 0.19	577.9 22.75	317.5 12.50	38700 8700000	2530 568000	230.0 506.0
C-8091-C	279.400 11.0000	603.250 23.7500	136.525 5.3750	30.16 1.188	601.66 23.688	282.58 11.125	11.2 0.44	4.8 0.19	552.4 21.75	317.5 12.50	33300 7500000	2270 511000	202.7 446.9

⁽¹⁾Maximum shaft or housing fillet radius that bearing corners will clear.

⁽²⁾Bearing includes special features; contact your Timken engineer for details.

Continued on next page.

THRUST BEARING DATA

THRUST TAPERED ROLLER BEARINGS – TYPE TTHDFL

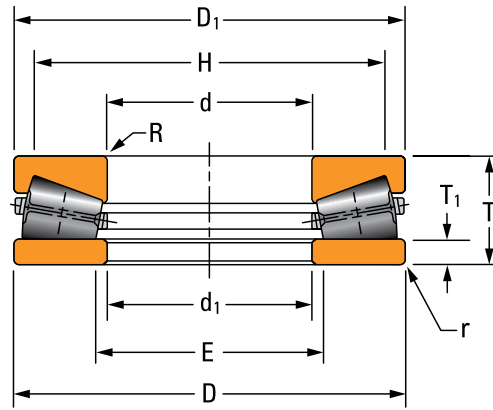

TABLE 45. THRUST TAPERED ROLLER BEARINGS – TYPE TTHDFL – continued

Bearing Number	Bearing Dimensions			Rings			Fillet Radius ⁽¹⁾		Shoulder Diameter		Load Rating		Bearing Weight
	Bore	O.D.	Width	Thickness	Small Diameter O.D.	Large Bore I.D.	Shaft (Max.)	Housing (Max.)	Shaft (Min.)	Housing (Max.)	Static Load Rating	Dynamic Load Rating	
	d	D	T	T ₁	D ₁	d ₁	R	r	H	E	C _{a0}	C _{a90}	
	mm in.	mm in.	mm in.	mm in.	mm in.	mm in.	mm in.	mm in.	mm in.	mm in.	kN lbf.	kN lbf.	kg lbs.
I-2290-C	279.400 11.0000	603.250 23.7500	136.525 5.3750	25.40 1.000	601.68 23.688	282.58 11.125	6.1 0.24	6.1 0.24	549.3 21.63	321.5 12.66	35300 7940000	2530 570000	232.0 511.0
T11500	292.100 11.5000	660.400 26.0000	127.000 5.0000	23.50 0.925	660.40 26.000	292.10 11.500	1.5 0.06	7.9 0.31	597.0 23.50	323.9 12.75	44000 9880000	2890 650000	235.2 518.4
N-3311-A	292.100 11.5000	660.400 26.0000	127.000 5.0000	19.29 0.759	673.10 26.500	295.28 11.625	9.5 0.38	9.5 0.38	644.8 25.38	334.4 13.17	45700 10300000	3030 682000	343.0 755.0
G-3272-C	304.775 11.9990	609.600 24.0000	114.046 4.4900	28.58 1.125	606.81 23.890	307.18 12.094	6.4 0.25	6.4 0.25	565.2 22.25	342.9 13.50	33100 7430000	2060 464000	180.0 396.6
E-1994-C	304.800 12.0000	673.100 26.5000	171.450 6.7500	37.31 1.469	671.51 26.438	307.98 12.125	7.6 0.30	7.6 0.30	609.3 23.99	333.1 13.11	41700 9370000	3060 687000	311.1 685.9
F-3090-A	304.800 12.0000	736.600 29.0000	279.400 11.0000	44.45 1.750	735.01 28.938	307.98 12.125	9.1 0.36	9.1 0.36	602.4 23.72	385.8 15.19	46400 10400000	4000 900000	629.2 1387.2
I-2060-C	368.541 14.5095	609.156 23.9825	120.269 4.7350	25.40 1.000	604.84 23.812	371.48 14.625	11.2 0.44	11.2 0.44	565.2 22.25	401.6 15.81	22400 5040000	1640 369000	160.6 354.0
T15500	393.700 15.5000	495.300 19.5000	44.450 1.7500	11.15 0.439	495.30 19.500	393.70 15.500	3.3 0.13	3.3 0.13	471.6 18.57	408.3 16.07	6900 1550000	370 83700	20.2 44.5
T15501	393.700 15.5000	495.300 19.5000	44.450 1.7500	11.15 0.439	495.30 19.500	393.70 15.500	3.3 0.13	3.3 0.13	471.6 18.57	408.3 16.07	6900 1550000	370 83700	18.1 40.0
F-3131-G	431.800 17.0000	863.600 34.0000	228.600 9.0000	44.45 1.750	862.01 33.938	434.98 17.125	10.2 0.40	10.2 0.40	783.3 30.84	489 19.25	66800 15000000	4790 1080000	659.0 1452.8
E-2054-G	440.000 17.3219	863.600 34.0000	228.600 9.0000	44.45 1.750	862.03 33.938	441.20 17.370	10.2 0.40	10.2 0.40	787.4 31.00	489.0 19.25	66800 15000000	4790 1080000	763.0 1681.0
F-2342-A	457.200 18.0000	762.000 30.0000	139.700 5.5000	25.40 1.000	760.43 29.938	460.38 18.125	5.1 0.20	5.1 0.20	713.6 28.09	508.0 20.00	43300 9740000	2870 645000	262.0 578.0
T18500	469.900 18.5000	917.575 36.1250	222.250 8.7500	44.45 1.750	917.58 36.125	469.90 18.500	12.7 0.50	12.7 0.50	825.7 32.51	519.6 20.46	68200 15300000	4830 1090000	508.1 1120.1
A-6096-C	508.000 20.0000	990.600 39.0000	196.850 7.7500	67.47 2.656	990.60 39.000	508.58 20.062	12.7 0.50	12.7 0.50	927.1 36.50	563.6 22.19	77800 17500000	4420 994000	882.50 1946.00
G-3734-A	508.000 20.0000	990.600 39.0000	196.850 7.7500	67.47 2.656	990.60 39.000	509.58 20.062	15.1 0.59	15.1 0.59	927.1 36.50	563.6 22.19	77800 17500000	4420 994000	857.0 1890.0
T20750	527.050 20.7500	635.000 25.0000	44.450 1.7500	12.70 0.500	635.00 25.000	527.05 20.750	3.3 0.13	3.3 0.13	611.0 24.05	544.4 21.43	7750 1740000	360 80200	28.6 63.0
F-3093-A	558.800 22.0000	1066.800 42.0000	285.370 11.2350	57.15 2.250	1065.21 41.938	561.98 22.125	10.2 0.40	10.2 0.40	952.5 37.50	639.8 25.19	89200 20100000	6550 1470000	1335.0 2943.1

⁽¹⁾Maximum shaft or housing fillet radius that bearing corners will clear.

⁽²⁾Bearing includes special features; contact your Timken engineer for details.

Continued on next page.

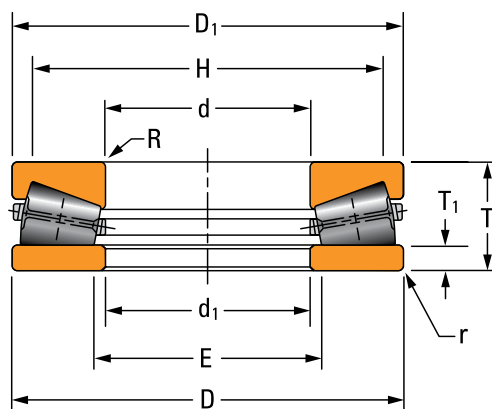

Continued from previous page.

Bearing Number	Bearing Dimensions			Rings			Fillet Radius ⁽¹⁾		Shoulder Diameter		Load Rating		Bearing Weight
	Bore	O.D.	Width	Thickness	Small Diameter O.D.	Large Bore I.D.	Shaft (Max.)	Housing (Max.)	Shaft (Min.)	Housing (Max.)	Static Load Rating	Dynamic Load Rating	
	d	D	T	T ₁	D ₁	d ₁	R	r	H	E	C _{a0}	C _{a90}	
	mm in.	mm in.	mm in.	mm in.	mm in.	mm in.	mm in.	mm in.	mm in.	mm in.	kN lbf.	kN lbf.	kg lbs.
E-2394-A ⁽²⁾	558.927 22.0050	762.000 30.0000	101.600 4.0000	27.79 1.094	762.00 30.000	559.05 22.010	6.4 0.25	3.0 0.12	736.6 29.00	587.5 23.13	22900 5150000	1310 293000	127.2 309.1
J-940-A	609.600 24.0000	812.800 32.0000	101.600 4.0000	27.79 1.094	812.80 32.000	609.60 24.000	6.4 0.25	6.4 0.25	778.5 30.65	639.3 25.17	26200 5890000	1420 319000	174.0 398.0
F-3172-C	711.200 28.0000	965.200 38.0000	127.000 5.0000	30.16 1.188	963.61 37.938	714.38 28.125	4.8 0.19	4.8 0.19	917.6 36.12	762 30.00	37300 8390000	2140 480000	354.20 781.00
H-2054-G	711.200 28.0000	990.600 39.0000	190.500 7.5000	44.45 1.750	989.01 38.938	712.79 28.062	10.2 0.40	10.2 0.40	932.0 36.69	738.7 29.08	50900 11400000	3420 770000	460.00 1013.5
E-2172-A ⁽²⁾	749.300 29.5000	952.500 37.5000	127.000 5.0000	31.75 1.250	955.68 37.625	762.00 30.000	5.1 0.20	2.5 0.10	916.0 36.06	781.2 30.75	24800 5570000	1460 328000	285.0 629.0
T30620	777.697 30.6180	889.000 35.0000	47.625 1.8750	14.26 0.562	889.00 35.000	777.70 30.618	3.3 0.13	3.3 0.13	863.2 33.99	796.6 31.36	11500 2580000	440 99300	44.7 98.6
E-2267-A	800.100 31.5000	1041.400 41.0000	139.700 5.5000	30.94 1.218	1041.40 41.000	800.10 31.500	6.0 0.24	4.0 0.16	999.4 39.35	849.8 33.46	40600 9120000	2440 548000	308.1 679.3
E-2421-A	850.900 33.5000	1130.300 44.5000	149.860 5.9000	33.32 1.312	1130.00 44.489	850.90 33.500	9.5 0.38	3.2 0.13	1063.6 41.88	890.6 35.06	48800 11000000	2890 650000	462.0 1018.0
T34250	870.001 34.2520	980.001 38.5827	50.000 1.9685	14.22 0.560	980.00 38.583	870.00 34.252	3.3 0.13	3.3 0.13	950.7 37.43	898.4 35.37	12500 2820000	480 109000	52.7 116.3
E-1987-C	939.800 37.0000	1244.600 49.0000	152.400 6.0000	35.71 1.406	1244.60 49.000	942.34 37.100	1.5 0.06	1.5 0.06	1193.8 47.00	984.3 38.75	65200 14600000	3440 774000	544.3 1200.0
S-4228-C	970.700 38.2165	1249.950 49.2105	130.000 5.1881	30.96 1.219	1249.95 49.211	970.70 38.217	4.8 0.19	4.8 0.19	1206.5 47.50	1012.8 39.88	59400 13400000	2900 651000	499.0 1099.0
T45750	1162.050 45.7500	1282.700 50.5000	52.388 2.0625	15.96 0.628	1282.70 50.500	1162.05 45.750	3.3 0.13	3.3 0.13	1256.2 49.45	1180.0 46.46	19000 4280000	620 139000	80.7 177.8
T45751	1162.050 45.7500	1282.700 50.5000	57.099 2.2480	20.67 0.814	1282.70 50.500	1162.05 45.750	3.3 0.13	3.3 0.13	1256.2 49.45	1180.0 46.46	19000 4280000	620 139000	80.7 177.8
T53250	1352.550 53.2500	1473.200 58.0000	52.375 2.0620	15.89 0.626	1473.20 58.000	1352.55 53.250	3.3 0.13	3.3 0.13	1444.7 56.88	1368.5 53.88	21100 4750000	650 146000	94.4 208.0

⁽¹⁾Maximum shaft or housing fillet radius that bearing corners will clear.

⁽²⁾Bearing includes special features; contact your Timken engineer for details.

TYPE TTHDFLSA

- Same basic roller and raceway design as the TTHDFL, except that the lower race is composed of two pieces whose faces are spherically ground to permit self-alignment under conditions of initial misalignment.
- TTHDFLSA bearings should not be used if dynamic misalignment (changing under load) is expected.

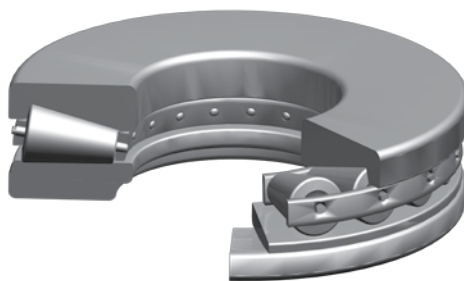
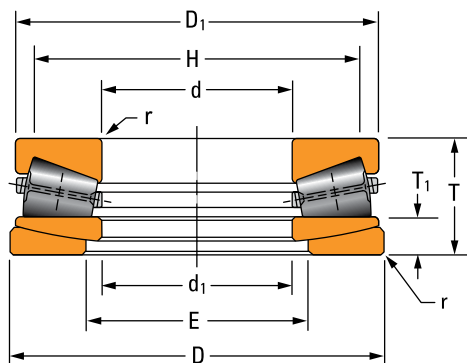

Fig. 75. Type TTHDFLSA thrust tapered roller bearing.



OVERALL DIMENSIONS:

- d – Bore diameter
- D – Bearing O.D.
- T – Bearing width
- T₁ – Ring thickness
- d₁ – Large bore I.D.
- D₁ – Small diameter O.D.
- E – Housing shoulder diameter
- H – Shaft shoulder diameter
- r – Shaft/housing maximum fillet radius

Fig. 76. Type TTHDFLSA thrust tapered roller bearing assembly.

THRUST BEARING DATA

THRUST TAPERED ROLLER BEARINGS – TYPE TTHDFLSA

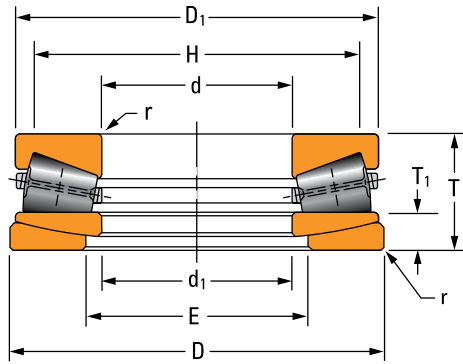

TABLE 46. THRUST TAPERED ROLLER BEARINGS – TYPE TTHDFLSA

Bearing Number	Bearing Dimensions			Rings			Fillet ⁽¹⁾ Radius (Max.) r	Shoulder Diameter		Load Rating		Bearing Weight
	Bore	O.D.	Width	Thickness	Small Diameter O.D.	Large Bore I.D.		Shaft (Min.)	Housing (Max.)	Static Load Ratings	Dynamic Load Ratings	
	d	D	T	T ₁	D ₁	d ₁		H	E	C _{a0}	C _{a90}	
	mm in.	mm in.	mm in.	mm in.	mm in.	mm in.	mm in.	mm in.	mm in.	kN lbf.	kN lbf.	kg lbs.
A-5934-B	101.600 4.0000	203.200 8.0000	47.625 1.8750	15.37 0.605	203.20 8.000	101.60 4.000	1.5 0.06	182.6 7.19	119.1 4.69	2300 517000	200 44200	(2)
C-7862-C	127.000 5.0000	266.700 10.5000	71.425 2.8120	25.40 1.000	266.70 10.500	128.59 5.063	3.6 0.14	238.2 9.38	149.4 5.88	4920 1110000	400 91200	27.0 59.0
B-7976-C	184.150 7.2500	406.400 16.0000	203.200 8.0000	66.68 2.625	404.81 15.938	187.32 7.375	6.1 0.24	346.1 13.62	228.6 9.00	15000 3380000	1370 308000	157.4 347.0
B-8824-C	199.374 7.8730	399.948 15.7460	121.841 4.7969	36.40 1.433	396.88 15.625	203.20 8.000	4.1 0.16	358.8 14.12	240.5 9.47	13000 2920000	1060 237000	82.7 182.4
S-3806-B	199.975 7.8730	399.975 15.7470	121.881 4.7985	36.40 1.433	399.98 15.747	203.20 8.000	4 0.16	360.7 14.20	240.5 9.47	13000 2920000	1060 237000	(2)
E-2004-C	228.600 9.0000	482.549 18.9980	158.750 6.2500	44.91 1.768	479.55 18.880	231.78 9.125	4.8 0.19	419.1 16.50	282.6 11.12	20000 4500000	1670 375000	170.1 375.0
H-2212-A	228.600 9.0000	482.600 19.0000	158.750 6.2500	44.91 1.768	479.55 18.880	257.18 10.125	6.4 0.25	431.8 17.00	282.6 11.13	20000 4500000	1670 375000	142.2 313.5
H-1685-C	241.300 9.5000	488.899 19.2480	152.400 6.0000	57.15 2.250	482.60 19.000	242.09 9.531	6.1 0.24	431.8 17.00	279.4 11.00	18900 4240000	1460 329000	155.9 343.7
P-1739-C	304.800 12.0000	609.600 24.0000	215.900 8.5000	61.90 2.437	608.01 23.938	307.98 12.125	9.7 0.38	536.6 21.12	349.2 13.75	31100 6990000	2610 586000	305.6 673.8
B-8750-G	355.600 14.0000	660.400 26.0000	254.000 10.0000	76.20 3.000	657.23 25.875	358.78 14.125	10.2 0.4	577.9 22.75	412.8 16.25	34200 7700000	2900 652000	(2)
B-8424-C	406.400 16.0000	869.950 34.2500	241.300 9.5000	82.55 3.250	887.41 34.938	438.15 17.250	16.5 0.65	803.3 31.62	463.6 18.25	73500 16500000	4840 1090000	858.0 1892.0
B-8073-C	508.000 20.0000	990.600 39.0000	196.850 7.7500	67.31 2.650	989.03 38.938	511.18 20.125	12.7 0.5	927.1 36.50	563.6 22.19	77800 17500000	4420 994000	(2)

⁽¹⁾Maximum shaft or housing fillet radius that bearing corners will clear.

⁽²⁾Contact your Timken engineer for details.

TYPES TTSP, TTSPS AND TTSPSPL

- Comprised of two thrust tapered races, rollers, cage and an outside retainer which holds the components together during shipping and installation.
- Off-apex roller arrangement.
- These are light-duty thrust bearings which are used extensively in the steering pivot positions of automotive and other industrial applications.
- Types TTSP, TTSPS and TTSPSPL are identical except for the cage construction.

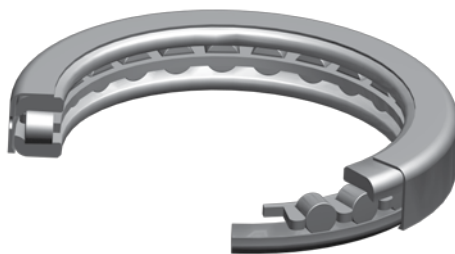
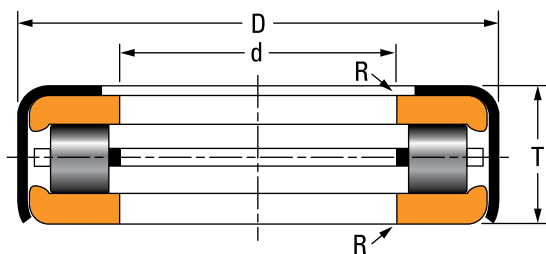

Fig. 77. Type TTSP thrust tapered roller bearing.



OVERALL DIMENSIONS:

- d – Bore diameter
- D – Bearing O.D.
- T – Bearing width
- R – Shaft maximum fillet radius

Fig. 78. Type TTSP thrust tapered roller bearing assembly.

DESIGN TYPES

TTSP

- Two tapered races.
- Stamped steel assembly retainer.
- Finger-type cage riding on small roller ends.

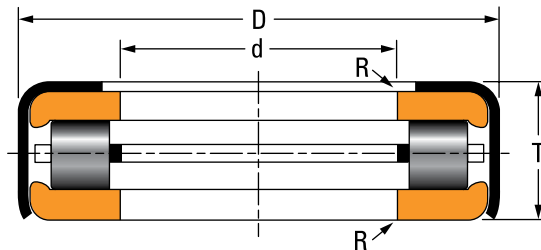

Fig. 79. Type TTSP.

TTSPS

- Two tapered races.
- Stamped steel assembly retainer.
- Finger-type cage riding on large roller ends.

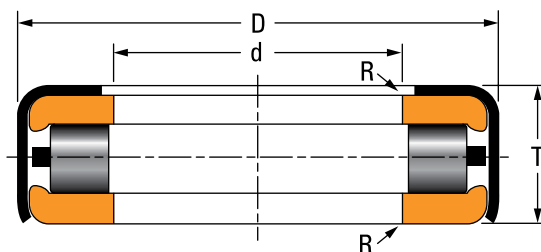

Fig. 80. Type TTSPS.

TTSPS

- Two tapered races.
- Stamped steel assembly retainer.
- Two-piece stamped steel cage.

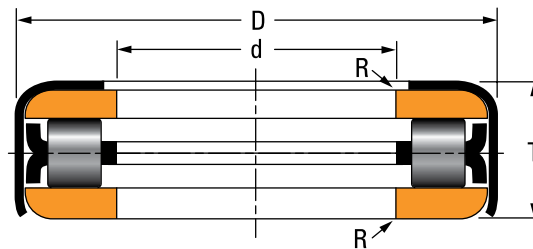

Fig. 81. Type TTSPS.

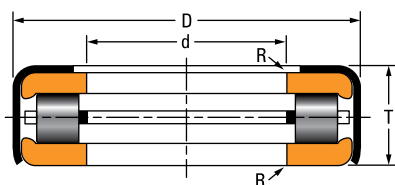

Fig. 1

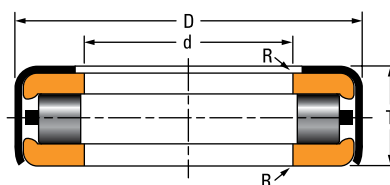

Fig. 2

TABLE 47. THRUST TAPERED ROLLER BEARINGS – TYPE TTSP

Bearing Number		Figure Number	Bearing Dimensions			Fillet ⁽¹⁾ Radius (Max.) R	Load Rating Steering Pivot Rating	Bearing Weight	Remarks
No Oil Holes In Retainer	Oil Holes In Retainer		Bore d	O.D. D	Width T				
			mm in.	mm in.	mm in.	mm in.	N lbf.	kg lbs.	
T63	T63W	1	16.129 0.6350	41.275 1.6250	12.7 0.5000	0.8 0.03	11100 2500	0.1 0.2	
T77	T77W	1	19.304 0.7600	41.275 1.6250	12.7 0.5000	0.8 0.03	11100 2500	0.1 0.2	
T76	T76W	1	19.304 0.7600	41.275 1.6250	13.487 0.5310	0.8 0.03	11100 2500	0.1 0.2	
T86		1	20.257 0.7975	39.688 1.5625	14.288 0.5625	1.3 0.05	10700 2400	0.1 0.2	
T82	T82W	1	20.879 0.8220	41.275 1.6250	13.487 0.5310	0.8 0.03	11100 2500	0.1 0.2	
T88	T88W	1	22.479 0.8850	48.021 1.8906	15.088 0.5940	0.8 0.03	17300 3890	0.1 0.2	
T89		1	22.479 0.8850	48.021 1.8906	15.875 0.6250	0.8 0.03	17350 3900	0.1 0.3	
T92		2	23.825 0.9380	44.958 1.7700	13.487 0.5310	0.8 0.03	11950 2690	(2)	T92 has two bores, other bore = 24.054 mm (0.9470 in.)
T93		2	24.054 0.9470	44.958 1.7700	13.487 0.5310	0.8 0.03	11950 2690	0.1 0.2	
T94	T94W	1	24.054 0.9470	48.021 1.8906	15.088 0.5940	0.8 0.03	17350 3900	0.1 0.2	
T95	T95W	1	24.13 0.9500	50.8 2.0000	15.875 0.6250	0.8 0.03	18600 4200	0.1 0.3	
T101	T101W	1	25.654 1.0100	50.8 2.0000	15.875 0.6250	0.8 0.03	18600 4200	0.1 0.3	
T105		1	25.654 1.0100	50.8 2.0000	15.875 0.6250	0.8 0.03	18600 4200	(2)	T105 has 2 bores, other bore = 27.299 mm (1.0720 in.)
T102–T102R		1	25.654 1.0100	50.8 2.0000	16.916 0.6660	0.8 0.03	18600 4200	(2)	T102 has extended retainer Contact Timken engineer for details
T114	T114W	1	25.654 1.0100	55.562 2.1875	15.875 0.6250	0.8 0.03	20000 4500	(2)	T114 and T114W have two bores, other bore = 28.829 mm (1.1350 in.)
T104	T104W	1	26.289 1.0350	50.8 2.0000	15.875 0.6250	0.8 0.03	18600 4200	0.1 0.3	
T107		1	27.299 1.0720	50.8 2.0000	15.875 0.6250	0.8 0.03	18600 4200	0.1 0.3	
T114X		2	28.829 1.1350	50.8 2.0000	15.875 0.6250	0.8 0.03	20000 4500	(2)	T114X has two cages and two bores, other bore = 29.261 mm (1.1520 in.)

⁽¹⁾Maximum shaft or housing fillet radius that bearing corners will clear.

⁽²⁾Contact your Timken engineer for details.

Continued on next page.

THRUST BEARING DATA

THRUST TAPERED ROLLER BEARINGS – TYPES TTSP, TTSPS AND TTSP L

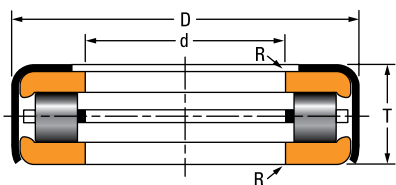

Fig. 1

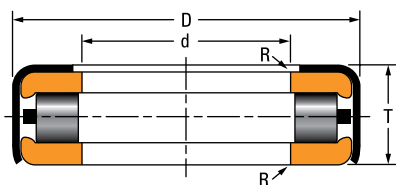

Fig. 2

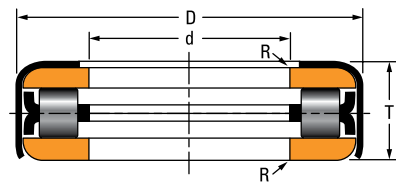

Fig. 3

TABLE 47. THRUST TAPERED ROLLER BEARINGS – TYPE TTSP – continued

Bearing Number		Figure Number	Bearing Dimensions			Fillet ⁽¹⁾ Radius (Max.) R	Load Rating Steering Pivot Rating	Bearing Weight	Remarks
No Oil Holes In Retainer	Oil Holes In Retainer		Bore d	O.D. D	Width T				
			mm in.	mm in.	mm in.	mm in.	N lbf.	kg lbs.	
T110	T110W	1	28.829 1.1350	53.188 2.0940	15.875 0.6250	0.8 0.03	20000 4500	0.1 0.3	
T113	T113W	1	28.829 1.1350	55.562 2.1875	15.875 0.6250	0.8 0.03	20000 4500	0.2 0.3	
T113X		1	28.829 1.1350	55.562 2.1875	15.875 0.6250	0.8 0.03	20000 4500	0.2 0.4	
T120		2	30.416 1.1975	54.745 2.1553	11.43 0.4500	0.8 0.03	16500 3710	0.1 0.2	
T119	T119W	1	30.416 1.1975	55.562 2.1875	15.875 0.6250	0.8 0.03	20000 4500	0.2 0.3	
T121		1	30.716 1.2093	55.562 2.1875	15.875 0.6250	0.8 0.03	20000 4500	0.2 0.4	
T126	T126W	1	32.004 1.2600	55.562 2.1875	15.875 0.6250	0.8 0.03	20000 4500	0.1 0.3	
T126A	T126AW	1	32.004 1.2600	55.562 2.1875	15.875 0.6250	0.8 0.03	20000 4500	0.1 0.3	T126A – two cages
T1370		1	35.02 1.3787	55.562 2.1875	15.875 0.6250	0.8 0.3	16000 3600	0.1 0.3	
T139	T139W	1	35.179 1.3850	58.738 2.3125	15.875 0.6250	0.8 0.03	21400 4800	0.2 0.3	
T142	T142W	1	35.179 1.3850	62.708 2.4688	19.431 0.7650	0.8 0.03	22400 5050	0.2 0.5	
T149	T149W	1	38.303 1.5080	65.883 2.5938	19.431 0.7650	0.8 0.03	23600 5300	0.2 0.5	
T158		1	40.234 1.5840	65.883 2.5938	19.431 0.7650	0.8 0.03	23600 5300	0.2 0.5	
T1760		3	44.623 1.7568	76.2 3.0000	10.922 0.4300	0.8 0.03	31600 7100	0.2 0.4	
T199	T199W	1	51.054 2.0100	74.612 2.9375	15.875 0.6250	0.8 0.03	26000 5850	0.2 0.4	
T309		1	78.583 3.0938	102.395 4.0313	15.875 0.6250	0.8 0.03	35400 8000	0.3 0.6	
T387	T387W	1	96.425 3.8750	127 5.0000	17.463 0.7650	0.8 0.03	43000 9700	0.5 1.1	
T484		1	123.012 4.8430	152.4 6.0000	17.463 0.6875	0.8 0.03	47500 10600	0.6 1.4	
T581		1	147.638 5.8125	177.8 7.0000	17.463 0.6875	0.8 0.03	51500 11600	0.9 2.0	

⁽¹⁾Maximum shaft or housing fillet radius that bearing corners will clear.

⁽²⁾Contact your Timken engineer for details.

TYPES TTC, TTCS AND TTCL

- Comprised of two thrust tapered races, rollers and an outside retainer which holds the components together during shipping and installation.
- Full complement design (cageless).
- These thrust bearings are specifically designed for oscillating applications.
- Types TTC, TTCS and TTCL are identical except for the outside retainer construction.



Fig. 82. Type TTC thrust tapered roller bearing.

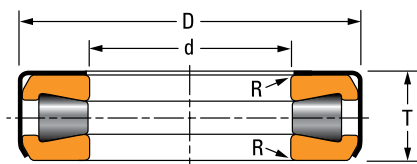

Fig. 83. Type TTC thrust tapered roller bearing assembly.

OVERALL DIMENSIONS:

- d – Bore diameter
- D – Bearing O.D.
- T – Bearing width
- R – Shaft maximum fillet radius

DESIGN TYPES

TTC

- Two tapered races.
- Full complement of rollers, no cage.
- Stamped-steel assembly retainer that fully wraps around one race.

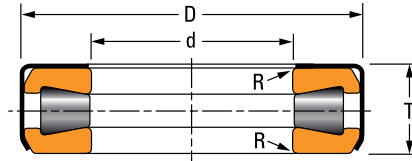

Fig. 84. Type TTC.

TTCS

- Two tapered races.
- Full complement of rollers, no cage.
- Stamped steel assembly retainer pressed onto the O.D. faces.

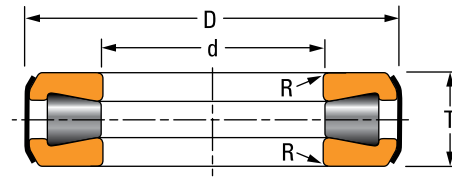

Fig. 85. Type TTCS.

TTCL

- Two tapered races.
- Full complement of rollers, no cage.
- Two-piece stamped steel retainer with O.D. seal.

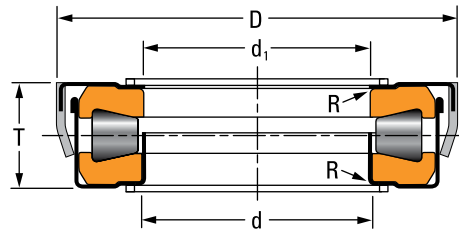

Fig. 86. Type TTCL.

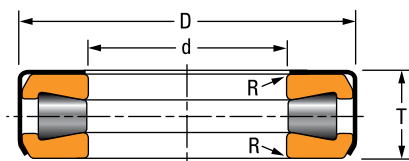

Fig. 1

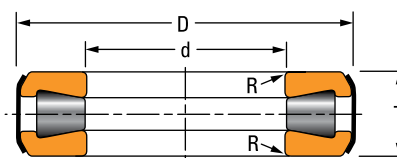

Fig. 2

TABLE 48. THRUST TAPERED ROLLER BEARINGS – TYPE TTC, TTCS AND TTCL

Bearing Number		Figure Number	Bearing Dimensions			Fillet ⁽¹⁾ Radius (Max.) R	Load Rating Steering Pivot Rating	Bearing Weight	Remarks
No Oil Holes In Retainer	Oil Holes In Retainer		Bore d	O.D. D	Width T				
mm in.	mm in.		mm in.	mm in.	mm in.	N lbf.	kg lbs.		
T130		1	27.102 1.0670	66.675 2.6250	19.446 0.7656	0.8 0.03	42200 9450	0.3 0.8	
T1260	T1260W	1	32.004 1.2600	55.562 2.1875	15.875 0.6250	0.8 0.03	27600 6200	0.2 0.4	
T128		2	32.004 1.2600	66.675 2.6250	18.654 0.7344	0.8 0.03	42200 9450	0.3 0.6	
T127	T127W	1	32.004 1.2600	66.675 2.6250	19.446 0.7656	0.8 0.03	42200 9450	0.3 0.7	
T1380		SPCL ⁽²⁾	35.179 1.3850	59.400 2.3386	15.875 0.6250	0.8 0.03	31200 7000	0.4 0.8	Two-piece seal.
T136		2	35.179 1.3850	66.675 2.6250	18.654 0.7344	0.8 0.03	42200 9450	0.3 0.6	
T138	T138W	1	35.179 1.3850	66.675 2.6250	19.446 0.7656	0.8 0.03	42200 9450	0.3 0.7	
T138XS		SPCL ⁽²⁾	35.179 1.3850	66.675 2.6250	19.446 0.7656	0.8 0.03	42200 9450	0.3 0.7	T138XS has two bores, other bore = 35.387 mm (1.3972 in.).
T1381		2	35.180 1.3850	59.475 2.3415	15.875 0.6250	0.8 0.03	31200 7000	0.3 0.7	
T144	T144W	1	36.754 1.4470	66.675 2.6250	19.446 0.7656	1.5 0.06	42200 9450	0.3 0.6	
T144XA		SPCL ⁽²⁾	36.754 1.4470	66.675 2.6250	19.446 0.7656	1.5 0.06	42200 9450	0.3 0.6	T144XA has two bores, other bore = 37.137 mm (1.4621 in.).
T152		2	38.354 1.5100	72.619 2.8590	20.638 0.8125	0.8 0.03	47000 10600	0.4 0.8	
T151	T151W	1	38.354 1.5100	72.619 2.8590	21.433 0.8438	0.8 0.03	47000 10600	0.4 0.8	
T157	T157W	1	39.954 1.5730	72.619 2.8590	21.433 0.8438	0.8 0.03	47000 10600	0.4 0.8	
T178		1	40.401 1.5906	73.000 2.8740	19.000 0.7480	0.8 0.03	47500 10700	0.3 0.7	
T163	T163W	1	41.529 1.6350	72.619 2.8590	21.433 0.8438	0.8 0.03	47000 10600	0.4 0.8	
T163X	T163XW	1	41.529 1.6350	72.619 2.8590	21.433 0.8438	2 0.80	47000 10600	0.4 0.8	
T169	T169W	1	43.104 1.6970	82.956 3.2660	23.812 0.9375	0.8 0.03	64000 14300	0.6 1.2	

⁽¹⁾Maximum shaft fillet radius that bearing corners will clear.

⁽²⁾SPCL = special not shown.

Continued on next page.

THRUST BEARING DATA

THRUST TAPERED ROLLER BEARINGS – TYPES TTC, TTCS AND TTCL

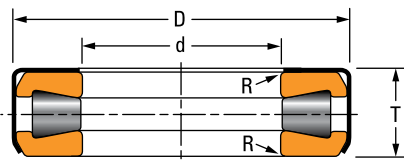

Fig. 1

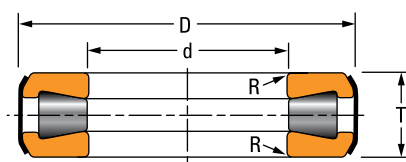

Fig. 2

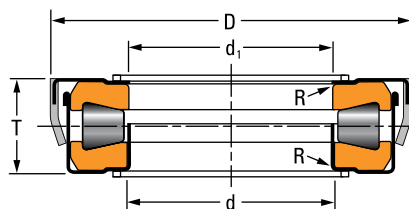

Fig. 3

TABLE 48. THRUST TAPERED ROLLER BEARINGS – TYPE TTC, TTCS AND TTCL – continued

Bearing Number		Figure Number	Bearing Dimensions			Fillet ⁽¹⁾ Radius (Max.) R	Load Rating Steering Pivot Rating	Bearing Weight	Remarks
No Oil Holes In Retainer	Oil Holes In Retainer		Bore d	O.D. D	Width T				
mm in.	mm in.		mm in.	mm in.	mm in.	N lbf.	kg lbs.		
T176	T176W	1	44.704 1.7600	82.956 3.2660	23.812 0.9375	0.8 0.03	64000 14300	0.5 1.2	
T177		1	45.000 1.7717	73.000 2.8740	20.000 0.7874	0.8 0.03	47500 10700	0.3 0.7	
T177XA		SPCL ⁽²⁾	45.000 1.7717	73.127 2.8790	20.000 0.7874	0.8 0.03	47500 10700	0.3 0.7	T177XA has two bores, other bore = 45.484 mm (1.7907 in.).
T177S		3	45.000 1.7717	74.500 2.9331	20.221 0.7961	0.8 0.03	47500 10700	0.4 0.8	
T177A		1	45.484 1.7907	73.000 2.8740	20.000 0.7874	0.8 0.03	47500 10700	0.3 0.7	
T1921		1	46.279 1.8220	80.010 3.1500	15.977 0.6290	0.8 0.03	56500 12700	0.3 0.8	
T182	T182W	1	46.279 1.8220	82.956 3.2660	23.812 0.9375	0.8 0.03	64000 14300	0.5 1.2	
T189	T189W	2	47.879 1.8850	82.956 3.2660	23.020 0.9063	0.8 0.03	64000 14300	0.5 1.1	
T188	T188W	1	47.879 1.8850	82.956 3.2660	23.812 0.9375	0.8 0.03	64000 14300	0.5 1.2	
T190		2	47.879 1.8850	83.083 3.2710	23.020 0.9063	0.8 0.03	64000 14300	0.5 1.2	
T1910		3	49.000 1.9290	85.471 3.3650	16.383 0.6450	0.8 0.03	56500 12700	0.3 0.7	
T1920		3	49.000 1.9290	85.471 3.3650	16.383 0.6450	0.8 0.03	56500 12700	0.4 0.8	
T1930		3	49.000 1.9290	85.471 3.3650	16.383 0.6450	0.8 0.03	56500 12700	0.3 0.6	
T193	T193W	2	49.454 1.9470	93.269 3.6720	26.187 1.0310	0.8 0.03	86000 19400	0.8 1.8	
T194	T194W	1	49.454 1.9470	93.269 3.6720	26.975 1.0620	0.8 0.03	86000 19400	0.8 1.8	
T195		2	49.467 1.9475	93.396 3.6770	26.213 1.0320	0.8 0.03	86000 19400	0.9 1.9	
T201	T201W	2	51.054 2.0100	93.269 3.6720	26.187 1.0310	3.3 0.13	86000 19400	0.8 1.7	
T202	T202W	1	51.054 2.0100	93.269 3.6720	26.975 1.0620	3.3 0.13	86000 19400	0.8 1.8	
T209	T209W	2	52.629 2.0720	93.269 3.6720	26.187 1.0310	0.8 0.03	86000 19400	0.8 1.7	

⁽¹⁾Maximum shaft fillet radius that bearing corners will clear.

⁽²⁾SPCL = special not shown.

Continued on next page.

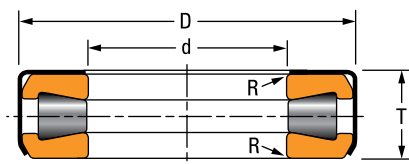

Fig. 1

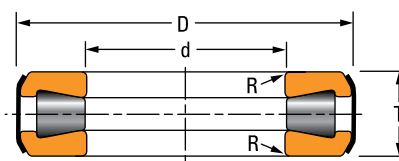

Fig. 2

Continued from previous page.

Bearing Number		Figure Number	Bearing Dimensions			Fillet ⁽¹⁾ Radius (Max.) R	Load Rating		Remarks
No Oil Holes In Retainer	Oil Holes In Retainer		Bore d	O.D. D	Width T		Steering Pivot Rating	Bearing Weight	
mm in.	mm in.		mm in.	mm in.	mm in.		N lbf.	kg lbs.	
T208	T208W	1	52.629 2.0720	93.269 3.6720	26.975 1.0620	0.8 0.03	86000 19400	0.8 1.7	
T252	T252W	2	63.754 2.5100	111.125 4.3750	25.796 1.0156	0.8 0.03	124000 27900	1.1 2.2	
T251	T251W	1	63.754 2.5100	111.125 4.3750	26.988 1.0625	0.8 0.03	124000 27900	1.1 2.4	
T301	T301W	2	76.454 3.0100	133.350 5.2500	33.338 1.3125	2.3 0.09	178500 40000	1.9 4.1	
T302	T302W	1	76.454 3.0100	133.350 5.2500	34.925 1.3750	2.3 0.09	178500 40000	2.0 4.4	
T350		2	88.900 3.5000	133.350 5.2500	33.335 1.3124	2.8 0.11	115500 26000	1.4 3.1	
T4020		2	102.108 4.0200	179.619 7.0716	31.750 1.2500	1.5 0.06	324000 73000	3.7 8.2	
T402	T402W	2	102.108 4.0200	179.619 7.0716	44.450 1.7500	1.5 0.06	344000 77500	4.8 10.7	
T600	T600W	1	152.400 8.0000	241.300 9.5000	76.200 3.0000	3.3 0.13	575000 129000	14.1 31.1	

⁽¹⁾Maximum shaft fillet radius that bearing corners will clear.

⁽²⁾SPCL = special not shown.

SCREWDOWN BEARINGS – TYPES TTHDSX/SV AND TTHDFLSX/SV

- Designed specifically for rolling mill screw-down systems in the metals industry.
- Full complement (cageless) designs.
- Design variants include bearings with either a convex or concave profile tapered race.

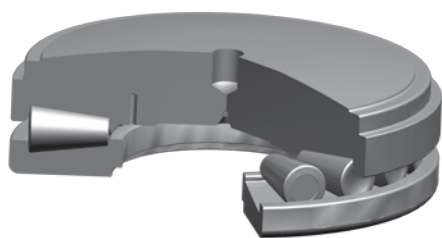

Fig. 87. Type TTHDSX.

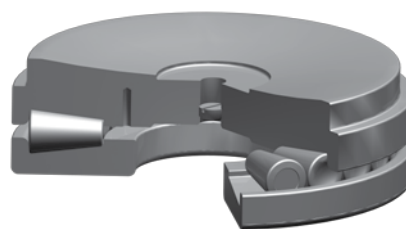

Fig. 88. Type TTHDSV.

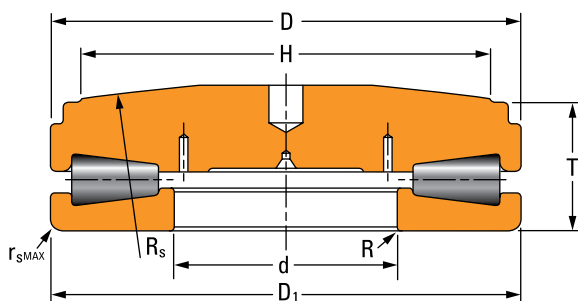

Fig. 89. Type TTHDSX thrust tapered roller bearing assembly.

OVERALL DIMENSIONS:

- d – Bore diameter (applies to TTHDSX and TTHDSV)
- D – Large O.D.
- D₁ – Small O.D.
- T – Bearing width
- H – Screw extension diameter
- R_s – Spherical radius
- R – Shaft maximum fillet radius
- r_{s max} – Housing maximum fillet radius

DESIGN TYPES

TTHDFLSX-1

- One lower flat race.
- One upper tapered race with a special convex profile.

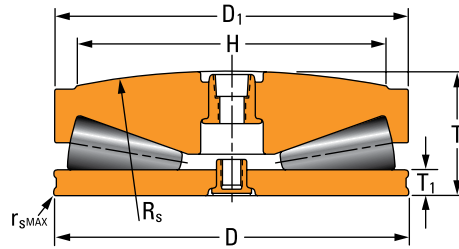

Fig. 90. Type TTHDFLSX-1.

TTHDFLSX-2

- One lower flat race.
- One upper tapered race with a special convex profile.
- Cage.

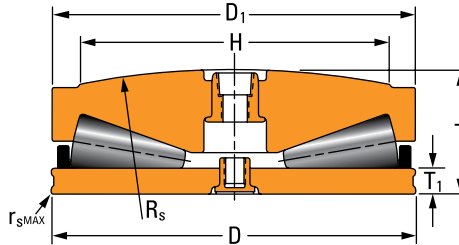

Fig. 91. Type TTHDFLSX-2.

TTHDFLSX-3

- Three-ring design.
- One lower flat race.
- One upper tapered race with a special convex profile.
- One top aligning plate.

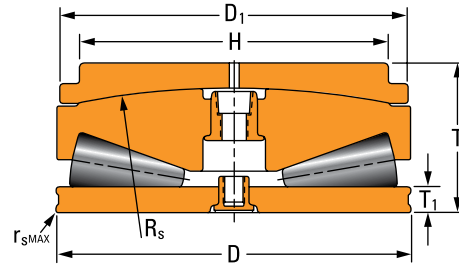

Fig. 92. Type TTHDFLSX-3.

TTHDSX-1

- One lower tapered race with axial bore.
- One upper tapered race with a special convex profile.

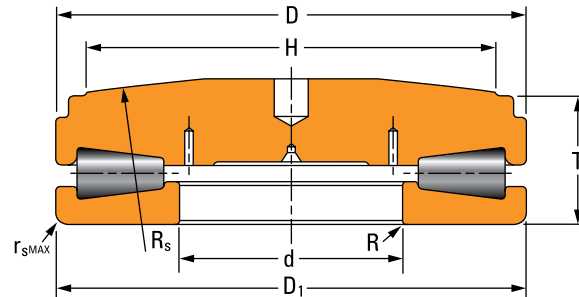

Fig. 93. Type TTHDSX-1.

TTHDSX-2

- One lower tapered race with axial bore and recess diameter.
- One upper tapered race with a special convex profile.

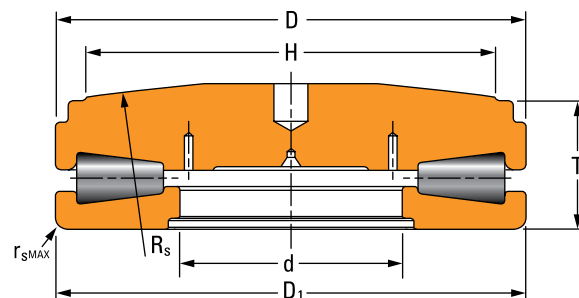

Fig. 94. Type TTHDSX-2.

TTHDFLSV-1

- One lower flat race.
- One upper tapered race with a special concave profile.

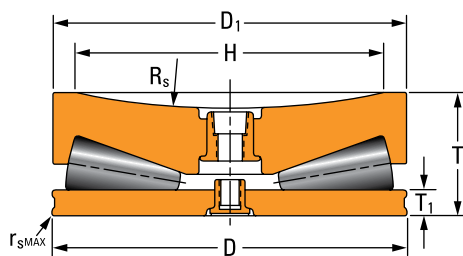

Fig. 95. Type TTHDFLSV-1.

TTHDFLSV-2

- Three-ring design.
- One lower flat race with a special convex profile.
- One upper tapered race.
- One bottom aligning plate.

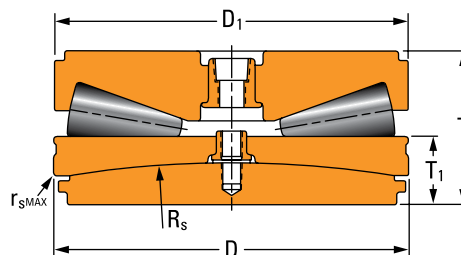

Fig. 96. Type TTHDFLSV-2.

TTHDSV-1

- One lower tapered race with axial bore.
- One upper tapered race with a special concave profile.

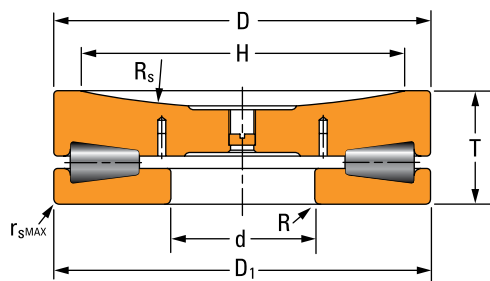

Fig. 97. Type TTHDSV-1.

TTHDSV-2

- One lower tapered race with axial bore and recess diameter.
- One upper tapered race with a special concave profile.

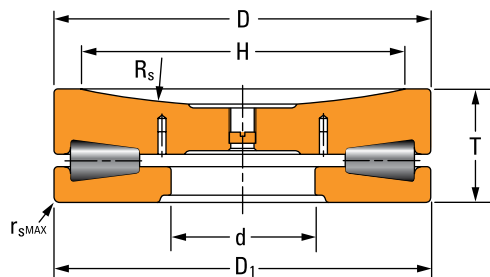

Fig. 98. Type TTHDSV-2.

TTHDDV

- One lower flat race.
- One upper tapered race.

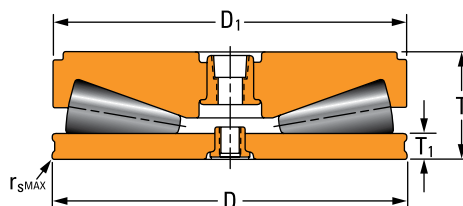

Fig. 99. Type TTHDDV.

THRUST BEARING DATA

THRUST TAPERED ROLLER BEARINGS – SCREWDOWN BEARINGS – TYPES TTHDSX/SV AND TTHDFLSX/SV

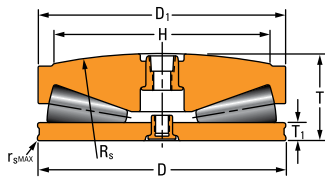

Fig. 1

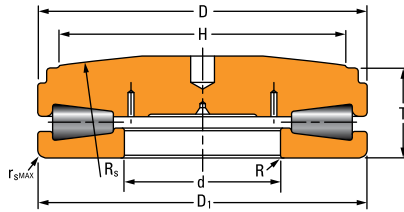

Fig. 3

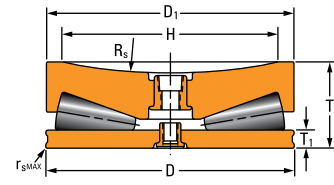

Fig. 7

TABLE 49. SCREWDOWN BEARINGS – TYPES TTHDSX/SV AND TTHDFLSX/SV

Bearing Part Number	Figure No.	Bearing Dimensions						Static Load Rating C_{a0}	Mounting Dimensions			Bearing Weight kg lbs.	Tolerance Table
		Large O.D.	Small O.D.	Bearing Width	Flat Race Width	Bore	Screw Extension Diameter		Spherical Radius				
		D	D ₁	T	T ₁	d	H		R _s	r _{s max}	R		
		mm in.	mm in.	mm in.	mm in.	mm in.	mm in.	mm in.	mm in.	mm in.	kg lbs.		
B-7461-B	1	123.825 4.8750	120.650 4.7500	43.332 1.7060	38.100 1.5000	–	101.600 4.0000	1500 337000	457.2 18.00	1.5 0.06	–	(1)	10, 11
58 TTSV 908	7	149.225 5.8750	146.863 5.7820	47.625 1.8750	12.700 0.5000	–	127.000 5.0000	2520 566000	228.6 9.00	1.5 0.06	–	(1)	10, 11
T311-T311S	3	161.925 6.3750	161.925 6.3750	49.213 1.9375	–	76.200 3.0000	127.000 5.0000	2330 524000	457.2 18.00	3.3 0.13	3.3 0.13	6.6 14.5	9, 10, 11
68 TTSV 910	7	174.625 6.8750	172.263 6.7820	52.375 2.0620	12.700 0.5000	–	152.400 6.0000	3180 716000	228.6 9.00	1.6 0.06	–	(1)	10, 11
68 TTSX 910	1	174.625 6.8750	172.263 6.7820	61.392 2.4170	12.700 0.5000	–	152.400 6.0000	3180 716000	457.2 18.00	1.5 0.06	–	(1)	10, 11
80 TTSX 914	1	203.200 8.0000	200.838 7.9070	75.616 2.9770	15.875 0.6250	–	177.800 7.0000	4630 1040000	508.0 20.00	1.6 0.06	–	17.7 38.9	10, 11
80 TTSX 914 OA076	1	203.200 8.0000	200.838 7.9070	95.250 3.7500	15.875 0.6250	–	177.800 7.0000	4630 1040000	508.0 20.00	1.5 0.06	–	(1)	10, 11
T411FAS-T411S	3	215.900 8.5000	215.900 8.5000	65.088 2.5625	–	76.200 3.0000	171.450 6.7500	4020 904000	508.0 20.00	3.3 0.13	3.3 0.13	8.9 19.6	9, 10, 11
105 TTSV 918	7	266.700 10.5000	264.338 10.4070	80.963 3.1875	19.050 0.7500	–	228.600 9.0000	8230 1850000	304.8 12.00	1.5 0.06	–	32.6 71.8	Spec.
105 TTSV 918 OC1150	7	266.700 10.5000	264.338 10.4070	80.950 3.1870	19.050 0.7500	–	228.600 9.0000	8230 1850000	355.6 14.00	1.5 0.06	–	30.0 66.0	10, 11
105 TTSX 918 B0035	1	266.700 10.5000	264.338 10.4070	94.412 3.7170	19.050 0.7500	–	228.600 9.0000	8230 1850000	609.6 24.00	1.5 0.06	–	38.0 83.8	10, 11
T511FSA-T511S	3	266.700 10.5000	266.700 10.5000	79.375 3.1250	–	101.600 4.0000	215.900 8.5000	6050 1360000	609.6 24.00	4.8 0.19	4.8 0.19	17.8 39.2	9, 10, 11
T511FS-T511SB	3	266.700 10.5000	266.700 10.5000	79.375 3.1250	–	112.700 4.4370	215.900 8.5000	6050 1360000	609.6 24.00	4.8 0.19	4.8 0.19	17.8 39.2	9, 10, 11
T611FSA-T611SA	3	317.500 12.5000	317.500 12.5000	87.313 3.4375	–	–	228.600 9.0000	8810 1980000	762.0 30.00	6.4 0.25	–	29.3 64.6	9, 10, 11
T611FS-T611SA	3	317.500 12.5000	317.500 12.5000	87.313 3.4375	–	152.400 6.0000	228.600 9.0000	8810 1980000	762.0 30.00	6.4 0.25	6.4 0.25	29.3 64.6	9, 10, 11

⁽¹⁾Contact your Timken engineer.

NOTE: Spec. = Special tolerance structure, contact your Timken engineer.

Continued on next page.

THRUST TAPERED ROLLER BEARINGS – SCREWDOWN BEARINGS – TYPES TTHDSX/SV AND TTHDFLSX/SV

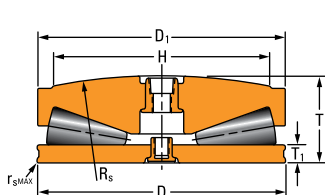

Fig. 1

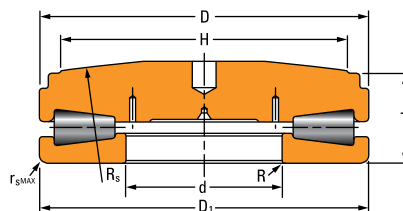

Fig. 3

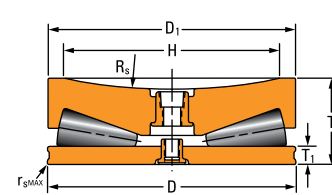

Fig. 7

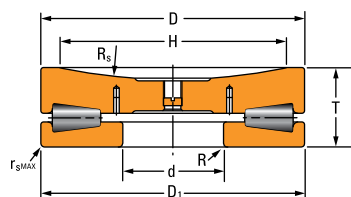

Fig. 8

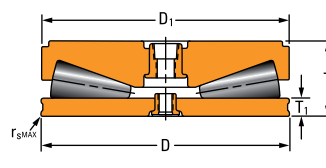

Fig. 10

Continued from previous page.

Bearing Part Number	Figure No.	Bearing Dimensions						Static Load Rating	Mounting Dimensions			Bearing Weight	Tolerance Table
		Large O.D.	Small O.D.	Bearing Width	Flat Race Width	Bore	Screw Extension Diameter		Spherical Radius	r _{s max}	R		
		D	D ₁	T	T ₁	d	H		R _s				
mm in.	mm in.	mm in.	mm in.	mm in.	mm in.	mm in.	mm in.	mm in.	mm in.	kg lbs.			
126 TTSV 922	7	320.675 12.6250	318.313 12.5320	95.250 3.7500	22.225 0.8750	–	279.400 11.0000	12540 2820000	381.0 15.00	1.6 0.06	–	55.4 122.2	10, 11
126 TTSV 922 OD617	7	320.675 12.6250	318.313 12.5320	127.000 5.0000	22.225 0.8750	–	228.600 9.0000	12540 2820000	533.4 21.00	1.5 0.06	–	55.4 122.2	10, 11
126 TTSX 922 C0740	1	320.675 12.6250	318.313 12.5320	110.973 4.3690	22.225 0.8750	–	279.400 11.0000	12540 2820000	762.0 30.00	1.5 0.06	–	64.6 142.3	10, 11
126 TTSX 922 OC076	1	320.675 12.6250	318.313 12.5320	126.187 4.9680	22.225 0.8750	–	279.400 11.0000	12540 2820000	762.0 30.00	1.5 0.06	–	64.6 142.3	10, 11
126 TTSX 922 E01984	1	329.938 12.9897	318.313 12.5320	110.973 4.3690	22.225 0.8750	–	279.400 11.0000	12540 2820000	762.0 30.00	1.8 0.07	–	64.0 140.0	Spec.
T711FSS-T711SA	8	368.300 14.5000	368.300 14.5000	104.775 4.1250	–	–	292.100 11.5000	11880 2670000	622.3 24.50	7.9 0.31	–	81.7 180.0	9, 10, 11
T711FS-T711SA	3	368.300 14.5000	368.300 14.5000	101.600 4.0000	–	177.800 7.0000	298.450 11.7500	11880 2670000	762.0 30.00	7.9 0.31	7.9 0.31	48.4 106.7	9, 10, 11
148 TTSF926 O0487	10	377.825 14.8750	375.463 14.7820	129.007 5.0790	25.400 1.0000	–	–	17440 3920000	–	1.5 0.06	–	110.0 243.0	10, 11
148 TTSV 926 A0529	7	377.825 14.8750	375.463 14.7820	111.125 4.3750	25.400 1.0000	–	330.200 13.0000	17440 3920000	457.2 18.00	1.5 0.06	–	(1)	10, 11
148 TTSX 926	1	377.825 14.8750	451.663 17.7820	129.007 5.0790	25.400 1.0000	–	330.200 13.0000	17440 3920000	914.4 36.00	1.6 0.06	–	104.2 229.7	10, 11
148 TTSX 926 B0024	1	377.825 14.8750	375.463 14.7820	141.707 5.5790	38.100 1.5000	–	330.200 13.0000	17440 3920000	914.4 36.00	1.5 0.06	–	104.2 229.7	10, 11
148 TTSX 926 OB452	1	377.825 14.8750	375.463 14.7820	129.007 5.0790	25.400 1.0000	–	330.200 13.0000	17440 3920000	711.2 28.00	1.5 0.06	–	104.2 229.7	10, 11
148 TTSX 926 OD806	1	377.825 14.8750	374.650 14.7500	129.007 5.0790	25.400 1.0000	–	330.200 13.0000	17440 3920000	1384.3 54.50	1.5 0.06	–	104.2 229.7	10, 11
161 TTSV 930 OA534	7	409.575 16.1250	407.213 16.0320	139.700 5.5000	28.575 1.1250	–	330.200 13.0000	20420 4590000	508.0 20.00	3.0 0.12	–	(1)	10, 11
161 TTSX 930	1	409.575 16.1250	407.213 16.0320	140.767 5.5420	28.575 1.1250	–	355.600 14.0000	20420 4590000	1016.0 40.00	3.2 0.13	–	134.8 297.1	10, 11

(1) Contact your Timken engineer.

NOTE: Spec. = Special tolerance structure, contact your Timken engineer.

Continued on next page.

THRUST BEARING DATA

THRUST TAPERED ROLLER BEARINGS – SCREWDOWN BEARINGS – TYPES TTHDSX/SV AND TTHDFLSX/SV

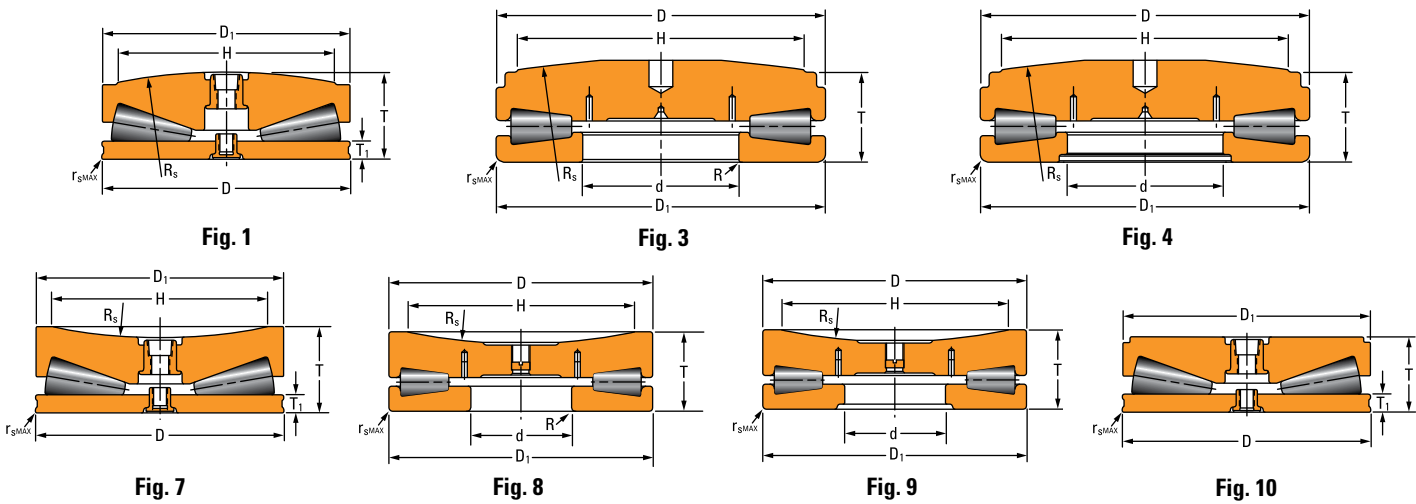

TABLE 49. SCREWDOWN BEARINGS – TYPES TTHDSX/SV AND TTHDFLSX/SV – continued

Bearing Part Number	Figure No.	Bearing Dimensions						Static Load Rating C_{a0} kN lbf.	Mounting Dimensions			Bearing Weight kg lbs.	Tolerance Table
		Large O.D.	Small O.D.	Bearing Width	Flat Race Width	Bore	Screw Extension Diameter		Spherical Radius				
		D	D ₁	T	T ₁	d	H		R _s	r _{s max}	R		
		mm in.	mm in.	mm in.	mm in.	mm in.	mm in.	mm in.	mm in.	mm in.	kg lbs.		
161 TTSX 930 D0035	1	409.575 16.1250	407.213 16.0320	140.767 5.5420	28.575 1.1250	–	355.600 14.0000	20420 4590000	1016.0 40.00	3.0 0.12	–	134.8 297.1	10, 11
T811FSA-T811SB	8	422.275 16.6250	419.100 16.5000	120.650 4.7500	–	–	342.900 13.5000	15080 3390000	508.0 20.00	9.7 0.38	–	104.0 229.3	9, 10, 11
T811FS-T811SA	3	422.275 16.6250	419.100 16.5000	115.888 4.5625	–	203.200 8.0000	342.900 13.5000	15080 3390000	838.2 33.00	9.7 0.38	9.7 0.38	106.3 234.3	9, 10, 11
172 TTSF 934	10	438.150 17.2500	435.788 17.1570	130.175 5.1250	31.750 1.2500	–	–	23840 5360000	–	3.0 0.12	–	(1)	10, 11
172 TTSV 934 BA528	7	438.150 17.2500	435.788 17.1570	149.225 5.8750	50.800 2.0000	–	381.000 15.0000	23840 5360000	1270.0 50.00	–	–	(1)	10, 11
172 TTSX 934	1	438.150 17.2500	435.788 17.1570	150.673 5.9320	130.175 5.1250	–	381.000 15.0000	23840 5360000	1016.0 40.00	3.0 0.12	–	163.6 360.8	10, 11
D-2271-C	10	438.150 17.2500	438.150 17.2500	130.175 5.1250	31.750 1.2500	–	–	23840 5360000	–	3.2 0.13	–	141.4 311.7	10, 11
S-3229-B	7	457.200 18.0000	448.462 17.6560	161.925 6.3750	31.750 1.2500	–	336.550 13.2500	26290 5910000	508.0 20.00	3.0 0.12	–	(1)	10, 11
190 TTSX 940 OA617	1	482.600 19.0000	480.187 18.9050	152.781 6.0150	38.100 1.5000	–	419.100 16.5000	29220 6570000	1066.8 42.00	1.5 0.06	–	170.8 376.4	10, 11
B-6096-C	7	482.600 19.0000	482.600 19.0000	146.050 5.7500	38.291 1.5075	–	431.800 17.0000	27930 6280000	1270.0 50.00	–	–	171.2 377.4	Spec.
B-6593-C	7	482.600 19.0000	482.600 19.0000	152.400 6.0000	44.641 1.7575	–	431.800 17.0000	6310 28070000	1270.0 50.00	–	–	131.5 290.0	Spec.
T9030FSA-T9030SA	4	482.600 19.0000	482.600 19.0000	131.763 5.1875	–	168.275 6.6250	419.100 16.5000	20640 4640000	1295.4 51.00	11.2 0.44	–	170.2 375.2	9, 10, 11
T9030FSA-T9030SB	4	482.600 19.0000	482.600 19.0000	131.763 5.1875	–	168.275 6.6250	419.100 16.5000	20640 4640000	1066.8 42.00	11.2 0.44	–	170.2 375.2	9, 10, 11
T9030FS-T9030SA	3	482.600 19.0000	482.600 19.0000	150.622 5.9300	–	–	419.100 16.5000	20640 4640000	1295.4 51.00	11.2 0.44	–	204.6 451.0	9, 10, 11
T911FS-T911S	9	482.600 19.0000	482.600 19.0000	146.050 5.7500	–	228.600 9.0000	428.625 16.8750	20280 4560000	608.3 23.95	11.2 0.44	–	149.8 330.2	9, 10, 11

(1) Contact your Timken engineer.

NOTE: Spec. = Special tolerance structure, contact your Timken engineer.

Continued on next page.

THRUST TAPERED ROLLER BEARINGS – SCREWDOWN BEARINGS – TYPES TTHDSX/SV AND TTHDFLSX/SV

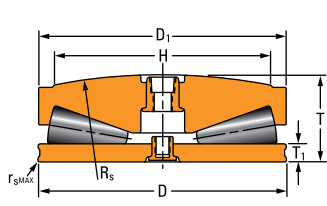

Fig. 1

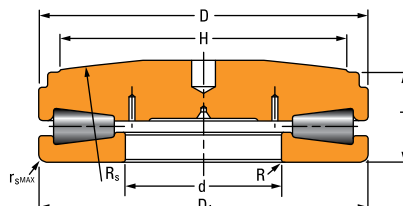

Fig. 3

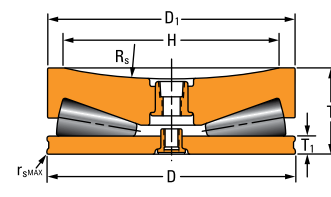

Fig. 7

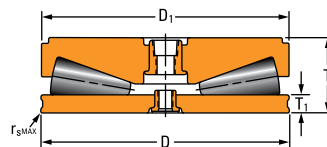

Fig. 10

Continued from previous page.

Bearing Part Number	Figure No.	Bearing Dimensions						Static Load Rating C_{a0}	Mounting Dimensions			Bearing Weight	Tolerance Table
		Large O.D.	Small O.D.	Bearing Width	Flat Race Width	Bore	Screw Extension Diameter		Spherical Radius	$r_{s\ max}$	R		
		D	D ₁	T	T ₁	d	H		R_s				
mm in.	mm in.	mm in.	mm in.	mm in.	mm in.	mm in.	mm in.	mm in.	mm in.	kg lbs.			
T9030FSB-T9030SC	3	492.811 19.4020	495.249 19.4980	145.288 5.7200	–	–	431.800 17.0000	20640 4640000	1066.8 42.00	3.0 0.12	–	(1)	9, 10, 11
195 TTSF 938	10	495.300 19.5000	492.938 19.4070	145.288 5.7200	34.925 1.3750	–	–	29540 6640000	–	3.0 0.12	–	184.5 406.7	10, 11
195 TTSV 938 OA452	7	495.300 19.5000	492.938 19.4070	146.050 5.7500	34.925 1.3750	–	431.800 17.0000	29540 6640000	635.0 25.00	3.2 0.13	–	162.8 358.9	10, 11
195 TTSV 938 OC902	7	495.300 19.5000	488.950 19.2500	146.050 5.7500	34.925 1.3750	–	431.800 17.0000	29540 6640000	635.0 25.00	3.0 0.12	–	162.8 358.9	10, 11
195 TTSX 938	1	495.300 19.5000	492.938 19.4070	170.612 6.7170	34.925 1.3750	–	431.800 17.0000	29540 6640000	1066.8 42.00	3.0 0.12	–	205.4 452.7	10, 11
195 TTSX 938 GO1185	1	495.300 19.5000	492.938 19.4070	170.612 6.7170	34.925 1.3750	–	431.800 17.0000	29540 6640000	1066.8 42.00	3.0 0.12	–	204.4 450.7	10, 11
195 TTSX 938 OG547	1	495.300 19.5000	495.300 19.5000	170.612 6.7170	34.925 1.3750	–	431.800 17.0000	29540 6640000	1066.8 42.00	3.0 0.12	–	204.4 450.7	Spec.
195 TTSX 938 OM1907	1	495.300 19.5000	492.938 19.4070	170.612 6.7170	34.925 1.3750	–	431.800 17.0000	29540 6640000	1066.8 42.00	3.0 0.12	–	204.4 450.7	10, 11
202 TTSX 942 FE1199	1	514.350 20.2500	521.513 20.5320	188.722 7.4300	34.925 1.3750	–	403.225 15.8750	35630 8010000	635.0 25.00	1.5 0.06	–	238.5 525.9	10, 11
206 TTSV 942	7	523.875 20.6250	521.513 20.5320	152.400 6.0000	34.925 1.3750	–	457.200 18.0000	35630 8010000	635.0 25.00	3.0 0.12	–	190.8 420.6	10, 11
206 TTSX 942	1	523.875 20.6250	521.513 20.5320	175.768 6.9200	34.925 1.3750	–	457.200 18.0000	35630 8010000	1270.0 50.00	3.0 0.12	–	258.0 568.0	10, 11
206 TTSX 942 B0529	1	523.875 20.6250	521.513 20.5320	175.768 6.9200	34.925 1.3750	–	457.200 18.0000	35630 8010000	1270.0 50.00	3.2 0.13	–	258.0 568.0	10, 11
210 TTSV 944 CA1481	7	533.400 21.0000	533.400 21.0000	177.800 7.0000	31.750 1.2500	–	457.200 18.0000	36650 8240000	1270.0 50.00	1.5 0.06	–	257.0 567.0	Spec.
210 TTSV 944 DA1708	7	533.400 21.0000	533.400 21.0000	190.500 7.5000	44.450 1.7500	–	457.200 18.0000	36650 8240000	1270.0 50.00	–	–	279.5 616.0	Spec.
210 TTSX 944 A0574	1	533.400 21.0000	531.012 20.9060	177.800 7.0000	31.750 1.2500	–	457.200 18.0000	36650 8240000	1981.2 78.00	–	–	249.1 549.2	10, 11

(1)Contact your Timken engineer.

NOTE: Spec. = Special tolerance structure, contact your Timken engineer.

Continued on next page.

THRUST BEARING DATA

THRUST TAPERED ROLLER BEARINGS – SCREWDOWN BEARINGS – TYPES TTHDSX/SV AND TTHDFLSX/SV

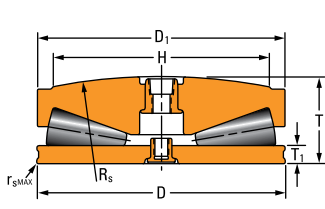

Fig. 1

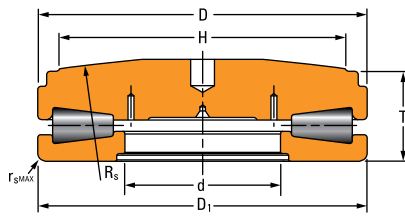

Fig. 4

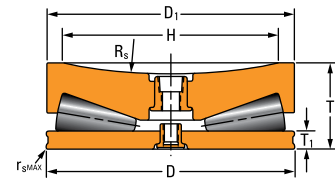

Fig. 7

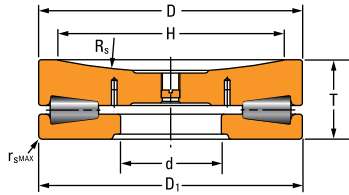

Fig. 9

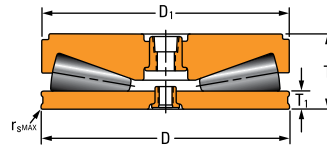

Fig. 10

TABLE 49. SCREWDOWN BEARINGS – TYPES TTHDSX/SV AND TTHDFLSX/SV – continued

Bearing Part Number	Figure No.	Bearing Dimensions						Static Load Rating	Mounting Dimensions			Bearing Weight	Tolerance Table
		Large O.D.	Small O.D.	Bearing Width	Flat Race Width	Bore	Screw Extension Diameter		Spherical Radius				
		D	D ₁	T	T ₁	d	H		R _s	r _{s max}	R		
		mm in.	mm in.	mm in.	mm in.	mm in.	mm in.	kN lbf.	mm in.	mm in.	mm in.	kg lbs.	
210 TTSX 944 BA1479	1	533.400 21.0000	533.400 21.0000	177.800 7.0000	31.750 1.2500	–	457.200 18.0000	36650 8240000	1981.2 78.00	–	–	271.0 598.0	10, 11
B-6435-C	7	533.400 21.0000	–	190.500 7.5000	50.991 2.0075	–	–	37630 8460000	1270.0 50.00	–	–	(1)	Spec.
D-2272-C	1	533.400 21.0000	533.400 21.0000	190.500 7.5000	31.750 1.2500	–	469.392 18.4800	39190 8810000	1220.8 48.06	2.5 0.10	–	224.2 494.3	Spec.
A-6639-A	1	533.451 21.0020	533.400 21.0000	190.500 7.5000	31.750 1.2500	–	469.392 18.4800	39190 8810000	1235.5 48.64	2.5 0.10	–	287.0 673.0	Spec.
210 TTSF 944	10	535.991 21.1020	535.991 21.1020	189.992 7.4800	31.750 1.2500	–	–	36650 8240000	–	2.0 0.08	–	274.0 604.0	Spec.
212 TTSV 942 EB1876	7	539.750 21.2500	539.750 21.2500	196.850 7.7500	41.275 1.6250	–	406.400 16.0000	35630 8010000	635.0 25.00	11.2 0.44	–	288.0 635.0	Spec.
T1011FS-T1011S	4	539.750 21.2500	539.750 21.2500	149.225 5.8750	–	254.000 10.0000	447.751 17.6280	25670 5770000	1066.8 42.00	11.2 0.44	–	225.8 497.8	9, 10, 11
T9250FS-T9250S	9	546.100 21.5000	546.100 21.5000	168.275 6.6250	–	234.950 9.2500	457.200 18.0000	29980 6740000	641.4 25.25	16.0 0.63	–	222.2 489.8	9, 10, 11
T9250FAS-T9250SA	4	549.275 21.6250	546.100 21.5000	155.575 6.1250	–	139.700 5.5000	457.200 18.0000	29980 6740000	1295.4 51.00	16.0 0.63	–	265.7 585.8	9, 10, 11
M-4153-C	7	551.688 21.7200	539.750 21.2500	158.369 6.2350	25.400 1.0000	–	406.400 16.0000	35900 8070000	635.0 25.00	3.0 0.12	–	294.8 650.0	10, 11
218 TTSV 946	7	555.625 21.8750	553.263 21.7820	165.100 6.5000	38.100 1.5000	–	482.600 19.0000	38340 8620000	635.0 25.00	3.2 0.13	–	288.4 635.7	10, 11
218 TTSX 946	1	555.625 21.8750	553.263 21.7820	190.856 7.5140	38.100 1.5000	–	482.600 19.0000	38340 8620000	1270.0 50.00	3.0 0.12	–	284.4 626.9	10, 11
B-6903-C	1	555.625 21.8750	553.263 21.7820	227.787 8.9680	63.500 2.5000	–	425.450 16.7500	32870 7390000	1930.4 76.00	–	–	352.5 777.1	Spec.
B-8867-G	1	555.625 21.8750	553.263 21.7820	201.828 7.9460	38.100 1.5000	–	482.600 19.0000	37540 8440000	1930.4 76.00	–	–	373.0 867.0	10, 11
S-4674-G	10	577.850 22.7500	581.025 22.8750	228.600 9.0000	50.800 2.0000	–	–	43500 9780000	–	–	–	434.0 957.0	Spec.

(1) Contact your Timken engineer.

NOTE: Spec. = Special tolerance structure, contact your Timken engineer.

Continued on next page.

THRUST TAPERED ROLLER BEARINGS – SCREWDOWN BEARINGS – TYPES THDSX/SV AND TTHDLSX/SV

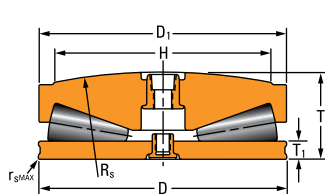

Fig. 1

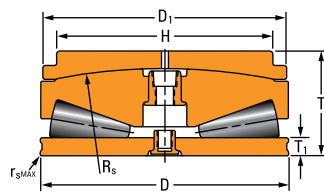

Fig. 2

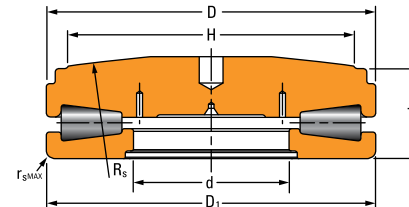

Fig. 4

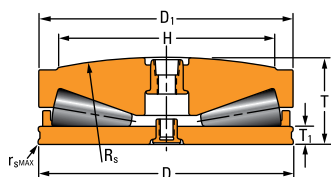

Fig. 5

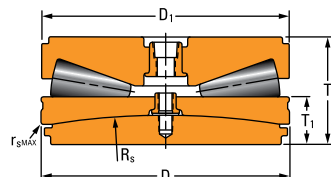

Fig. 6

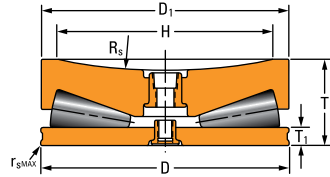

Fig. 7

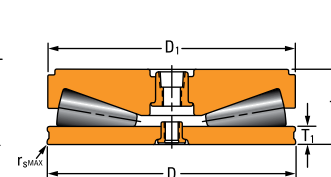

Fig. 10

Continued from previous page.

Bearing Part Number	Figure No.	Bearing Dimensions						Static Load Rating C_{a0}	Mounting Dimensions			Bearing Weight	Tolerance Table
		Large O.D.	Small O.D.	Bearing Width	Flat Race Width	Bore	Screw Extension Diameter		Spherical Radius	$r_{s\max}$	R		
		D	D_1	T	T_1	d	H		R_s				
228 TTSF 950 BA1668	10	581.025 22.8750	578.663 22.7820	167.894 6.6100	38.100 1.5000	–	–	43500 9780000	–	3.0 0.12	–	297.0 655.0	23, 23
228 TTSX 950	1	581.025 22.8750	578.663 22.7820	193.777 7.6290	38.100 1.5000	–	508.000 20.0000	43500 9780000	1422.4 56.00	3.0 0.12	–	318.0 701.1	10, 11
228 TTSX 950 A02017	1	581.025 22.8750	578.663 22.7820	193.777 7.6290	38.100 1.5000	–	508.000 20.0000	43500 9780000	1422.4 56.00	3.0 0.12	–	431.0 950.0	10, 11
S-3632-C	6	581.025 22.8750	581.025 22.8750	240.005 9.4490	107.950 4.2500	–	–	39140 8800000	1270.0 50.00	1.5 0.06	–	(1)	Spec.
R-3355-A	1	603.250 23.7500	601.675 23.6880	207.620 8.1740	44.450 1.7500	–	495.300 19.5000	43500 9780000	1308.1 51.50	4.8 0.19	–	431.0 950.0	Spec.
T1120FS-T1120S	4	603.250 23.7500	603.250 23.7500	161.925 6.3750	–	279.400 11.0000	482.600 19.0000	33410 7510000	1308.1 51.50	11.2 0.44	–	306.4 675.6	9, 10, 11
240 TTSF 954	10	609.600 24.0000	607.238 23.9070	177.038 6.9700	38.100 1.5000	–	–	48930 11000000	–	3.0 0.12	–	(1)	Spec.
240 TTSX 954	1	609.600 24.0000	607.238 23.9070	204.013 8.0320	38.100 1.5000	–	533.400 21.0000	48930 11000000	1524.0 60.00	3.0 0.12	–	370.4 816.6	10, 11
S-21292-C	2	609.600 24.0000	710.006 27.9530	253.660 9.9866	38.037 1.4975	–	585.000 23.0315	48930 11000000	1524.0 60.00	3.3 0.13	–	494.0 1088.0	Spec.
T-5263-C	10	638.226 25.1270	–	184.150 7.2500	38.100 1.5000	–	–	53380 12000000	–	3.0 0.12	–	(1)	Spec.
252 TTSF 958	10	641.350 25.2500	638.988 25.1570	205.740 8.1000	38.100 1.5000	–	–	52930 11900000	–	3.0 0.12	–	432.0 952.0	10, 11
252 TTSV 958	7	641.350 25.2500	638.988 25.1570	184.150 7.2500	38.100 1.5000	–	558.800 22.0000	52930 11900000	762.0 30.00	3.2 0.13	–	580.0 858.0	10, 11
252 TTSX 958	1	641.350 25.2500	638.988 25.1570	212.674 8.3730	38.100 1.5000	–	558.800 22.0000	52930 11900000	1524.0 60.00	3.0 0.12	–	424.0 933.0	10, 11
N-21041-B	1	641.350 25.2500	638.988 25.1570	212.674 8.3730	38.100 1.5000	–	558.800 22.0000	52930 11900000	1524.0 60.00	3.0 0.12	–	424.0 934.0	10, 11
B-9122-A	5	692.150 27.2500	689.762 27.1560	233.629 9.1980	38.100 1.5000	–	590.550 23.2500	52490 11800000	1524.0 60.00	3.0 0.12	–	603.0 1329.0	Spec.

(1) Contact your Timken engineer.

NOTE: Spec. = Special tolerance structure, contact your Timken engineer.

THRUST BEARING DATA

THRUST TAPERED ROLLER BEARING – TYPES TTHDSX/SV AND TTHDFLSX/SV

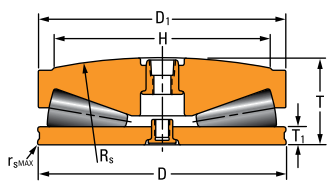

Fig. 1

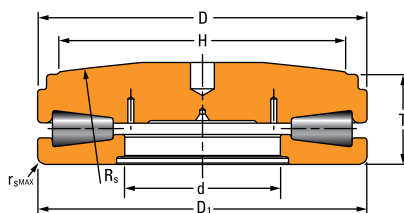

Fig. 4

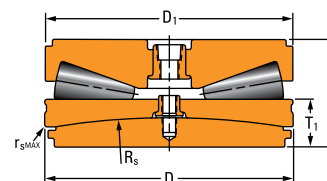

Fig. 6

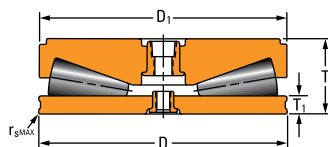

Fig. 10

TABLE 49. SCREWDOWN BEARINGS – TYPES TTHDSX/SV AND TTHDFLSX/SV – continued

Bearing Part Number	Figure No.	Bearing Dimensions						Static Load Rating	Mounting Dimensions			Bearing Weight	Tolerance Table
		Large O.D.	Small O.D.	Bearing Width	Flat Race Width	Bore	Screw Extension Diameter		Spherical Radius				
		D	D ₁	T	T ₁	d	H		R _s	r _{s max}	R		
		mm in.	mm in.	mm in.	mm in.	mm in.	mm in.	mm in.	mm in.	mm in.	kg lbs.		
S-4718-A	1	840.000 33.0709	838.000 32.9920	281.610 11.0870	44.450 1.7500	–	725.000 28.5430	91190 20500000	1524.0 60.00	–	–	986.0 2174.0	Spec.
V-505-A	10	840.000 33.0709	838.000 32.9920	249.619 9.8275	44.450 1.7500	–	–	91190 20500000	–	3.2 0.13	–	916.0 2019.0	10, 11
N-21100-C	6	850.000 33.4646	850.000 33.4646	360.000 14.1732	194.350 7.6515	–	–	78290 17600000	1500.0 59.06	–	–	1350.0 2955.0	Spec.
T17020FS-T17020S	4	942.975 37.1250	939.800 37.0000	260.350 10.2500	–	431.800 17.0000	762.000 30.0000	82290 18500000	2000.3 78.75	12.7 0.50	–	1260.0 2776.0	9, 10, 11
T12040FS-T12040S	4	1146.175 45.1250	1143.000 45.0000	317.500 12.5000	–	304.800 12.0000	990.600 39.0000	136560 30700000	2000.3 78.75	19.1 0.75	–	2530.0 5577.0	9, 10, 11

⁽¹⁾Contact your Timken engineer.

NOTE: Spec. = Special tolerance structure, contact your Timken engineer.

TYPE TTDWK AND TTDFLK

- Double-acting thrust tapered roller bearing construction.
- Used extensively on work roll axial positions in metals rolling mill applications where axial loads are very high.
- Design variants include one tapered inner race and two flat outer races, or one flat inner race and two tapered outer races.

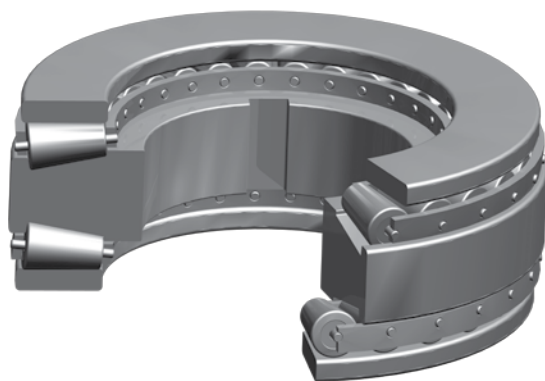

Fig. 100. Type TTDWK double-row thrust tapered roller bearing.

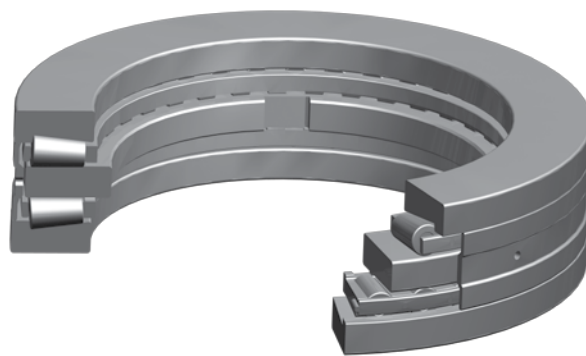

Fig. 101. Type TTDFLK double-row thrust tapered roller bearing.

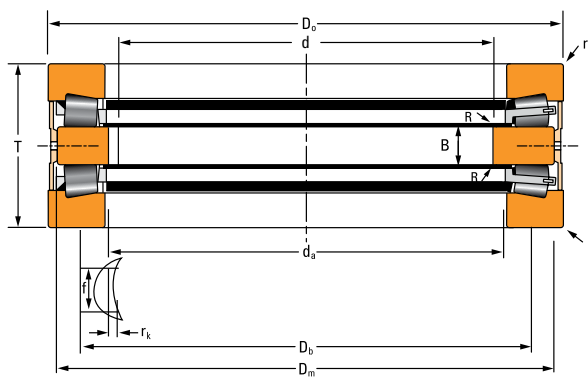

Fig. 102. Type TTDFLK double-row thrust tapered roller bearing assembly.

OVERALL DIMENSIONS:

- d – Bore diameter
- D_0 – Outer rings O.D.
- D_m – Inner ring O.D.
- D_b – Outer ring backing diameter
- T – Bearing width
- B – Inner ring width
- R – Shaft maximum fillet radius
- r – Housing maximum fillet radius
- r_k – Keyway height
- f – Keyway width
- b – Keyway depth (where applicable)

DESIGN TYPES

TTDW

- Two single flat outer races.
- One double tapered inner race with extended ribs.
- Oil slots on double race faces.

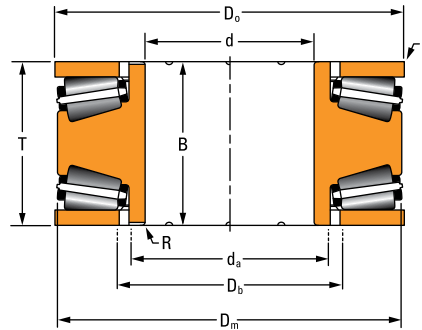

Fig. 103. Type TTDW.

TTDK 1

- Two single flat outer races.
- One double tapered inner race.
- Inner-ring bore keyway.

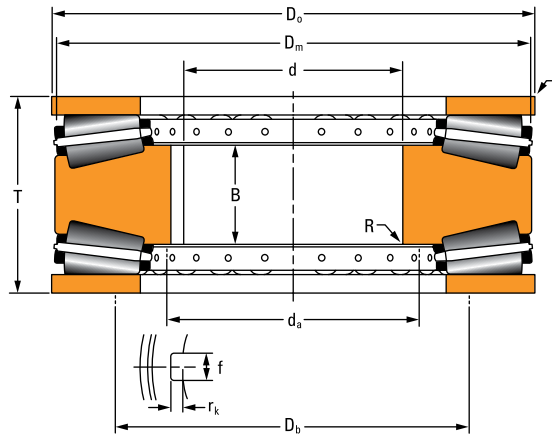

Fig. 104. Type TTDK 1.

TTDK 2

- Two single flat outer races.
- One double tapered inner race.
- One outer-ring spacer with oil groove.

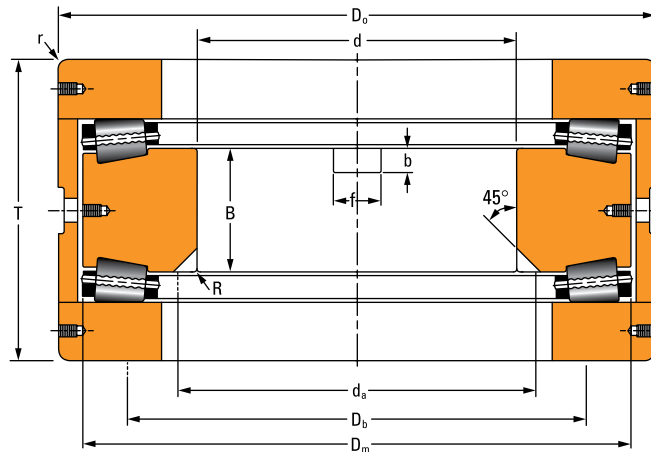

Fig. 105. Type TTDK 2.

TTDFLK 1

- Two single tapered outer races.
- One flat inner race.
- Inner-ring bore keyway (optional).
- One outer-ring spacer with oil slots.

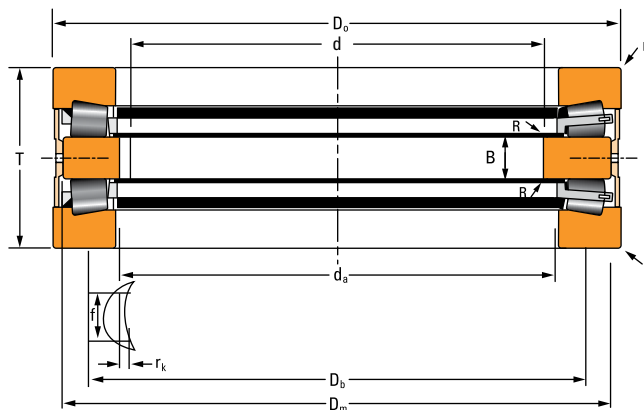

Fig. 106. Type TTDFLK 1.

TTDFLK 2

- Two single tapered outer races.
- One flat inner race.
- Inner-ring face keyway (optional).
- One outer-ring spacer with oil slots.

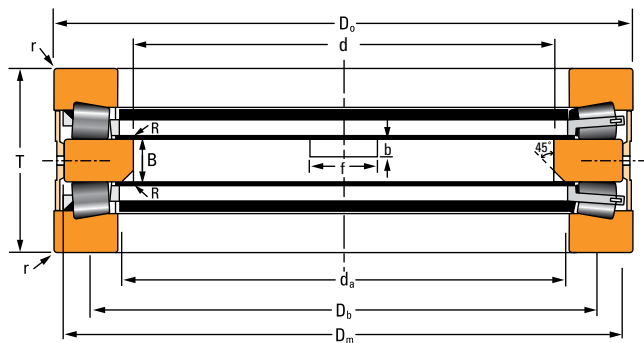

Fig. 107. Type TTDFLK 2.

THRUST BEARING DATA

THRUST TAPERED ROLLER BEARINGS – TYPES TTDWK AND TTDFLK

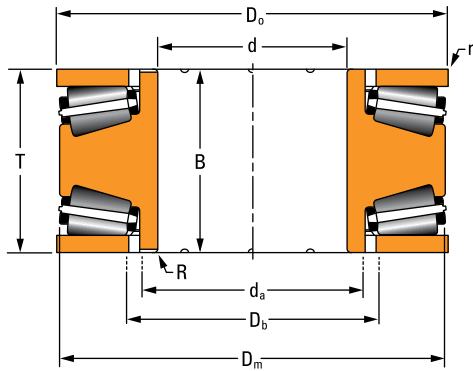

Fig. 1

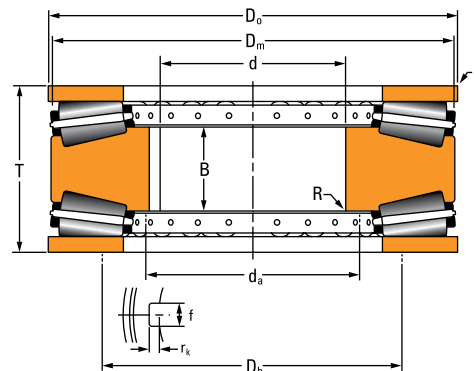

Fig. 2

TABLE 50. THRUST TAPERED ROLLER BEARINGS – TYPES TTDWK AND TTDFLK

Bearing Part Number		Figure No.	Bearing Dimensions				Cage Type ⁽¹⁾	
Thrust Race Double	Thrust Race Single		Bore	O.D.		Bearing Width		Inner Ring Width
			d	D_o	D_m	T		B
		mm in.	mm in.	mm in.	mm in.	mm in.		
T660DW	T660FA	2	142.000 5.5906	293.000 11.5354	304.800 12.0000	130.000 5.1180	55.000 2.1654	P
T730DW	T730FA	2	170.000 6.6929	249.970 9.8413	246.913 9.7210	70.000 2.7559	19.000 0.7480	P
T6110F	T6110	4	170.000 6.6929	240.000 9.4488	228.600 9.0000	84.000 3.3070	20.000 0.7874	MB
T770DW	T770FA	2	180.000 7.0866	279.975 11.0226	275.000 10.8268	90.000 3.5433	31.826 1.2490	P
H-21033-B	-	4	180.000 7.0866	280.000 11.0236	263.000 10.3500	90.000 3.5433	20.000 0.7874	MB
T7020F	T7020	4	180.000 7.0866	280.000 11.0236	265.000 10.4330	90.000 3.5433	20.000 0.7874	MB
T8011DW	T8011F	2	203.200 8.0000	390.855 15.3880	403.860 15.9000	152.400 6.0000	72.898 2.8700	P
T8010DW	T8010F	1	203.200 8.0000	431.317 16.9810	403.860 15.9000	152.400 6.0000	152.400 6.0000	P
T8110F	T8110	4	220.000 8.6614	300.000 11.8110	289.000 11.3770	96.000 3.7795	22.000 0.8661	MB
T1080DW	T1080FA	2	250.000 9.8425	379.949 14.9586	375.000 14.7638	100.000 3.9370	36.576 1.4400	P
T9130FW	T9130	4	250.000 9.8425	380.000 14.9606	364.000 14.3307	100.000 3.9370	22.000 0.8661	MB
T10400F	T10400	4	260.000 10.2362	360.000 14.1732	344.000 13.5433	92.000 3.6620	20.000 0.7874	MB
T10250DW	T10250F	1	260.350 10.2500	584.124 22.9970	533.400 21.0000	222.250 8.7500	222.250 8.7500	P
M-21135-C	H-21120-C	5	291.150 11.4626	519.940 20.4701	480.000 18.8976	265.900 10.4685	118.000 4.6457	MB
T12100F	T12100	4	320.000 12.5984	470.000 18.5039	448.000 17.6378	130.000 5.1181	30.000 1.1811	MB

⁽¹⁾Cage type: P – Pin MB – Machined Bronze

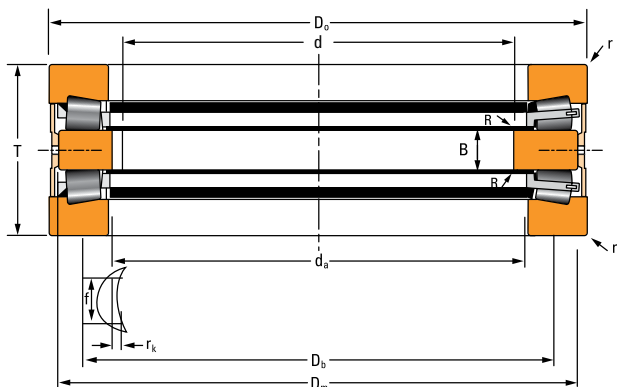

Fig. 4

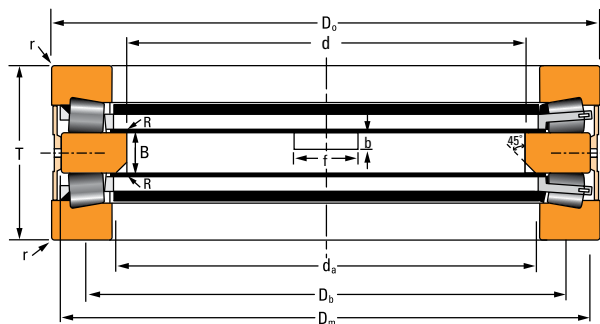

Fig. 5

Mounting Dimensions				Keyway Dimensions			Load Ratings			Bearing Weight
Max Shaft Radius	Inner Ring Backing Diameter	Max. Housing Radius	Outer Ring Backing Diameter	f	b	r_k	Dynamic		Static Load Rating	
							1 Million Revolutions	90 Million Revolutions		
R	d_a	r	D_b				C_{a1}	C_{a90}	C_{a0}	
mm in.	mm in.	mm in.	mm in.	mm in.	mm in.	mm in.	kN lbf.	kN lbf.	kN lbf.	kg lbs.
1.5 0.06	162.0 6.38	3.3 0.13	168.0 6.61	30.0 1.18	–	9.0 0.35	1900 426200	500 111000	6510 1460000	44.0 97.0
1.5 0.06	182.9 7.20	3.3 0.13	186.0 7.32	30.0 1.18	–	6.0 0.24	440 97790	120 25400	1820 408000	8.0 18.0
0.6 0.02	182.0 7.17	2.0 0.08	190.0 7.48	–	–	–	500 112850	130 29225	1600 359690	11.0 24.0
1.5 0.06	192.0 7.56	3.3 0.13	196.0 7.72	30.0 1.18	–	6.0 0.24	720 162470	190 42200	2990 672000	18.0 39.0
1.0 0.04	185.0 7.28	2.0 0.08	254.0 10.00	20.0 0.79	–	4.0 0.16	764 171760	198 44500	2510 564300	22.0 48.0
1.0 0.04	192.0 7.56	2.0 0.08	205.0 8.07	–	–	–	740 167000	190 43160	2410 541790	20.0 44.0
1.5 0.06	236.5 9.31	3.3 0.13	260.4 10.25	30.0 1.18	–	10.0 0.39	2850 639100	740 166000	11900 2670000	133.0 294.0
4.8 0.19	235.0 9.25	2.0 0.08	260.4 10.30	–	–	–	2850 639100	740 166000	11900 2670000	158.0 348.0
1.5 0.06	231.0 9.09	2.0 0.08	245.0 9.65	–	–	–	600 135335	160 35070	2070 465355	19.0 42.0
1.5 0.06	266.7 10.50	3.3 0.13	275.0 10.83	30.0 1.18	–	7.0 0.28	1348 302995	350 78700	6010 1350000	36.0 79.0
0.6 0.02	267.0 10.51	2.0 0.08	285.0 11.22	30.0 1.18	–	6.7 0.26	1200 269770	310 69915	5030 1130790	40.0 88.0
2.0 0.08	276.0 10.87	2.0 0.08	290.0 11.42	–	–	–	810 182320	210 47210	3110 699160	26.0 57.0
7.1 0.28	304.8 12.00	2.0 0.08	355.6 14.00	–	–	–	5570 1249500	1450 324000	21600 4850000	132.0 292.0
4.0 0.16	340.0 13.39	12.7 0.50	493.0 19.40	46.0 1.81	23.0 0.91	–	2510 564270	650 146130	9800 2201300	279.0 616.0
1.1 0.04	340.0 13.39	3.0 0.12	360.0 14.17	–	–	–	1770 397910	460 103190	7670 1724290	75.0 165.0

Continued on next page.

THRUST BEARING DATA

THRUST TAPERED ROLLER BEARINGS – TYPES TTDWK AND TTDFLK

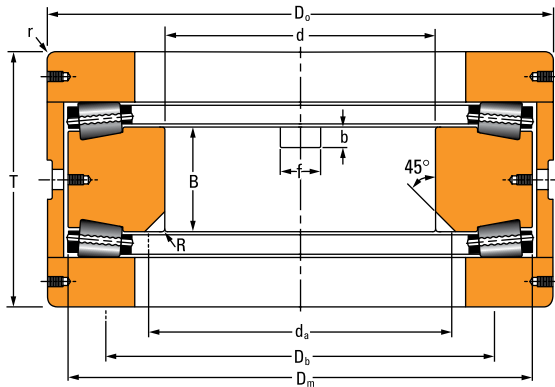

Fig. 3

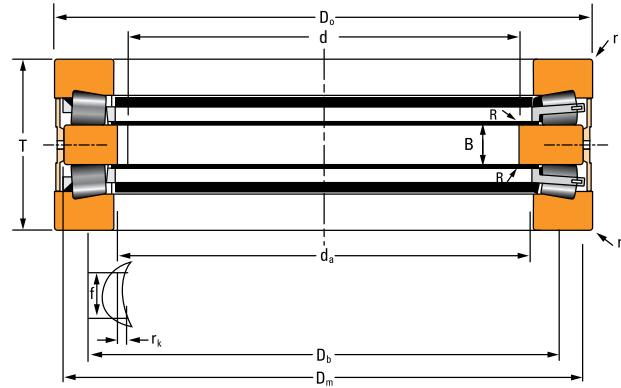

Fig. 4

TABLE 50. THRUST TAPERED ROLLER BEARINGS – TYPES TTDWK AND TTDFLK – continued

Bearing Part Number		Figure No.	Bearing Dimensions					Cage Type ⁽¹⁾
Thrust Race Double	Thrust Race Single		Bore	O.D.		Bearing Width	Inner Ring Width	
			d	D_o	D_m	T	B	
		mm in.	mm in.	mm in.	mm in.	mm in.		
A-6881-A	A-6888-C	5	336.150 13.2343	629.930 24.8004	576.961 22.7150	318.613 12.5438	130.000 5.1181	MB
T13200DW	13200F	3	336.202 13.2363	629.872 24.7981	579.247 22.8050	318.493 12.5391	130.000 5.1181	P
M-21136-C	H-21127-C	5	351.150 13.8248	669.925 26.3750	610.000 24.0157	318.900 12.5551	131.000 5.1575	MB
D-3637-A	D-3639-C	4	380.000 14.9606	560.000 22.0472	538.785 21.2120	130.000 5.1181	32.000 1.2598	MB
T17200FW	T17200	4	385.000 15.1575	650.000 25.5906	614.500 24.1930	240.000 9.4488	66.000 2.5984	MB
T24000	T24000F	4	550.000 21.6535	760.000 29.9213	714.985 28.1490	294.500 11.5945	114.960 4.5260	MB
F-21063-C	F-21068-B	4	550.000 21.6535	760.000 29.9213	715.000 28.1500	230.000 9.0551	49.960 1.9669	MB
D-3327-G	D-3333-C	5	550.000 21.6535	760.000 29.9213	736.600 29.0000	230.000 9.0551	50.013 1.9690	MB

⁽¹⁾Cage type: P – Pin MB – Machined Bronze

⁽²⁾Contact your Timken engineer.

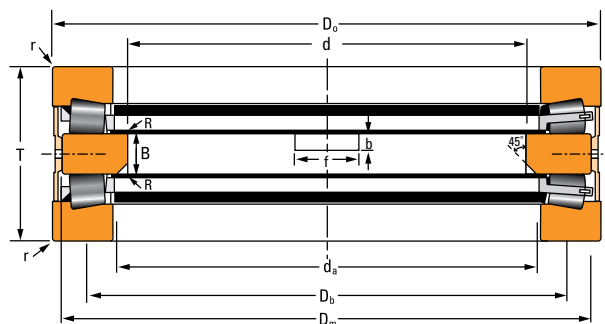

Fig. 5

Mounting Dimensions				Keyway Dimensions			Load Ratings			Bearing Weight
Max Shaft Radius R	Inner Ring Backing Diameter d _a	Max. Housing Radius r	Outer Ring Backing Diameter D _b	f	b	r _k	Dynamic		Static Load Rating C _{a0}	
							1 Million Revolutions C _{a1}	90 Million Revolutions C _{a90}		
mm in.	mm in.	mm in.	mm in.	mm in.	mm in.	mm in.	kN lbf.	kN lbf.	kN lbf.	kg lbs.
4.0 0.16	405.0 15.94	13.0 0.51	588.5 23.17	50.0 1.97	25.0 0.98	– –	4200 944200	1090 245040	18800 4226400	513.0 1130.0
4.1 0.16	401.3 15.80	13.0 0.51	412.0 16.22	50.0 1.97	25.0 0.98	– –	3630 816200	940 212000	15600 3510000	107.0 236.0
3.0 0.12	420.0 16.53	12.7 0.50	622.3 24.50	55.0 2.17	30.0 1.18	– –	4330 973400	1120 251800	18000 4046500	588.0 1295.0
2.8 0.11	420.0 16.54	3.0 0.12	519.1 20.44	45.0 1.77	– –	10.0 0.39	2280 512560	590 133100	10200 2293000	96.0 211.0
3.0 0.12	408.9 16.10	10.2 0.40	456.2 17.96	45.5 1.79	– –	25.4 1.00	4850 1090320	1260 283260	18800 4226410	282.0 621.0
3.0 0.12	580.0 22.83	6.0 0.24	704.5 27.74	45.1 1.78	– –	9.9 0.39	3610 812000	940 211000	13900 3120000	373.3 823.0
3.0 0.12	575.0 22.64	6.0 0.24	705.0 27.75	45.1 1.78	– –	9.9 0.39	3620 813800	940 210870	13900 3124850	310.0 683.0
3.0 0.12	609.6 24.00	6.4 0.25	717.6 28.25	50.8 2.00	19.0 0.75	– –	4020 903700	1040 233800	16600 3731800	(2)

CROSSED ROLLER BEARINGS – TYPE TXR

- Compact design which offers lowest possible center of gravity in precision rotational applications.
- Stability of bearings greatly enhanced by effective spread and high stiffness of crossed roller set.
- Ideal choice for table bearing for vertical machining operations
- Provides low starting torque.
- Simplified construction facilitates installation and adjustments.
- Offered in various precision classes.



Fig. 108. Type TXR crossed roller bearing.

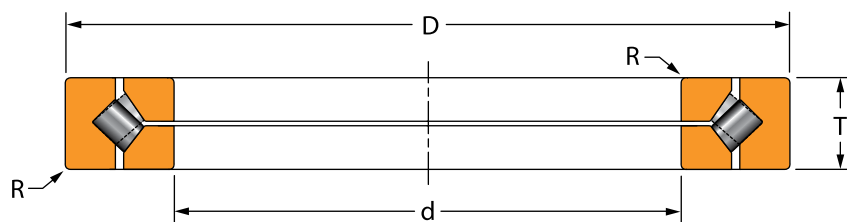

OVERALL DIMENSIONS:

- d – Bore diameter
- D – Bearing O.D.
- T – Bearing width
- R – Shaft/housing maximum fillet radius

Fig. 109. Type TXR crossed roller bearing assembly.

THRUST BEARING DATA

THRUST TAPERED ROLLER BEARINGS – CROSSED ROLLER BEARINGS – TYPE TXR

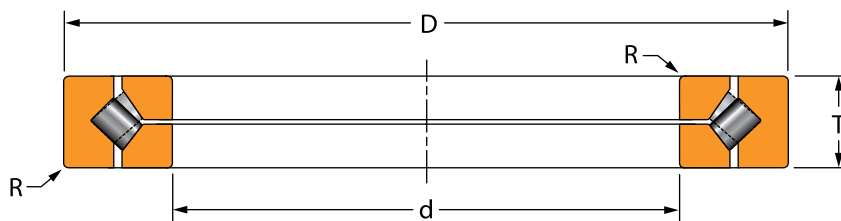

TABLE 51. CROSSED ROLLER BEARINGS – TYPE TXR

Bearing Part Number	Bearing Dimensions			Fillet ⁽¹⁾ Radius (Max.) R	Load Ratings ⁽²⁾		Preload ^(4,5) mm in..	K-Factor ⁽⁶⁾ K	Bearing Weight kg lbs.
	O.D. D	Bore d	Width T		Radial ⁽³⁾ Load Rating	Axial Load Rating			
	mm in.	mm in.	mm in.	mm in.	kN lbf.	kN lbf.			
XR496051	279.400 11.0000	203.200 8.0000	31.750 1.2500	1.5 0.06	51 11500	62 13800	0.025 to 0.040 0.001 to 0.0015	0.48	6.1 13.0
JXR637050 ⁽⁷⁾	400.000 15.7480	300.000 11.8110	37.000 1.4567	1.5 0.06	63 14200	80 18000	0.025 to 0.040 0.001 to 0.0015	0.45	13.0 28.0
JXR652050 ⁽⁷⁾	425.000 16.7323	310.000 12.2047	45.000 1.7717	2.5 0.10	82 18500	102 23000	0.025 to 0.040 0.001 to 0.0015	0.46	25.0 55.0
XR678052	457.200 18.0000	330.200 13.0000	63.500 2.5000	3.3 0.13	100 22500	123 27600	0.040 to 0.050 0.0015 to 0.002	0.47	34.8 77.0
JXR699050 ⁽⁷⁾	495.000 19.4882	370.000 14.5669	50.000 1.9685	3.0 0.12	94 21000	119 26700	0.040 to 0.050 0.0015 to 0.002	0.45	76.0 167.0
XR766051	609.600 24.0000	457.200 18.0000	63.500 2.5000	3.3 0.13	141 31600	178 40100	0.040 to 0.050 0.0015 to 0.002	0.45	57.4 127.0
XR820060	760.000 29.9213	580.000 22.8346	80.000 3.1496	6.4 0.25	240 53900	299 67200	0.075 to 0.100 0.003 to 0.004	0.46	102.0 225.0
XR855053	914.400 36.0000	685.800 27.0000	79.375 3.1250	3.3 0.13	270 60700	344 77200	0.075 to 0.100 0.003 to 0.004	0.45	155.5 343.0
XR882055	1117.600 44.0000	901.700 35.5000	82.550 3.2500	3.3 0.13	300 67400	396 88900	0.100 to 0.150 0.004 to 0.006	0.44	195.8 432.0
XR889058	1327.150 52.2500	1028.700 40.5000	114.300 4.5000	3.3 0.13	405 91000	534 120000	0.125 to 0.180 0.005 to 0.007	0.44	436.3 962.0
XR897051	1828.800 72.0000	1549.400 61.0000	101.600 4.0000	3.3 0.13	518 116000	699 157000	0.150 to 0.200 0.006 to 0.008	0.43	512.9 1131.0

⁽¹⁾Maximum shaft or housing fillet radius that bearing corners will clear.

⁽²⁾Load calculations based on 500 RPM for 3000 hours.

⁽³⁾Two-row radial load rating shown.

⁽⁴⁾Preload set by adjustments to top inner ring clamping spacer plate.

⁽⁵⁾Values listed apply to lower speed applications. Other preload values are available on request. Contact your Timken representative.

⁽⁶⁾K-factor is a ratio of radial load rating to axial load rating.

⁽⁷⁾Metric size TXR.

NOTE: Application of preload values assumes suggested fitting practice in Engineering Section is used.



To view more Timken catalogs, go to www.timken.com/catalogs for interactive versions, or to download a catalog app for your smart phone or mobile device scan the QR code or go to timkencatalogs.squawqr.com.

TIMKEN

The Timken team applies their know-how to improve the reliability and performance of machinery in diverse markets worldwide. The company designs, makes and markets high-performance mechanical components, including bearings, gears, belts, chain and related mechanical power transmission products and services.

www.timken.com

Price: USD \$75

Stronger Commitment. Stronger Value. Stronger Worldwide. Stronger Together. | Stronger By Design.